

Faster[®]

easier to connect.

Catalog

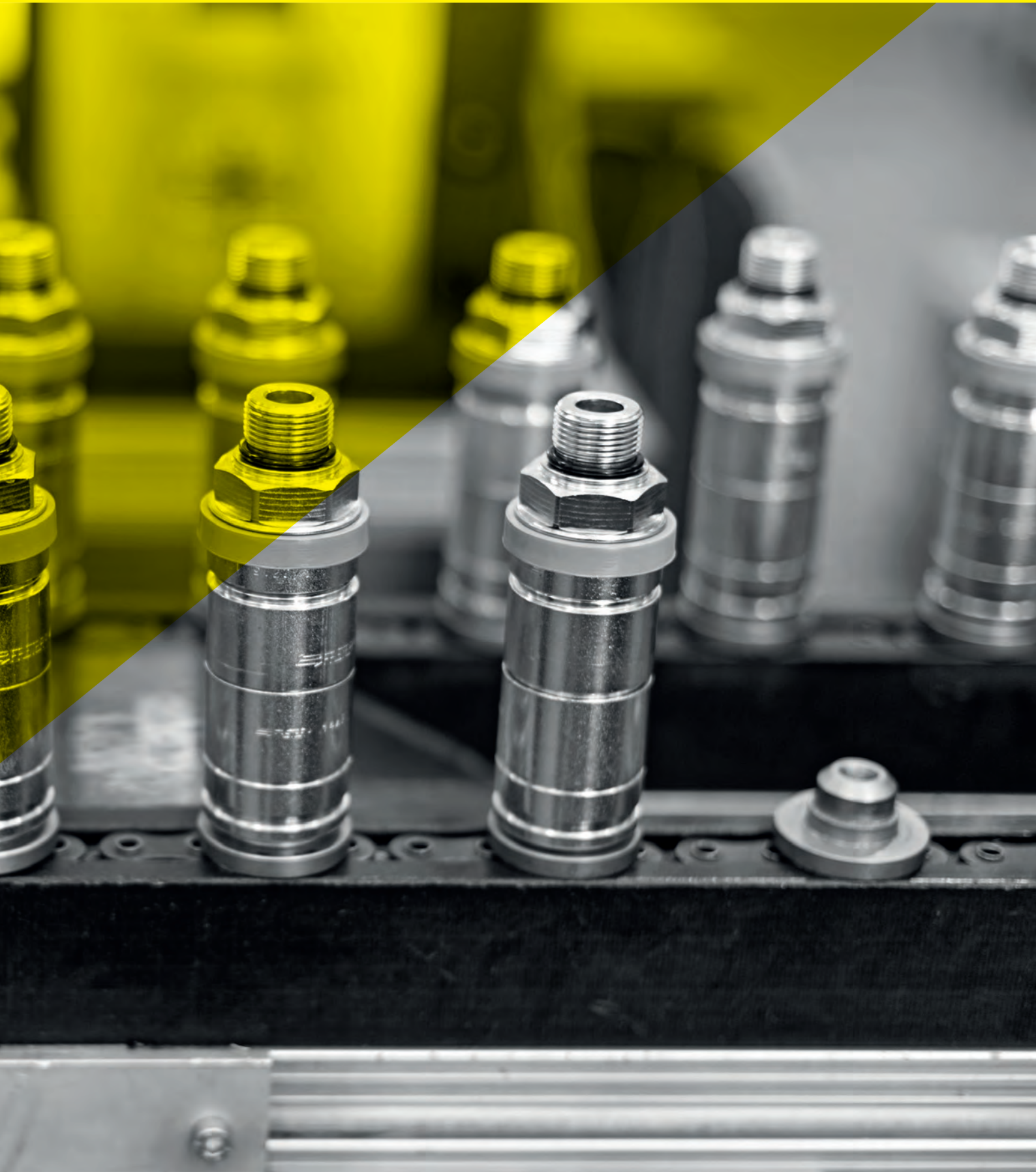

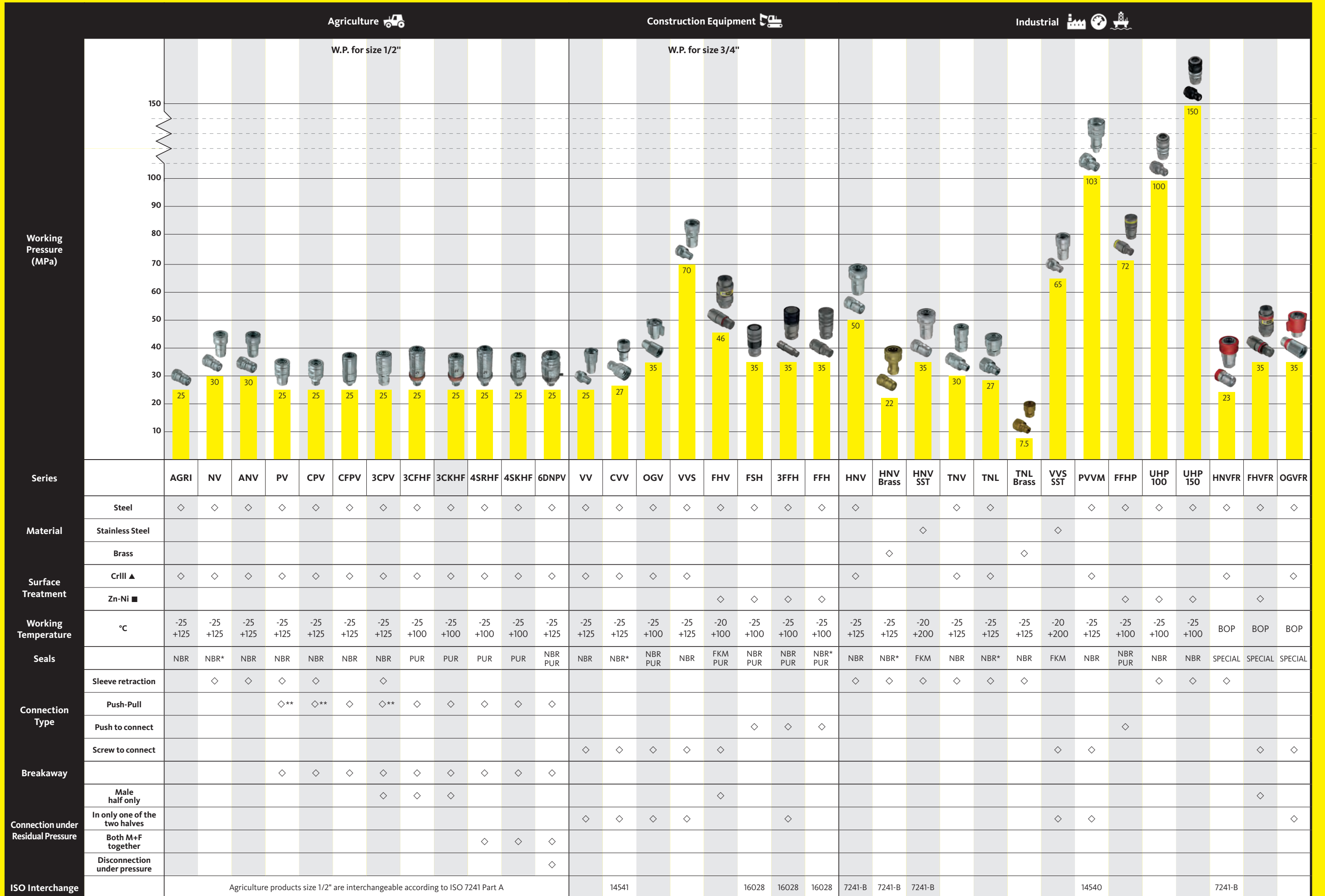

▲ 500 hours resistance to corrosion in Neutral Salt Spray test according to ISO 9227 | ■ 1000 hours resistance to corrosion in Neutral Salt Spray test according to ISO 9227 | * Part number ending in V have seals in FKM and consequently a WT of -20 °C + 200 °C | ** When panel mounted

With more than 70 years of experience in the hydraulic industry, Faster has designed and manufactured over 500 million quick-release couplings and has registered more than 100 patents.

Our product portfolio entails several solutions, grouped into 3 main areas: Single Couplings, Castings Solutions and MultiFaster. Our offer covers a wide range of applications, including Agriculture, Construction Equipment, High Pressure and Industrial. We strongly believe in continuous research for innovation. Our challenge is to increase our competitiveness by offering high quality products with agile production processes, while paying careful attention to our customers' needs. Today, Faster is a primary force for research, design and production of hydraulic quick-release couplings. Thanks to their high-level technology, our products can easily answer various market requests and meet specific requirements, set by the international standards and by different manufacturers.

Couplings _____ **6**

- Sleeve Retraction
- Agriculture
- Flat Face
- Screw to Connect
- Check Valves and Diagnostic
- High Pressure
- BOP
- Refrigeration
- Coupling Accessories

Casting Solutions _____ **264**

- 4BD4FH
- Flex Cart
- 4DCPV
- Casting for Agriculture
- 5BM5DCPV
- 4BD4FH Cartridges replacement kit

MultiFaster _____ **276**

- MultiFaster Standard
- MultiFaster Harvesting
- MultiFaster G Type
- MultiFaster High Pressure

Product Index

Sleeve Retraction

Page 6



General purpose couplings with sleeve retraction connection type. Interchangeable according to ISO A, ISO B or market standard.

Agriculture

Page 48



Couplings designed for agricultural application, interchangeable according to ISO 7241 Part A.

Flat Face

Page 120



Couplings equipped with flat-face valve to prevent spillage, therefore easier to clean.

Screw to Connect

Page 158



Screw to connect couplings, specifically designed to resist vibrations.

Check Valves and Diagnostic

Page 194



Non-returning valves used to control the oil flow in just one direction. Diagnostic: couplings used to check various points of the hydraulic system.

High Pressure

Page 206



Couplings designed for high pressures applications.

BOP

Page 218



Thanks to specific components and seals, these couplings are API certified and suitable for BOP application.

Refrigeration

Page 226



Couplings specifically designed for air conditioning and refrigeration systems.

Casting Solutions

Page 264



Castings equipped with cartridges and internal pressure eliminator.

MultiFaster

Page 276



System with lever that allows to connect several hydraulic lines simultaneously. Possibility to have electrical connection integrated.



WARNING: This product can expose you to chemicals such as Lead or Nickel which are known to the State of California to cause cancer and birth defects or other reproductive harm. For more information go to www.P65Warnings.ca.gov.

Sleeve Retraction

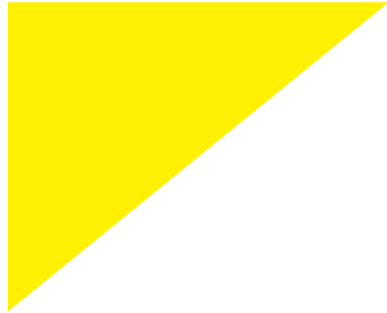

General purpose couplings with sleeve retraction connection type.
Interchangeable according to ISO A, ISO B or market standard.

NV	page 7
NV stainless steel	page 11
NS	page 13
NL	page 17
SV	page 21
HNV	page 23
HNV brass	page 27
HNV stainless steel	page 31
HNVN	page 35
4HNV	page 37
TNV	page 39
TNL	page 43
TNL brass	page 45
Couplings Accessories	page 242



NV

Standard couplings with poppet valve. Faster interchangeability (except size 1/2").

Standard couplings for general purpose applications with poppet valve shut-off system. Faster proprietary profile (1/2" size only is interchangeable according to ISO 7241 part A).



Applications



Pressure Drop

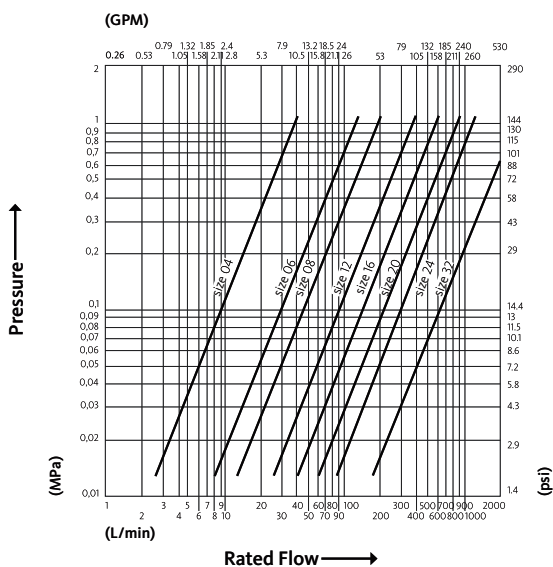

Test performed according to ISO 18869

Technical Specifications

dash	Size mm	inch	Working Pressure (MPa)	Flow Rate (l/min)	Spillage (ml)	Force to Connect (N)	Burst pressure (MPa)		
							Male	Female	Male + Female
04	6.3	1/4"	35	15	0.8	55	140	140	140
06	10	3/8"	30	50	1.3	85	120	120	140
08	12.5	1/2"	30	75	1.8	80	120	130	130
12	20	3/4"	30	150	8	150	120	120	130
16	25	1"	25	220	13	130	110	110	100
20	31.5	1-1/4"	22	340	30	145	90	90	90
24	37.5	1-1/2"	20	450	34	265	80	80	80
32	50	2"	15	1000	100	250	60	60	60

Material	Steel
Seals	NBR; VITON*
Working temperatures	- 25 °C to + 125 °C
Surface treatment	MATE 500 (CrIII)
Series Interchange	FASTER

Valve Type	Poppet
Connection	Sleeve Retraction
Disconnection	Sleeve Retraction
Connection Under Pressure	Not Allowed



* Working temperatures: - 20 °C to + 200 °C.

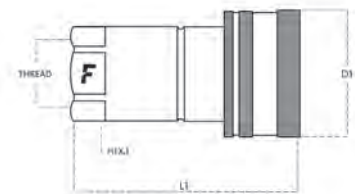

NV

Size		Thread details			FEMALE						
mm	inch	Thread Type	Standard	Thread	Part Number	L (L1 + Thread)		D1		HEX1	
						mm	inch	mm	inch	mm	inch
6.3	1/4"	O/ SAE	ISO 11926-1	9/16"-18 UNF FEMALE ORB	NV 14-38SAE F	52.5	2.07	27	1.06	19	0.75
6.3	1/4"	F NPTF	ANSI B1.20.3	NPTF 1/4" FEMALE	NV 14 NPT F	50	1.97	27	1.06	19	0.75
6.3	1/4"	F BSPP	ISO 1179-1	BSPP 1/4" FEMALE	NV 14 GAS F	50	1.97	27	1.06	19	0.75
10	3/8"	O/ SAE	ISO 11926-1	9/16"-18 UNF FEMALE ORB	NV 38-38SAE F	59.5	2.34	33	1.3	24	0.94
10	3/8"	F NPTF	ANSI B1.20.3	NPTF 3/8" FEMALE	NV 38 NPT F	59.5	2.34	33	1.3	24	0.94
10	3/8"	F BSPP	ISO 1179-1	BSPP 3/8" FEMALE	NV 38 GAS F V	59.5	2.34	33	1.3	24	0.94
10	3/8"	F BSPP	ISO 1179-1	BSPP 3/8" FEMALE	NV 38 GAS F	59.6	2.35	33	1.3	24	0.94
12.5	1/2"	O/ METRIC	ISO 6149-1	M22x1.5 FEMALE ORB	NV0/2215 F	66	2.6	38	1.5	27	1.06
12.5	1/2"	F METRIC	ISO 9974-1	M22x1.5 FEMALE	NV 2215 F	66	2.6	38	1.5	27	1.06
12.5	1/2"	O/ SAE	ISO -11926-1	7/8"-14 UNF FEMALE ORB	NV 12-58SAE F	69.5	2.74	38	1.5	32	1.26
12.5	1/2"	F BSPP	ISO 1179-1	BSPP 1/2" FEMALE	NV 12 GAS F V	66	2.6	38	1.5	27	1.06
12.5	1/2"	F NPTF	ANSI B1.20.3	NPTF 1/2" FEMALE	NV 12 NPT F	66	2.6	38	1.5	27	1.06
12.5	1/2"	F JPT	UNI EN 10226-2	RC 1/2 FEMALE (JPT)	NV 12 JPT F	66	2.6	38	1.5	27	1.06
12.5	1/2"	F BSPP	ISO 1179-1	BSPP 1/2" FEMALE	NV 12 GAS F	66	2.6	38	1.5	27	1.06
12.5	1/2"	F BSPP	ISO 1179-1	BSPP 1/2" FEMALE	NV 12 GAS F7	66	2,6	38	1,5	27	1,1
20	3/4"	F BSPP	ISO 1179-1	BSPP 3/4" FEMALE	NV 34 GAS F V	84	3.31	48	1.89	34	1.34
20	3/4"	F NPTF	ANSI B1.20.3	NPTF 3/4" FEMALE	NV 34 NPT F	83	3.27	48	1.89	34	1.34
20	3/4"	F BSPP	ISO 1179-1	BSPP 3/4" FEMALE	NV 34 GAS F	84	3.31	48	1.89	34	1.34
25	1"	F NPTF	ANSI B1.20.3	NPTF 1" FEMALE	NV 1 NPT F	99.5	3.92	56	2.2	41	1.61
25	1"	F BSPP	ISO 1179-1	BSPP 1" FEMALE	NV 1 GAS F	99.5	3.92	56	2.2	41	1.61
31.5	1-1/4"	F NPTF	ANSI B1.20.3	NPTF 1-1/4" FEMALE	NV114 NPT F	115	4.53	70	2.76	50	1.97
31.5	1-1/4"	F BSPP	ISO 1179-1	BSPP 1-1/4" FEMALE	NV114 GAS F	82.5	3.25	48	1.89	34	1.34
37.5	1-1/2"	F NPTF	ANSI B1.20.3	NPTF 1-1/2" FEMALE	NV112 NPT F	127.5	5.02	84	3.31	60	2.36
37.5	1-1/2"	F BSPP	ISO 1179-1	BSPP 1-1/2" FEMALE	NV112 GAS F	127.5	5.02	84	3.31	60	2.36
50	2"	F BSPP	ISO 1179-1	BSPP 2" FEMALE	NV 2 GAS F	151	5.94	119	4.69	75	2.95

Part number ending in V have seals in FKM and consequently a Working Temperature of - 20°C + 200 °C.
 Part Numbers ending in 7 have Zn-Ni surface treatment for improved resistance against wear and corrosion.

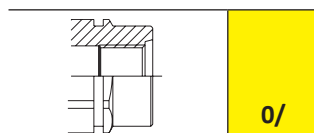
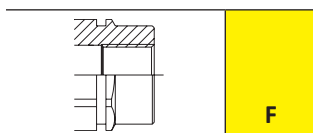

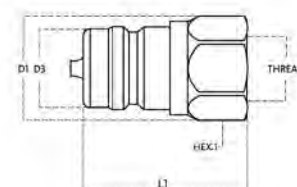

NV

Size		Thread details			MALE									
mm	inch	Thread Type	Standard	Thread	Part Number	L (L1 + Thread)		D1		D3		HEX1		
						mm	inch	mm	inch	mm	inch	mm	inch	
6.3	1/4"	O/ SAE	ISO 11926-1	9/16"-18 UNF FEMALE ORB	NV 14-38SAE M	35.5	1.4	21	0.83	14.1	0.56	19	0.75	
6.3	1/4"	F NPTF	ANSI B1.20.3	NPTF 1/4" FEMALE	NV 14 NPT M	33	1.3	21	0.83	14.1	0.56	19	0.75	
6.3	1/4"	F BSPP	ISO 1179-1	BSPP 1/4" FEMALE	NV 14 GAS M ST	34.7	1.37	21	0.83	14.1	0.56	19	0.75	
6.3	1/4"	F BSPP	ISO 1179-1	BSPP 1/4" FEMALE	NV 14 GAS M	34.7	1.37	21	0.83	14.1	0.56	19	0.75	
10	3/8"	O/ SAE	ISO 11926-1	9/16"-18 UNF FEMALE ORB	NV 38-38SAE M	39	1.54	27	1.06	18.9	0.74	24	0.94	
10	3/8"	F NPTF	ANSI B1.20.3	NPTF 3/8" FEMALE	NV 38 NPT M	39	1.54	27	1.06	18.9	0.74	24	0.94	
10	3/8"	F BSPP	ISO 1179-1	BSPP 3/8" FEMALE	NV 38 GAS M V	39	1.54	27	1.06	18.9	0.74	24	0.94	
10	3/8"	F BSPP	ISO 1179-1	BSPP 3/8" FEMALE	NV 38 GAS M	39	1.54	55	2.17	19	0.75	24	0.94	
12.5	1/2"	O/ BSPP	BS 5380	BSPP 1/2 FEMALE ORB	NV0/12 GAS M	44	1.73	30	1.18	20.5	0.81	27	1.06	
12.5	1/2"	F METRIC	ISO 9974-1	M22x1.5 FEMALE	NV 2215 M	44	1.73	30	1.18	20.5	0.81	27	1.06	
12.5	1/2"	O/ SAE	ISO 11926-1	7/8"-14 UNF FEMALE ORB	NV 12-58SAE M	51	2.01	30	1.18	20.5	0.81	27	1.06	
12.5	1/2"	O/ SAE	ISO 11926-1	3/4"-16 UNF FEMALE ORB	NV 12-12SAE M	44	1.73	30	1.18	20.5	0.81	27	1.06	
12.5	1/2"	F BSPP	ISO 1179-1	BSPP 1/2" FEMALE	NV 12 GAS M V	44	1.73	30	1.18	20.5	0.81	27	1.06	
12.5	1/2"	F NPTF	ANSI B1.20.3	NPTF 1/2" FEMALE	NV 12 NPT M	44	1.73	30	1.18	20.5	0.81	27	1.06	
12.5	1/2"	F JPT	UNI EN 10226-2	RC 1/2 FEMALE (JPT)	NV 12 JPT M	44	1.73	30	1.18	20.5	0.81	27	1.06	
12.5	1/2"	F BSPP	ISO 1179-1	BSPP 1/2" FEMALE	NV 12 GAS M	44	1.73	30	1.18	20.5	0.81	27	1.06	
20	3/4"	F NPTF	ANSI B1.20.3	NPTF 3/4" FEMALE	NV 34 NPT M	55	2.17	38	1.5	27.9	1.1	34	1.34	
20	3/4"	F BSPP	ISO 1179-1	BSPP 3/4" FEMALE	NV 34 GAS M V	55	2.17	38	1.5	27.9	1.1	34	1.34	
20	3/4"	F BSPP	ISO 1179-1	BSPP 3/4" FEMALE	NV 34 GAS M	55	2.17	38	1.5	27.9	1.1	34	1.34	
25	1"	F NPTF	ANSI B1.20.3	NPTF 1" FEMALE	NV 1 NPT M V	66	2.6	45	1.77	31.3	1.23	41	1.61	
25	1"	F NPTF	ANSI B1.20.3	NPTF 1" FEMALE	NV 1 NPT M	66	2.6	45	1.77	31.3	1.23	41	1.61	
25	1"	F BSPP	ISO 1179-1	BSPP 1" FEMALE	NV 1 GAS M	39	1.54	27	1.06	18.9	0.74	41	1.61	
31.5	1-1/4"	F NPTF	ANSI B1.20.3	NPTF 1-1/4" FEMALE	NV114 NPT M	73	2.87	55.5	2.19	43.9	1.73	50	1.97	
31.5	1-1/4"	F BSPP	ISO 1179-1	BSPP 1-1/4" FEMALE	NV114 GAS M	59.5	2.34	33	1.3	44	1.73	24	0.94	
37.5	1-1/2"	F NPTF	ANSI B1.20.3	NPTF 1-1/2" FEMALE	NV112 NPT M	83	3.27	66	2.6	53.4	2.1	60	2.36	
37.5	1-1/2"	F BSPP	ISO 1179-1	BSPP 1-1/2" FEMALE	NV112 GAS M	83	3.27	66	2.6	53.4	2.1	60	2.36	
50	2"	F BSPP	ISO 1179-1	BSPP 2" FEMALE	NV 2 GAS M	100	3.94	86.9	3.42	82	3.23	75	2.95	

Part number ending in V have seals in FKM and consequently a Working Temperature of - 20°C + 200 °C.

Part Numbers ending in 7 have Zn-Ni surface treatment for improved resistance against wear and corrosion.



NV Accessories and Spares



PVC dust protections

page 243



Aluminium dust protections

page 252

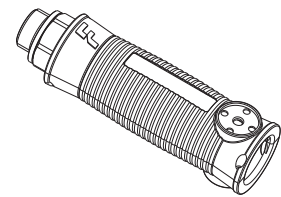

Line Identification System

page 260



Seals Kits

page 262

NV stainless steel



Standard couplings with poppet valve,
stainless steel version.

Standard couplings in stainless steel for general purpose applications with poppet valve shut-off system. ISO 7241-A interchange.



Applications



Pressure Drop

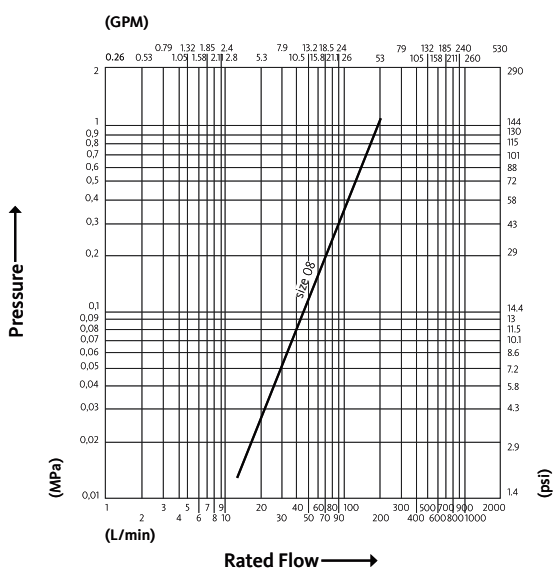

Test performed according to ISO 18869

Technical Specifications

dash	Size mm	inch	Working Pressure (MPa)	Flow Rate (l/min)	Spillage (ml)	Force to Connect (N)	Burst pressure (MPa)		
							Male	Female	Male + Female
08	12.5	1/2"	275	75	1.8	80	110	110	120

Material	Stainless Steel
Seals	FKM
Working temperatures	- 20 °C to + 200 °C
Surface treatment	No
Series Interchange	ISO 7241-A

Valve Type	Poppet
Connection	Sleeve Retraction
Disconnection	Sleeve Retraction
Connection Under Pressure	Not Allowed



* Working temperatures: - 20 °C to + 200 °C.

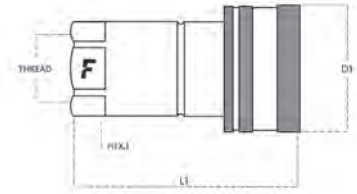

NV stainless steel

Size		Thread details			FEMALE						
mm	inch	Thread Type	Standard	Thread	Part Number	L (L1 + Thread)		D1		HEX1	
						mm	inch	mm	inch	mm	inch
13	1/2"	F BSPP	ISO 1179-1	BSPP 1/2" FEMALE	NV 12 GAS F 2V	66	2.6	38	1.5	27	1.1

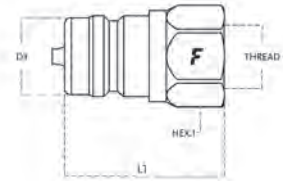

Size		Thread details			MALE								
mm	inch	Thread Type	Standard	Thread	Part Number	L (L1 + Thread)		D1		D3		HEX1	
						mm	inch	mm	inch	mm	inch	mm	inch
13	1/2"	F BSPP	ISO 1179-1	BSPP 1/2" FEMALE	NV 12 GAS M 2V	44	1.7	30	1.2	20.5	0.8	27	1.1

NV stainless steel Accessories and Spares



PVC dust protections

page 243

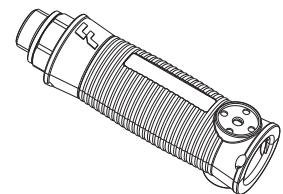

Line Identification System

page 260

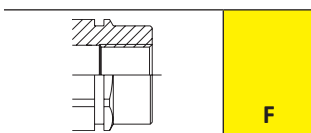

NS



**Standard couplings with ball valve.
Faster interchangeability (except size 1/2").**

Standard couplings for general purpose applications with ball valve shut-off system. Faster proprietary profile (1/2" size only is interchangeable according to ISO 7241 part A).



Applications



Pressure Drop

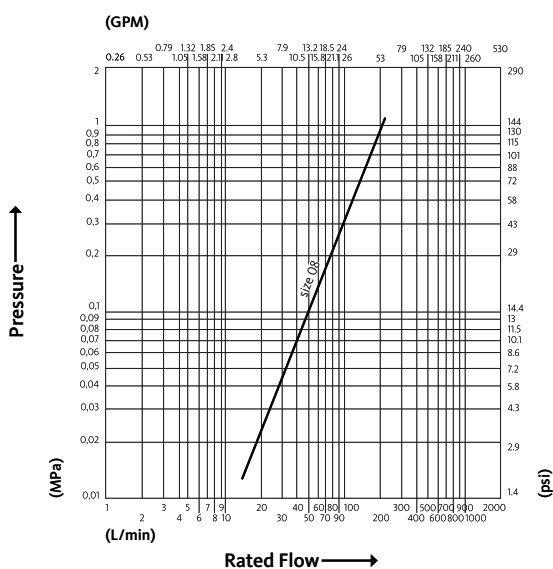

Test performed according to ISO 18869

Technical Specifications

dash	Size mm	inch	Working Pressure (MPa)	Flow Rate (l/min)	Spillage (ml)	Force to Connect (N)	Burst pressure (MPa)		
							Male	Female	Male + Female
04	6.3	1/4"	25	15	0.7	55	100	100	140
06	10	3/8"	25	30	1	85	100	100	140
08	12.5	1/2"	20	60	1.5	90	80	100	120
12	20	3/4"	17	80	7	170	68	95	150
16	25	1"	25	140	11	140	100	100	110

Material	Steel
Seals	NBR
Working temperatures	- 25 °C to + 125 °C
Surface treatment	MATE 500 (CrIII)
Series Interchange	FASTER

Valve Type	Ball
Connection	Sleeve Retraction
Disconnection	Sleeve Retraction
Connection Under Pressure	Not Allowed



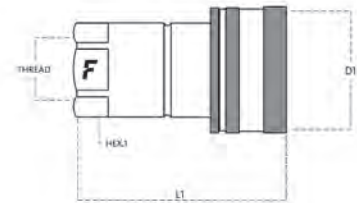

NS

Size		Thread details			FEMALE							
mm	inch	Thread Type	Standard	Thread	Part Number	L (L1 + Thread)		D1		HEX1		
						mm	inch	mm	inch	mm	inch	
6.3	1/4"	F NPTF	ANSI B1.20.3	NPTF 1/4" FEMALE	NS 14 NPT F	50	1.97	27	1.06	19	0.75	
6.3	1/4"	F BSPP	ISO 1179-1	BSPP 1/4" FEMALE	NS 14 GAS F	50	1.97	27	1.06	19	0.75	
10	3/8"	F NPTF	ANSI B1.20.3	NPTF 3/8" FEMALE	NS 38 NPT F	59.5	2.34	33	1.3	24	0.94	
10	3/8"	F BSPP	ISO 1179-1	BSPP 3/8" FEMALE	NS 38 GAS F	59.5	2.34	33	1.3	24	0.94	
12.5	1/2"	F NPTF	ANSI B1.20.3	NPTF 1/2" FEMALE	NS 12 NPT F	68	2.68	38	1.5	27	1.06	
12.5	1/2"	F BSPP	ISO 1179-1	BSPP 1/2" FEMALE	NS 12 GAS F	68	2.68	38	1.5	27	1.06	
20	3/4"	F NPTF	ANSI B1.20.3	NPTF 3/4" FEMALE	NS 34 NPT F	82	3.23	48	1.89	34	1.34	
20	3/4"	F BSPP	ISO 1179-1	BSPP 3/4" FEMALE	NS 34 GAS F	82.5	3.25	48	1.89	34	1.34	
25	1"	F NPTF	ANSI B1.20.3	NPTF 1" FEMALE	NS 1 NPT F	96.5	3.8	56	2.2	41	1.61	
25	1"	F BSPP	ISO 1179-1	BSPP 1" FEMALE	NS 1 GAS F	96.5	3.8	56	2.2	41	1.61	

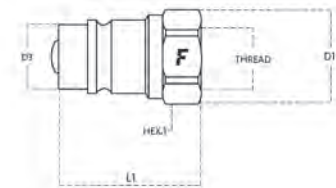

Size		Thread details			MALE									
mm	inch	Thread Type	Standard	Thread	Part Number	L (L1 + Thread)		D1		D3		HEX1		
						mm	inch	mm	inch	mm	inch	mm	inch	
6.3	1/4"	F NPTF	ANSI B1.20.3	NPTF 1/4" FEMALE	NS 14 NPT M	33	1.3	21	0.83	14.1	0.56	19	0.75	
6.3	1/4"	F BSPP	ISO 1179-1	BSPP 1/4" FEMALE	NS 14 GAS M	34.7	1.37	21	0.83	14.1	0.56	19	0.75	
10	3/8"	F NPTF	ANSI B1.20.3	NPTF 3/8" FEMALE	NS 38 NPT M	39	1.54	27	1.06	18.9	0.74	24	0.94	
10	3/8"	F BSPP	ISO 1179-1	BSPP 3/8" FEMALE	NS 38 GAS M	39	1.54	27	1.06	18.9	0.74	24	0.94	
12.5	1/2"	F NPTF	ANSI B1.20.3	NPTF 1/2" FEMALE	NS 12 NPT M	46	1.81	30	1.18	20.5	0.81	27	1.06	
12.5	1/2"	F BSPP	ISO 1179-1	BSPP 1/2" FEMALE	NS 12 GAS M	46	1.81	30	1.18	20.5	0.81	27	1.06	
12.5	1/2"	F NPTF	ANSI B1.20.3	NPTF 1/2" FEMALE	2NS 12 NPT M	47	1.85	30	1.18	20.5	0.81	27	1.06	
20	3/4"	F NPTF	ANSI B1.20.3	NPTF 3/4" FEMALE	NS 34 NPT M	53	2.09	38	1.5	27.9	1.1	34	1.34	
20	3/4"	F BSPP	ISO 1179-1	BSPP 3/4" FEMALE	NS 34 GAS M	53.5	2.11	38	1.5	27.9	1.1	34	1.34	
25	1"	F NPTF	ANSI B1.20.3	NPTF 1" FEMALE	NS 1 NPT M	63	2.48	45	1.77	31.3	1.23	41	1.61	
25	1"	F BSPP	ISO 1179-1	BSPP 1" FEMALE	NS 1 GAS M	63	2.48	45	1.77	31.3	1.23	41	1.61	

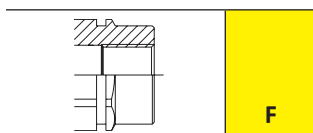

NS Accessories and Spares



PVC dust protections

page 243

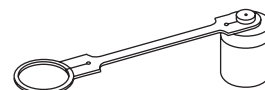
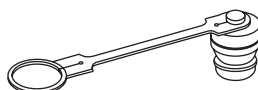

Aluminium dust protections

page 252

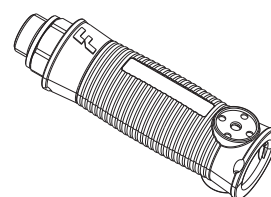

Line Identification System

page 260



Seals Kits

page 262



NL

**Standard couplings free flow.
Faster interchangeability (except size 1/2").**

NL couplings represent the free-flow version of NV series products. Purposely designed without internal valves to increase the flow rate minimizing the pressure drop.

Applications



Pressure Drop

No pressure drops detected during testing



Technical Specifications

dash	Size		Working Pressure (MPa)	Flow Rate (l/min)	Spillage (ml)	Force to Connect (N)	Burst pressure (MPa)		
	mm	inch					Male	Female	Male + Female
12	20	3/4"	30	150	0	150			130

Material	Steel
Seals	VITON
Working temperatures	- 20 °C to + 200 °C
Surface treatment	MATE 500 (CrIII)
Series Interchange	FASTER

Valve Type	None
Connection	Sleeve Retraction
Disconnection	Sleeve Retraction
Connection Under Pressure	Not Allowed



NL

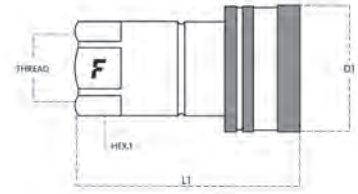

Size		Thread details			FEMALE						
mm	inch	Thread Type	Standard	Thread	Part Number	L (L1 + Thread)		D1		HEX1	
						mm	inch	mm	inch	mm	inch
20	3/4"	F BSPP	ISO 1179-1	BSPP 3/4" FEMALE	NL 34 GAS F V	84	3.31	48	1.89	34	1.34

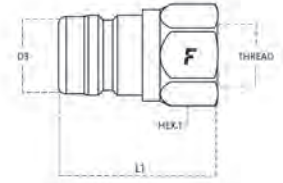

Size		Thread details			MALE								
mm	inch	Thread Type	Standard	Thread	Part Number	L (L1 + Thread)		D1		D3		HEX1	
						mm	inch	mm	inch	mm	inch	mm	inch
20	3/4"	F BSPP	ISO 1179-1	BSPP 3/4" FEMALE	NL 34 GAS M	55	2.17	38	1.5	27.9	1.1	34	1.34

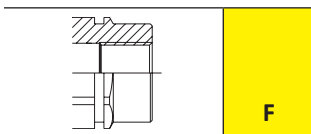

NL Accessories and Spares



PVC dust protections

page 243

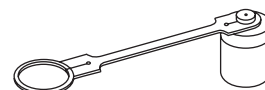

Aluminium dust protections

page 252



Seals Kits

page 262



SV

Standard female couplings with safety sleeve, poppet valve.

Standard female couplings very similar to NV series but equipped with an additional safety sleeve to prevent accidental disconnections. Poppet valve shut-off system. Interchange according to ISO 7241 part A.



Applications



Pressure Drop

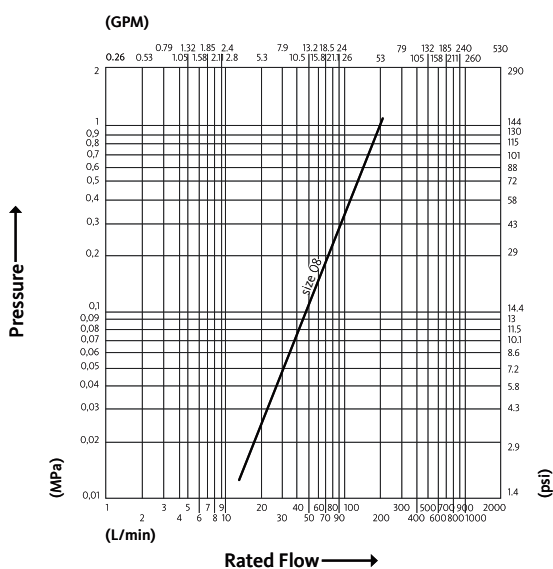

Test performed according to ISO 18869

Technical Specifications

dash	Size mm	inch	Working Pressure (MPa)	Flow Rate (l/min)	Spillage (ml)	Force to Connect (N)	Burst pressure (MPa)		
							Male	Female	Male + Female
08	12.5	1/2"	30	75	1.8	80	120	130	

Material	Steel
Seals	NBR
Working temperatures	- 25 °C to + 125 °C
Surface treatment	MATE 500 (CrIII)
Series Interchange	ISO 7241 part A

Valve Type	Poppet
Connection	Sleeve Retraction
Disconnection	Sleeve Retraction
Connection Under Pressure	Not Allowed



SV

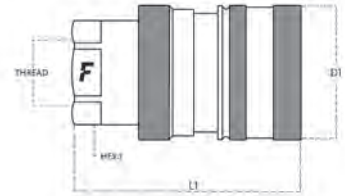

Size		Thread details			FEMALE						
mm	inch	Thread Type	Standard	Thread	Part Number	L (L1 + Thread)		D1		HEX1	
						mm	inch	mm	inch	mm	inch
12.5	1/2"	F BSPP	ISO 1179-1	BSPP 1/2" FEMALE	SV 12 GAS F	66	2.6	38	1.5	27	1.06

SV Accessories and Spares



PVC dust protections

page 243

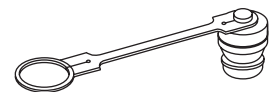

Aluminium dust protections

page 252



Seals Kits

page 262

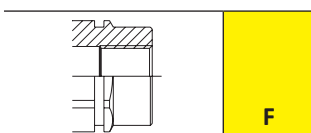

HNV

Standard couplings for industrial applications, ISO 7241 part B interchange.

Standard couplings for industrial applications. Complete range of sizes from 1/8" to 2" (with BSP, NPT and SAE female threads) available. ISO 7241 part B interchange.



Technical Specifications

dash	Size mm	inch	Working Pressure (MPa)	Flow Rate (l/min)	Spillage (ml)	Force to Connect (N)	Burst pressure (MPa)		
							Male	Female	Male + Female
02	3.2	1/8"	50	5	0.5	60	280	200	200
04	6.3	1/4"	45	17	1	65	180	200	180
06	10	3/8"	30	50	1.5	85	130	120	180
08	12.5	1/2"	35	75	2.8	97	140	140	150
12	20	3/4"	25	190	10	120	110	100	100
16	25	1"	30	270	13	180	120	120	120
24	37.5	1-1/2"	14	750	80	185	56	56	60
32	50	2"	9	1600	160	160	38	40	45

Material	Steel
Seals	NBR
Working temperatures	- 25 °C to + 125 °C
Surface treatment	MATE 500 (CrIII)
Series Interchange	ISO 7241 part B

Applications



Pressure Drop

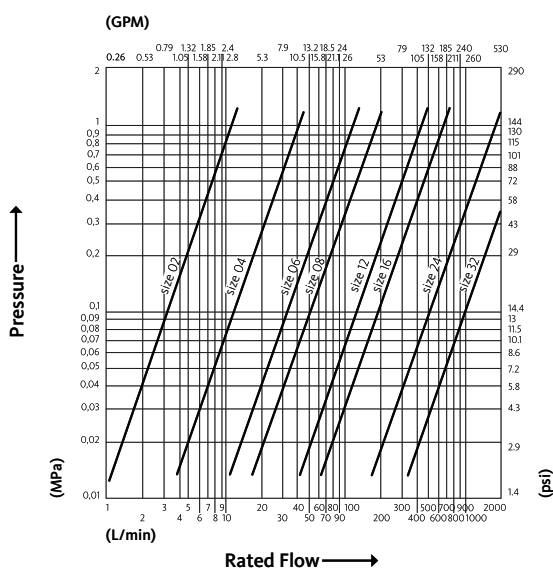

Test performed according to ISO 18869

Valve Type	Poppet
Connection	Sleeve Retraction
Disconnection	Sleeve Retraction
Connection Under Pressure	Not Allowed



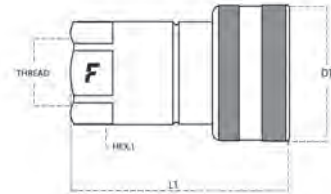

HNV

Size		Thread details			FEMALE						
mm	inch	Thread Type	Standard	Thread	Part Number	L (L1 + Thread)		D1		HEX1	
						mm	inch	mm	inch	mm	inch
3.2	1/8"	F NPTF	ANSI B1.20.3	NPTF 1/8" FEMALE	HNV 18 NPT F	50.3	1.98	23	0.91	18	0.71
3.2	1/8"	F BSPP	ISO 1179-1	BSPP 1/8" FEMALE	HNV 18 GAS F	50.3	1.98	23	0.91	18	0.71
6.3	1/4"	O/ SAE	ISO 11926-1	9/16"-18 UNF FEMALE ORB	HNV 14-38SAE F	60	2.36	28	1.1	19	0.75
6.3	1/4"	F NPTF	ANSI B1.20.3	NPTF 1/4" FEMALE	HNV 14 NPT F	56	2.2	28	1.1	19	0.75
6.3	1/4"	F BSPP	ISO 1179-1	BSPP 1/4" FEMALE	HNV 14 GAS F	56	2.2	28	1.1	19	0.75
10	3/8"	O/ SAE	ISO 11926-1	9/16"-18 UNF FEMALE ORB	HNV 38-38SAE F	64	2.52	35	1.38	24	0.94
10	3/8"	F NPTF	ANSI B1.20.3	NPTF 3/8" FEMALE	HNV 38 NPT F N	64	2.52	35	1.38	24	0.94
10	3/8"	F NPTF	ANSI B1.20.3	NPTF 3/8" FEMALE	HNV 38 NPT F	64	2.52	35	1.38	24	0.94
10	3/8"	F BSPP	ISO 1179-1	BSPP 3/8" FEMALE	HNV 38 GAS F	64	2.52	35	1.38	24	0.94
12.5	1/2"	O/ SAE	ISO 11926-1	7/8"-14 UNF FEMALE ORB	HNV 12-58SAE F	71.5	2.81	44	1.73	30	1.18
12.5	1/2"	F NPTF	ANSI B1.20.3	NPTF 1/2" FEMALE	HNV 12 NPT F	71.5	2.81	44	1.73	30	1.18
12.5	1/2"	F BSPP	ISO 1179-1	BSPP 1/2" FEMALE	HNV 12 GAS F V	71.5	2.81	44	1.73	30	1.18
12.5	1/2"	F BSPP	ISO 1179-1	BSPP 1/2" FEMALE	HNV 12 GAS F	71.5	2.81	44	1.73	30	1.18
20	3/4"	O/ SAE	ISO 11926-1	1-1/16"-12 UN FEMALE ORB	HNV 34-34SAE F	89	3.5	52	2.05	36	1.42
20	3/4"	12/ SAE	ISO 8434-3	1-3/16"-12 UN MALE BULKHEAD ORFS	HNV 34-12/34SF	146	5.75	52	2.05	36	1.42
20	3/4"	F NPTF	ANSI B1.20.3	NPTF 3/4" FEMALE	HNV 34 NPT F	89	3.5	52	2.05	36	1.42
20	3/4"	F BSPP	ISO 1179-1	BSPP 3/4" FEMALE	HNV 34 GAS F	89	3.5	52	2.05	36	1.42
25	1"	F NPTF	ANSI B1.20.3	NPTF 1" FEMALE	HNV 1 NPT F	106	4.17	62	2.44	41	1.61
25	1"	O/ SAE	ISO 11926-1	1-5/16"-12 UN FEMALE ORB	HNV 1- 1SAE F	106	4.17	62	2.44	41	1.61
25	1"	F BSPP	ISO 1179-1	BSPP 1" FEMALE	HNV 1 GAS F	106	4.17	62	2.44	41	1.61
37.5	1-1/2"	F BSPP	ISO 1179-1	BSPP 1-1/2" FEMALE	HNV112 GAS F	126.4	4.98	75	2.95	65	2.56
37.5	1-1/2"	F BSPP	ISO 1179-1	BSPP 1-1/4" FEMALE	HNV112-114GAS F	126	4.96	75	2.95	65	2.56
50	2"	F NPTF	ANSI B1.20.3	NPTF 2" FEMALE	HNV 2 NPT F	142	5.59	105	4.13	89	3.5

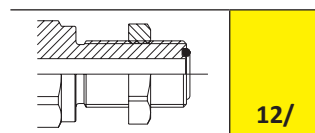
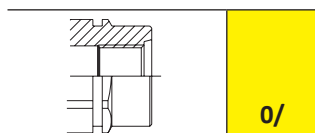
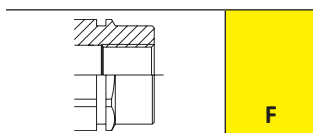

HNV

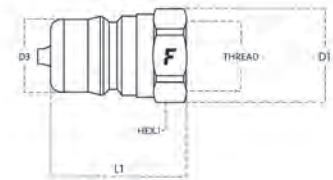

Size		Thread details			MALE									
mm	inch	Thread Type	Standard	Thread	Part Number	L (L1 + Thread)		D1		D3		HEX1		
						mm	inch	mm	inch	mm	inch	mm	inch	
3.2	1/8"	F NPTF	ANSI B1.20.3	NPTF 1/8" FEMALE	HNV 18 NPT M	31.5	1.24	19	0.75	10.8	0.43	17	0.67	
3.2	1/8"	F BSPP	ISO 1179-1	BSPP 1/8" FEMALE	HNV 18 GAS M	31.5	1.24	18.5	0.73	10.8	0.43	17	0.67	
6.3	1/4"	O/ SAE	ISO 11926-1	9/16"-18 UNF FEMALE ORB	HNV 14-38SAE M	39	1.54	21	0.83	14.1	0.56	19	0.75	
6.3	1/4"	F NPTF	ANSI B1.20.3	NPTF 1/4" FEMALE	HNV 14 NPT M	35	1.38	21	0.83	14.1	0.56	19	0.75	
6.3	1/4"	F BSPP	ISO 1179-1	BSPP 1/4" FEMALE	HNV 14 GAS M	35	1.38	21	0.83	14.1	0.56	19	0.75	
10	3/8"	O/ SAE	ISO 11926-1	9/16"-18 UNF FEMALE ORB	HNV 38-38SAE M	39	1.54	24.5	0.96	19	0.75	22	0.87	
10	3/8"	O/ SAE	ISO 11926-1	3/4"-16 UNF FEMALE ORB	HNV 38-12SAE M	45	1.77	30	1.18	19	0.75	27	1.06	
10	3/8"	F NPTF	ANSI B1.20.3	NPTF 3/8" FEMALE	HNV 38 NPT M N	39	1.54	24.5	0.96	19	0.75	22	0.87	
10	3/8"	F NPTF	ANSI B1.20.3	NPTF 3/8" FEMALE	HNV 38 NPT M	39	1.54	24.5	0.96	19	0.75	22	0.87	
10	3/8"	F BSPP	ISO 1179-1	BSPP 3/8" FEMALE	HNV 38 GAS M	39	1.54	24.5	0.96	19	0.75	22	0.87	
12.5	1/2"	O/ SAE	ISO 11926-1	7/8"-14 UNF FEMALE ORB	HNV 12-58SAE M	50	1.97	33	1.3	23.5	0.93	30	1.18	
12.5	1/2"	O/ SAE	ISO 11926-1	3/4"-16 UNF FEMALE ORB	HNV 12-12SAE M	44	1.73	30	1.18	23.5	0.93	27	1.06	
12.5	1/2"	F NPTF	ANSI B1.20.3	NPTF 1/2" FEMALE	HNV 12 NPT M	44	1.73	30	1.18	23.5	0.93	27	1.06	
12.5	1/2"	F BSPP	ISO 1179-1	BSPP 1/2" FEMALE	HNV 12 GAS M	44	1.73	30	1.18	23.5	0.93	27	1.06	
20	3/4"	O/ SAE	ISO 11926-1	1-1/16"-12 UN FEMALE ORB	HNV 34-34SAE M	55	2.17	38	1.5	31.5	1.24	34	1.34	
20	3/4"	F NPTF	ANSI B1.20.3	NPTF 3/4" FEMALE	HNV 34 NPT M	55	2.17	38	1.5	31.5	1.24	34	1.34	
20	3/4"	F BSPP	ISO 1179-1	BSPP 3/4" FEMALE	HNV 34 GAS M	55	2.17	38	1.5	31.5	1.24	34	1.34	
25	1"	F NPTF	ANSI B1.20.3	NPTF 1" FEMALE	HNV 1 NPT M	66	2.6	45	1.77	37.8	1.49	41	1.61	
25	1"	F BSPP	ISO 1179-1	BSPP 1" FEMALE	HNV 1 GAS M	66	2.6	45	1.77	37.8	1.49	41	1.61	
25	1"	O/ SAE	ISO 11926-1	1-5/16"-12 UN FEMALE ORB	HNV 1-1SAE M	66	2.6	45	1.77	37.8	1.49	41	1.61	
37.5	1-1/2"	F BSPP	ISO 1179-1	BSPP 1-1/4" FEMALE	HNV112-114GAS M	126	4.96	71	2.8	44.5	1.75	65	2.56	
37.5	1-1/2"	F BSPP	ISO 1179-1	BSPP 1-1/2" FEMALE	HNV112 GAS M	126	4.96	71	2.8	44.5	1.75	65	2.56	
50	2"	F NPTF	ANSI B1.20.3	NPTF 2" FEMALE	HNV 2 NPT M	142	5.59	97	3.82	63.25	2.49	89	3.5	

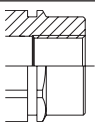

F

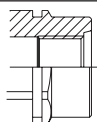

O/

HNV Accessories and Spares



PVC dust protections

page 243

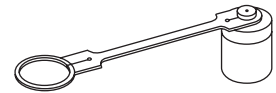
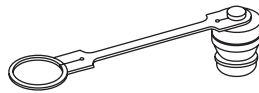

Aluminium dust protections

page 252



Seals Kits

page 262



HNV brass

Standard couplings for industrial applications, ISO 7241 part B interchange, brass versions.

Standard couplings for industrial applications with brass components. Available with NBR or Viton seals. ISO 7241 part B interchange.



Applications



Pressure Drop

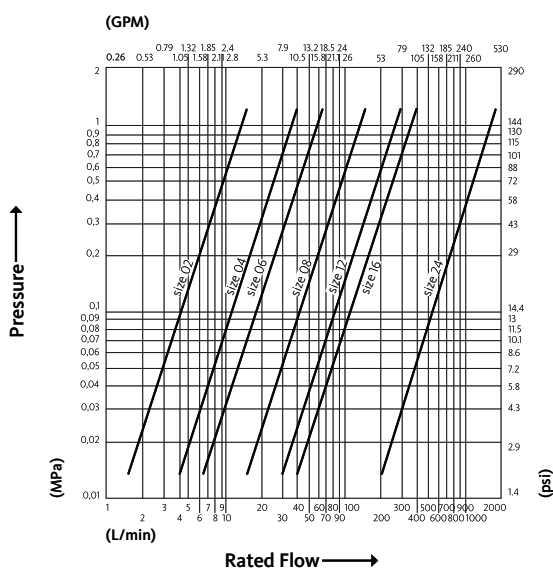

Test performed according to ISO 18869

Technical Specifications

dash	Size mm	inch	Working Pressure (MPa)	Flow Rate (l/min)	Spillage (ml)	Force to Connect (N)	Burst pressure (MPa)		
							Male	Female	Male + Female
02	3.2	1/8"	22	6	0.5	110	90	140	150
04	6.3	1/4"	20	16	1	75	80	120	120
06	10	3/8"	15	25	1.5	78	60	70	100
08	12.5	1/2"	17	60	2.8	97	70	90	90
12	20	3/4"	10	110	10	120	40	50	100
16	25	1"	14	150	13	180	56	58	80
24	37.5	1-1/2"	7	750	80	185	30	33	40

Material	Brass
Seals	NBR; VITON*
Working temperatures	- 25 °C to + 125 °C
Surface treatment	
Series Interchange	ISO 7241 part B

Valve Type	Poppet
Connection	Sleeve Retraction
Disconnection	Sleeve Retraction
Connection Under Pressure	Not Allowed



* Working temperatures: - 20 °C to + 200 °C.

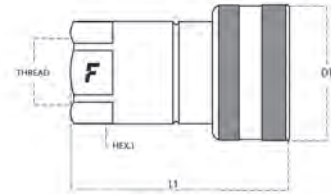

HNV brass

Size		Thread details			FEMALE						
mm	inch	Thread Type	Standard	Thread	Part Number	L (L1 + Thread)		D1		HEX1	
						mm	inch	mm	inch	mm	inch
3.2	1/8"	F NPTF	ANSI B1.20.3	NPTF 1/8" FEMALE	HNV 18 NPT F 5V	50	1.97	23	0.91	18	0.71
3.2	1/8"	F NPTF	ANSI B1.20.3	NPTF 1/8" FEMALE	HNV 18 NPT F 5	50	1.97	23	0.91	18	0.71
3.2	1/8"	F BSPP	ISO 1179-1	BSPP 1/8" FEMALE	HNV 18 GAS F 5V	50	1.97	23	0.91	18	0.71
3.2	1/8"	F BSPP	ISO 1179-1	BSPP 1/8" FEMALE	HNV 18 GAS F 5	50	1.97	23	0.91	18	0.71
6.3	1/4"	F NPTF	ANSI B1.20.3	NPTF 1/4" FEMALE	HNV 14 NPT F 5V	56	2.2	28	1.1	19	0.75
6.3	1/4"	F NPTF	ANSI B1.20.3	NPTF 1/4" FEMALE	HNV 14 NPT F 5	56	2.2	28	1.1	19	0.75
6.3	1/4"	F BSPP	ISO 1179-1	BSPP 1/4" FEMALE	HNV 14 GAS F 5V	56	2.2	28	1.1	19	0.75
6.3	1/4"	F BSPP	ISO 1179-1	BSPP 1/4" FEMALE	HNV 14 GAS F 5	56	2.2	28	1.1	19	0.75
10	3/8"	F NPTF	ANSI B1.20.3	NPTF 3/8" FEMALE	HNV 38 NPT F 5V	64	2.52	34	1.34	24	0.94
10	3/8"	F NPTF	ANSI B1.20.3	NPTF 3/8" FEMALE	HNV 38 NPT F 5	64	2.52	35	1.38	24	0.94
10	3/8"	F BSPP	ISO 1179-1	BSPP 3/8" FEMALE	HNV 38 GAS F 5V	64	2.52	35	1.38	24	0.94
10	3/8"	F BSPP	ISO 1179-1	BSPP 3/8" FEMALE	HNV 38 GAS F 5	64	2.52	35	1.38	24	0.94
12.5	1/2"	O/ SAE	ISO 11926-1	3/4"-16 UNF FEMALE ORB	HNV 12-12SAEF5V	71.5	2.81	44	1.73	30	1.18
12.5	1/2"	F NPTF	ANSI B1.20.3	NPTF 1/2" FEMALE	HNV 12 NPT F 5V	71.5	2.81	44	1.73	30	1.18
12.5	1/2"	F NPTF	ANSI B1.20.3	NPTF 1/2" FEMALE	HNV 12 NPT F 5	71.5	2.81	44	1.73	30	1.18
12.5	1/2"	F BSPP	ISO 1179-1	BSPP 1/2" FEMALE	HNV 12 GAS F 5V	71.6	2.82	44	1.73	30	1.18
12.5	1/2"	F BSPP	ISO 1179-1	BSPP 1/2" FEMALE	HNV 12 GAS F 5	71.6	2.82	44	1.73	30	1.18
20	3/4"	F NPTF	ANSI B1.20.3	NPTF 3/4" FEMALE	HNV 34 NPT F 5V	89	3.5	52	2.05	36	1.42
20	3/4"	F NPTF	ANSI B1.20.3	NPTF 3/4" FEMALE	HNV 34 NPT F 5	89	3.5	52	2.05	36	1.42
20	3/4"	F BSPP	ISO 1179-1	BSPP 3/4" FEMALE	HNV 34 GAS F 5V	89	3.5	52	2.05	36	1.42
20	3/4"	F BSPP	ISO 1179-1	BSPP 3/4" FEMALE	HNV 34 GAS F 5	89	3.5	52	2.05	36	1.42
25	1"	F NPTF	ANSI B1.20.3	NPTF 1" FEMALE	HNV 1 NPT F 5V	106	4.17	62	2.44	41	1.61
25	1"	F NPTF	ANSI B1.20.3	NPTF 1" FEMALE	HNV 1 NPT F 5	106	4.17	62	2.44	41	1.61
25	1"	F BSPP	ISO 1179-1	BSPP 1" FEMALE	HNV 1 GAS F 5V	106	4.17	62	2.44	41	1.61
25	1"	F BSPP	ISO 1179-1	BSPP 1" FEMALE	HNV 1 GAS F 5	106	4.17	62	2.44	41	1.61
37.5	1-1/2"	F NPTF	ANSI B1.20.3	NPTF 1-1/2" FEMALE	HNV112 NPT F 5	126	4.96	75	2.95	65	2.56
37.5	1-1/2"	F BSPP	ISO 1179-1	BSPP 1-1/2" FEMALE	HNV112 GAS F5V	126	4.96	75	2.95	65	2.56
37.5	1-1/2"	F BSPP	ISO 1179-1	BSPP 1-1/2" FEMALE	HNV112 GAS F 5	126	4.96	75	2.95	65	2.56

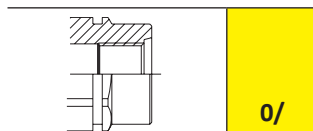
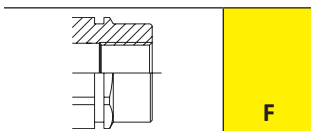

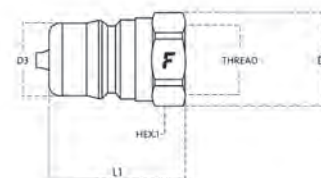

HNV brass

Size		Thread details			MALE									
mm	inch	Thread Type	Standard	Thread	Part Number	L (L1 + Thread)		D1		D3		HEX1		
						mm	inch	mm	inch	mm	inch	mm	inch	
3.2	1/8"	F NPTF	ANSI B1.20.3	NPTF 1/8" FEMALE	HNV 18 NPT M 5V	31.5	1.24	18	0.71	10.8	0.43	16	0.63	
3.2	1/8"	F NPTF	ANSI B1.20.3	NPTF 1/8" FEMALE	HNV 18 NPT M 5	31.5	1.24	18	0.71	10.8	0.43	16	0.63	
3.2	1/8"	F BSPP	ISO 1179-1	BSPP 1/8" FEMALE	HNV 18 GAS M 5V	31.5	1.24	18	0.71	10.8	0.43	18	0.71	
3.2	1/8"	F BSPP	ISO 1179-1	BSPP 1/8" FEMALE	HNV 18 GAS M 5	31.5	1.24	18	0.71	10.8	0.43	18	0.71	
6.3	1/4"	F METRIC	ISO 9974-1	M12x1 FEMALE	HNV 14-1210 M5V	35	1.38	21	0.83	14.1	0.56	19	0.75	
6.3	1/4"	F NPTF	ANSI B1.20.3	NPTF 1/4" FEMALE	HNV 14 NPT M 5V	35	1.38	21	0.83	14.1	0.56	19	0.75	
6.3	1/4"	F NPTF	ANSI B1.20.3	NPTF 1/4" FEMALE	HNV 14 NPT M 5	35	1.38	21	0.83	14.1	0.56	19	0.75	
6.3	1/4"	F BSPP	ISO 1179-1	BSPP 1/4" FEMALE	HNV 14 GAS M 5V	35	1.38	21	0.83	14.1	0.56	19	0.75	
6.3	1/4"	F BSPP	ISO 1179-1	BSPP 1/4" FEMALE	HNV 14 GAS M 5	35	1.38	21	0.83	14.1	0.56	19	0.75	
10	3/8"	F NPTF	ANSI B1.20.3	NPTF 3/8" FEMALE	HNV 38 NPT M 5V	39	1.54	24.5	0.96	19	0.75	22	0.87	
10	3/8"	F NPTF	ANSI B1.20.3	NPTF 3/8" FEMALE	HNV 38 NPT M 5	39	1.54	24.5	0.96	19	0.75	22	0.87	
10	3/8"	F BSPP	ISO 1179-1	BSPP 3/8" FEMALE	HNV 38 GAS M 5V	39	1.54	24.5	0.96	19	0.75	22	0.87	
10	3/8"	F BSPP	ISO 1179-1	BSPP 3/8" FEMALE	HNV 38 GAS M 5	39	1.54	24.5	0.96	19	0.75	24	0.94	
12.5	1/2"	F NPTF	ANSI B1.20.3	NPTF 1/2" FEMALE	HNV 12 NPT M 5V	44	1.73	30	1.18	23.5	0.93	27	1.06	
12.5	1/2"	F NPTF	ANSI B1.20.3	NPTF 1/2" FEMALE	HNV 12 NPT M 5	44	1.73	30	1.18	23.5	0.93	27	1.06	
12.5	1/2"	F BSPP	ISO 1179-1	BSPP 1/2" FEMALE	HNV 12 GAS M 5V	44	1.73	30	1.18	23.5	0.93	27	1.06	
12.5	1/2"	F BSPP	ISO 1179-1	BSPP 1/2" FEMALE	HNV 12 GAS M 5	44	1.73	30	1.18	23.5	0.93	27	1.06	
20	3/4"	F NPTF	ANSI B1.20.3	NPTF 3/4" FEMALE	HNV 34 NPT M 5V	55	2.17	38	1.5	31.5	1.24	34	1.34	
20	3/4"	F NPTF	ANSI B1.20.3	NPTF 3/4" FEMALE	HNV 34 NPT M 5	55	2.17	38	1.5	31.5	1.24	34	1.34	
20	3/4"	F BSPP	ISO 1179-1	BSPP 3/4" FEMALE	HNV 34 GAS M 5V	55	2.17	38	1.5	31.5	1.24	34	1.34	
20	3/4"	F BSPP	ISO 1179-1	BSPP 3/4" FEMALE	HNV 34 GAS M 5	55	2.17	38	1.5	31.5	1.24	34	1.34	
25	1"	F NPTF	ANSI B1.20.3	NPTF 1" FEMALE	HNV 1 NPT M 5V	66	2.6	45	1.77	37.8	1.49	41	1.61	
25	1"	F BSPP	ISO 1179-1	BSPP 1" FEMALE	HNV 1 GAS M 5V	66	2.6	45	1.77	37.8	1.49	41	1.61	
25	1"	F BSPP	ISO 1179-1	BSPP 1" FEMALE	HNV 1 GAS M 5	66	2.6	45	1.77	37.8	1.49	41	1.61	
37.5	1-1/2"	F NPTF	ANSI B1.20.3	NPTF 1-1/2" FEMALE	HNV112 NPT M 5	123.5	4.86	70	2.76	44.5	1.75	65	2.56	
37.5	1-1/2"	F BSPP	ISO 1179-1	BSPP 1-1/2" FEMALE	HNV112 GAS M 5V	123.5	4.86	70	2.76	44.5	1.75	65	2.56	
37.5	1-1/2"	F BSPP	ISO 1179-1	BSPP 1-1/2" FEMALE	HNV112 GAS M 5	123.5	4.86	70	2.76	44.5	1.75	65	2.56	

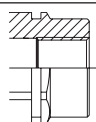

F

HNV brass Accessories and Spares



PVC dust protections

page 243

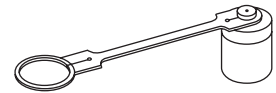
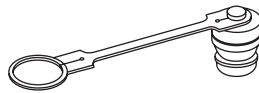

Aluminium dust protections

page 252

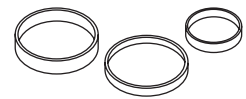

Seals Kits

page 262



HNV stainless steel

Standard couplings for industrial applications, ISO 7241 part B interchange, stainless steel versions.

Standard couplings for industrial applications with stainless steel components (AISI 316) and Viton seals. ISO 7241 part B interchange.



Applications



Pressure Drop

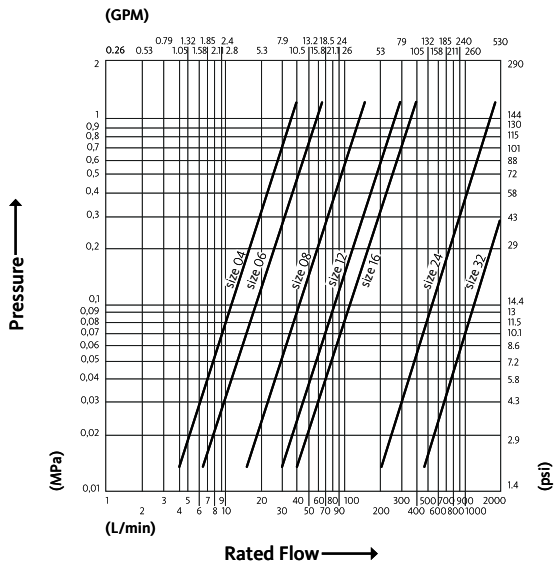

Test performed according to ISO 18869

Technical Specifications

dash	Size mm	inch	Working Pressure (MPa)	Flow Rate (l/min)	Spillage (ml)	Force to Connect (N)	Burst pressure (MPa)		
							Male	Female	Male + Female
04	6.3	1/4"	35	14	1	65	140	200	200
06	10	3/8"	27	27	1.5	85	110	110	160
08	12.5	1/2"	32	60	2.8	97	150	130	130
12	20	3/4"	25	110	10	120	100	100	165
16	25	1"	21	150	13	180	84	90	100
24	37.5	1-1/2"	14	750	80	185	56	56	60
32	50	2"	9	1600	160	160	38	40	45

Material	Stainless Steel
Seals	VITON
Working temperatures	- 20 °C to + 200 °C
Surface treatment	
Series Interchange	ISO 7241 part B

Valve Type	Poppet
Connection	Sleeve Retraction
Disconnection	Sleeve Retraction
Connection Under Pressure	Not Allowed



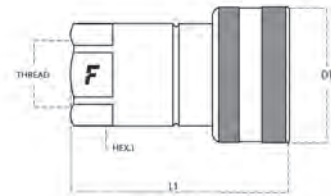

HNV stainless steel

Size		Thread details			FEMALE							
mm	inch	Thread Type	Standard	Thread	Part Number	L (L1 + Thread)		D1		HEX1		
						mm	inch	mm	inch	mm	inch	
6.3	1/4"	F NPTF	ANSI B1.20.3	NPTF 1/4" FEMALE	HNV 14 NPT F 2V	56	2.2	28	1.1	19	0.75	
6.3	1/4"	F BSPP	ISO 1179-1	BSPP 1/4" FEMALE	HNV 14 GAS F 2V	56	2.2	28	1.1	19	0.75	
10	3/8"	F NPTF	ANSI B1.20.3	NPTF 3/8" FEMALE	HNV 38 NPT F 2V	64	2.52	35	1.38	24	0.94	
10	3/8"	F BSPP	ISO 1179-1	BSPP 3/8" FEMALE	HNV 38 GAS F 2V	64	2.52	35	1.38	24	0.94	
12.5	1/2"	F BSPP	ISO 1179-1	BSPP 1/2" FEMALE	HNV 12 GAS F 2V	71.5	2.81	44	1.73	30	1.18	
12.5	1/2"	F NPTF	ANSI B1.20.3	NPTF 1/2" FEMALE	HNV 12 NPT F 2V	71.5	2.81	44	1.73	27	1.06	
20	3/4"	F BSPP	ISO 1179-1	BSPP 3/4" FEMALE	HNV 34 GAS F 2V	89	3.5	52	2.05	36	1.42	
20	3/4"	F NPTF	ANSI B1.20.3	NPTF 3/4" FEMALE	HNV 34 NPT F 2V	89	3.5	52	2.05	36	1.42	
25	1"	F BSPP	ISO 1179-1	BSPP 1" FEMALE	HNV 1 GAS F 2V	106.3	4.19	60	2.36	41	1.61	
25	1"	F NPTF	ANSI B1.20.3	NPTF 1" FEMALE	HNV 1 NPT F 2V	106	4.17	60	2.36	41	1.61	
37.5	1-1/2"	F NPTF	ANSI B1.20.3	NPTF 1-1/4" FEMALE	HNV112-114N F2V	126	4.96	75	2.95	65	2.56	
37.5	1-1/2"	F BSPP	ISO 1179-1	BSPP 1-1/4" FEMALE	HNV112-114G F2V	126	4.96	75	2.95	65	2.56	
37.5	1-1/2"	F NPTF	ANSI B1.20.3	NPTF 1-1/2" FEMALE	HNV112 NPT F 2V	126.3	4.97	75	2.95	65	2.56	
50	2"	F NPTF	ANSI B1.20.3	NPTF 2" FEMALE	HNV 2 NPT F 2V	142	5.59	105	4.13	89	3.5	
50	2"	F BSPP	ISO 1179-1	BSPP 2" FEMALE	HNV 2 GAS F 2V	142	5.59	105	4.13	89	3.5	

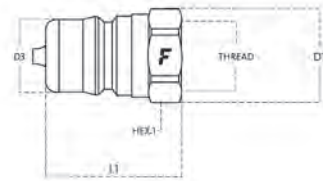

Size		Thread details			MALE								
mm	inch	Thread Type	Standard	Thread	Part Number	L (L1 + Thread)		D1		D3		HEX1	
						mm	inch	mm	inch	mm	inch	mm	inch
6.3	1/4"	F NPTF	ANSI B1.20.3	NPTF 1/4" FEMALE	HNV 14 NPT M 2V	35	1.38	21	0.83	14.1	0.56	19	0.75
6.3	1/4"	F BSPP	ISO 1179-1	BSPP 1/4" FEMALE	HNV 14 GAS M 2V	35	1.38	21	0.83	14.1	0.56	19	0.75
10	3/8"	F NPTF	ANSI B1.20.3	NPTF 3/8" FEMALE	HNV 38 NPT M 2V	39	1.54	24.5	0.96	19	0.75	22	0.87
10	3/8"	F BSPP	ISO 1179-1	BSPP 3/8" FEMALE	HNV 38 GAS M 2V	39	1.54	24.5	0.96	19	0.75	22	0.87
12.5	1/2"	F NPTF	ANSI B1.20.3	NPTF 1/2" FEMALE	HNV 12 NPT M 2V	44	1.73	30	1.18	23.5	0.93	27	1.06
12.5	1/2"	F BSPP	ISO 1179-1	BSPP 1/2" FEMALE	HNV 12 GAS M 2V	44	1.73	30	1.18	23.5	0.93	27	1.06
20	3/4"	F NPTF	ANSI B1.20.3	NPTF 3/4" FEMALE	HNV 34 NPT M 2V	55	2.17	38	1.5	31.5	1.24	34	1.34
20	3/4"	F BSPP	ISO 1179-1	BSPP 3/4" FEMALE	HNV 34 GAS M 2V	55	2.17	38	1.5	31.5	1.24	34	1.34
25	1"	F NPTF	ANSI B1.20.3	NPTF 1" FEMALE	HNV 1 NPT M 2V	66	2.6	45	1.77	37.8	1.49	41	1.61
25	1"	F BSPP	ISO 1179-1	BSPP 1" FEMALE	HNV 1 GAS M 2V	66	2.6	45	1.77	37.8	1.49	41	1.61
37.5	1-1/2"	F NPTF	ANSI B1.20.3	NPTF 1-1/4" FEMALE	HNV112-114N M2V	126	4.96	70	2.76	44.5	1.75	65	2.56
37.5	1-1/2"	F BSPP	ISO 1179-1	BSPP 1-1/4" FEMALE	HNV112-114G M2V	126	4.96	70	2.76	44.5	1.75	65	2.56
37.5	1-1/2"	F NPTF	ANSI B1.20.3	NPTF 1-1/2" FEMALE	HNV112 NPT M 2V	125	4.92	71	2.8	44.5	1.75	65	2.56
50	2"	F NPTF	ANSI B1.20.3	NPTF 2" FEMALE	HNV 2 NPT M 2V	142	5.59	97	3.82	63.2	2.49	89	3.5
50	2"	F BSPP	ISO 1179-1	BSPP 2" FEMALE	HNV 2 GAS M 2V	142	5.59	97	3.82	63.2	2.49	89	3.5

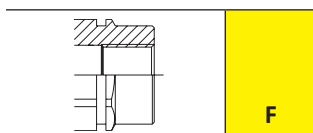

HNV stainless steel Accessories and Spares



PVC dust protections

page 243

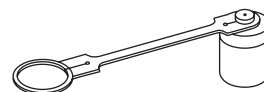
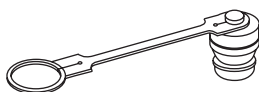

Aluminium dust protections

page 252



Seals Kits

page 262

HNVN



Standard couplings for industrial applications, Japanese market interchange.

Standard couplings for industrial applications, interchangeable for Japanese market.



Applications



Pressure Drop

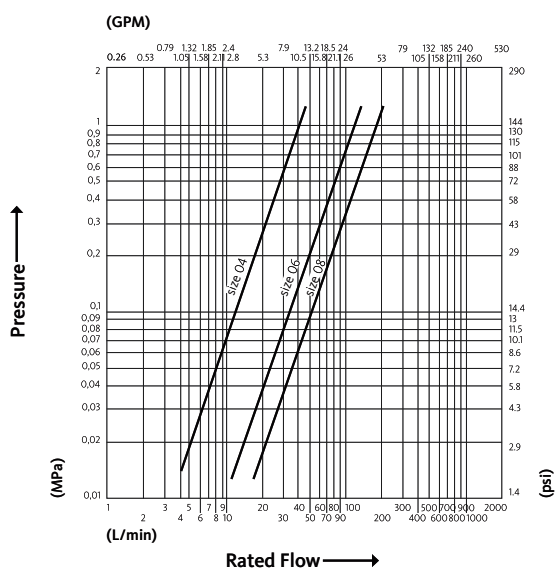

Test performed according to ISO 18869

Technical Specifications

dash	Size mm	inch	Working Pressure (MPa)	Flow Rate (l/min)	Spillage (ml)	Force to Connect (N)	Burst pressure (MPa)		
							Male	Female	Male + Female
04	6.3	1/4"	45	17	1	65	180	200	180
06	10	3/8"	30	50	1.5	85	130	120	180
08	12.5	1/2"	35	75	2.8	97	140	140	150

Material	Steel
Seals	NBR
Working temperatures	- 25 °C to + 125 °C
Surface treatment	MATE 500 (CrIII)
Series Interchange	MARKET

Valve Type	Poppet
Connection	Sleeve Retraction
Disconnection	Sleeve Retraction
Connection Under Pressure	Not Allowed



HNVN

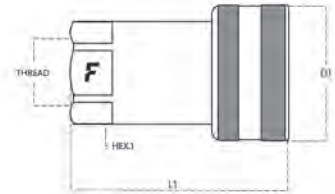

Size		Thread details			FEMALE						
mm	inch	Thread Type	Standard	Thread	Part Number	L (L1 + Thread)		D1		HEX1	
						mm	inch	mm	inch	mm	inch
6.3	1/4"	F JPT	UNI EN 10226-2	RC 1/4 FEMALE (JPT)	HNVN 14 JPT F	51	2.01	28.2	1.11	19	0.75
6.3	1/4"	F BSPP	ISO 1179-1	BSPP 1/4" FEMALE	HNVN 14 GAS F	51	2.01	28.2	1.11	19	0.75
10	3/8"	F BSPP	ISO 1179-1	BSPP 3/8" FEMALE	HNVN 38 GAS F	64	2.52	35	1.38	24	0.94
12.5	1/2"	F JPT	UNI EN 10226-2	RC 1/2 FEMALE (JPT)	HNVN 12 JPT F	71	2.8	44	1.73	30	1.18
12.5	1/2"	F BSPP	ISO 1179-1	BSPP 3/4" FEMALE	HNVN 12 GAS F	71	2.8	44	1.73	30	1.18

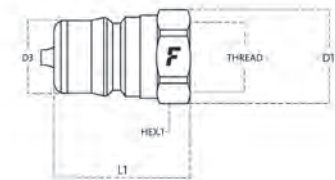

Size		Thread details			MALE								
mm	inch	Thread Type	Standard	Thread	Part Number	L (L1 + Thread)		D1		D3		HEX1	
						mm	inch	mm	inch	mm	inch	mm	inch
6.3	1/4"	F JPT	UNI EN 10226-2	RC 1/4 FEMALE (JPT)	HNVN 14 JPT M	33	1.3	21	0.83	14.2	0.56	19	0.75
6.3	1/4"	F BSPP	ISO 1179-1	BSPP 1/4" FEMALE	HNVN 14 GAS M	33	1.3	21	0.83	14.2	0.56	19	0.75
10	3/8"	F BSPP	ISO 1179-1	BSPP 3/8" FEMALE	HNVN 38 GAS M	39	1.54	24.5	0.96	18.2	0.72	22	0.87
12.5	1/2"	F JPT	UNI EN 10226-2	RC 1/2 FEMALE (JPT)	HNVN 12 JPT M	44	1.73	30	1.18	24.3	0.96	27	1.06
12.5	1/2"	F BSPP	ISO 1179-1	BSPP 3/4" FEMALE	HNVN 12 GAS M	44	1.73	30	1.18	24.3	0.96	27	1.06

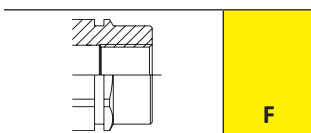



4HNV

Standard couplings for industrial application with pressure relief valve. ISO 7241 B interchange.

Standard couplings for industrial applications allowing an easy relief of residual pressure thanks to a microvalve. ISO 7241 part B interchange.



Applications



Pressure Drop

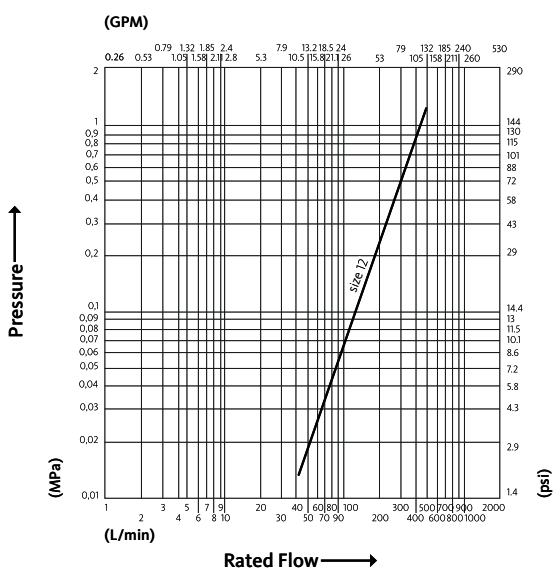

Test performed according to ISO 18869

Technical Specifications

dash	Size mm	inch	Working Pressure (MPa)	Flow Rate (l/min)	Spillage (ml)	Force to Connect (N)	Burst pressure (MPa)		
							Male	Female	Male + Female
12	20	3/4"	25	190	10	110	100	100	100

Material	Steel
Seals	NBR
Working temperatures	- 25 °C to + 125 °C
Surface treatment	MATE 500 (CrIII)
Series Interchange	ISO 7241 part B

Valve Type	Poppet
Connection	Push to Connect
Disconnection	Pull to Disconnect
Connection Under Pressure	Allowed Both Halves up to W.P.



4HNV

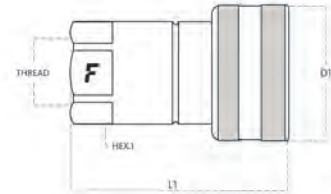

Size		Thread details			FEMALE						
mm	inch	Thread Type	Standard	Thread	Part Number	L (L1 + Thread)		D1		HEX1	
						mm	inch	mm	inch	mm	inch
20	3/4"	F NPTF	ANSI B1.20.3	NPTF 3/4" FEMALE	4HNV 34 NPT F	89	3.50	52	2.05	36	1.42

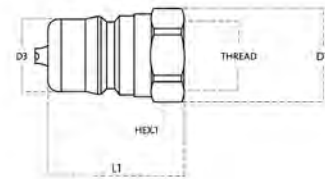

Size		Thread details			MALE								
mm	inch	Thread Type	Standard	Thread	Part Number	L (L1 + Thread)		D1		D3		HEX1	
						mm	inch	mm	inch	mm	inch	mm	inch
20	3/4"	F NPTF	ANSI B1.20.3	NPTF 3/4" FEMALE	4HNV 34 NPT M	55	2.17	38	1.50	31.5	1.24	34	1.34

4HNV Accessories and Spares



PVC dust protections

page 243

Aluminium dust protections

page 252

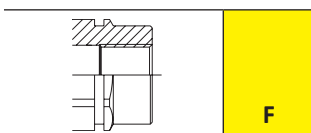



TNV

Standard couplings, US interchange.

TNV series couplings are commonly used in US market as an alternative to standard series. Their valves have been designed to help flow and to allow connection with TNL parts (free flow) same series.



Applications



Pressure Drop

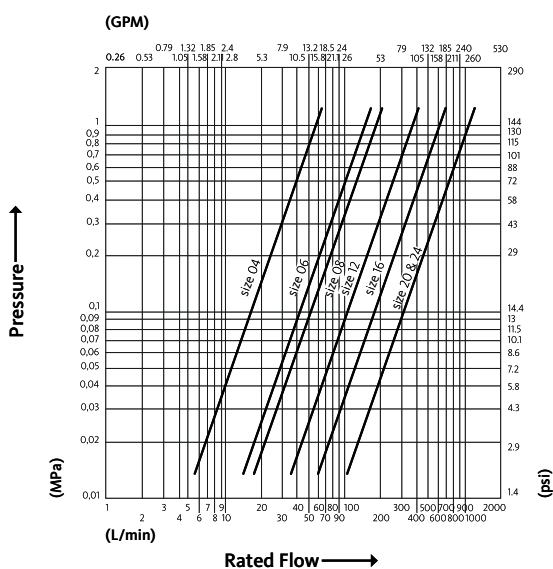

Test performed according to ISO 18869

Technical Specifications

dash	Size mm	inch	Working Pressure (MPa)	Flow Rate (l/min)	Spillage (ml)	Force to Connect (N)	Burst pressure (MPa)		
							Male	Female	Male + Female
04	6.3	1/4"	27	22	2	60	140	130	125
06	10	3/8"	30	45	3	70	180	170	170
08	12.5	1/2"	22	80	4	92	100	88	88
12	20	3/4"	19	190	14	110	76	70	70
16	25	1"	15	280	20	100	60	60	60
20	31.5	1-1/4"	10	450	45	110	50	50	40
24	37.5	1-1/2"	11	450	80	150	45	45	45

Material	Steel
Seals	NBR
Working temperatures	- 25 °C to + 125 °C
Surface treatment	MATE 500 (CrIII)
Series Interchange	MARKET

Valve Type	Poppet
Connection	Sleeve Retraction
Disconnection	Sleeve Retraction
Connection Under Pressure	Not Allowed



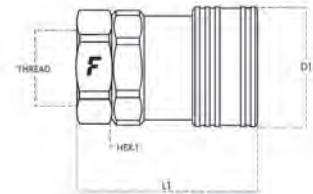

Size		Thread details			FEMALE						
mm	inch	Thread Type	Standard	Thread	Part Number	L (L1 + Thread)		D1		HEX1	
						mm	inch	mm	inch	mm	inch
6.3	1/4"	F NPTF	ANSI B1.20.3	NPTF 1/4" FEMALE	TNV 04 NPT F	50	1.97	24	0.94	22	0.87
10	3/8"	F NPTF	ANSI B1.20.3	NPTF 3/8" FEMALE	TNV 06 NPT F	57	2.24	27	1.06	24	0.94
12.5	1/2"	F NPTF	ANSI B1.20.3	NPTF 1/2" FEMALE	TNV 08 NPT F	65	2.56	34	1.34	30	1.18
20	3/4"	O/ BSPP	BS 5380	BSPP 3/4 FEMALE ORB	TNV120/34GAS F	85.5	3.37	42	1.65	34	1.34
20	3/4"	O/ SAE	ISO 11926-1	1-1/16"-12 UN FEMALE ORB	TNV120/1116UN F	85.5	3.37	42	1.65	34	1.34
20	3/4"	F NPTF	ANSI B1.20.3	NPTF 3/4" FEMALE	TNV 12 NPT F	64	2.52	42	1.65	36	1.42
25	1"	O/ BSPP	BS 5380	BSPP 1 FEMALE ORB	TNV160/1GAS F	71	2.80	50.5	1.99	46	1.81
25	1"	F NPTF	ANSI B1.20.3	NPTF 1" FEMALE	TNV 16 NPT F	71	2.80	50.5	1.99	46	1.81
31.5	1-1/4"	F NPTF	ANSI B1.20.3	NPTF 1-1/4" FEMALE	TNV 20 NPT F	97	3.82	56	2.20	50	1.97
37.5	1-1/2"	F NPTF	ANSI B1.20.3	NPTF 1-1/2" FEMALE	TNV 24 NPT F	91	3.58	70	2.76	65	2.56

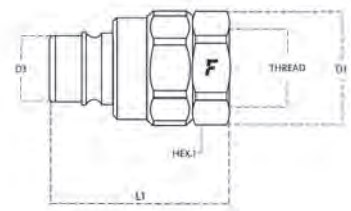

Size		Thread details			MALE								
mm	inch	Thread Type	Standard	Thread	Part Number	L (L1 + Thread)		D1		D3		HEX1	
						mm	inch	mm	inch	mm	inch	mm	inch
6.3	1/4"	F NPTF	ANSI B1.20.3	NPTF 1/4" FEMALE	TNV 04 NPT M	49	1.93	24	0.94	10.8	0.43	21	0.83
10	3/8"	F NPTF	ANSI B1.20.3	NPTF 3/8" FEMALE	TNV 06 NPT M	57	2.24	27	1.06	12.9	0.51	24	0.94
12.5	1/2"	F NPTF	ANSI B1.20.3	NPTF 1/2" FEMALE	TNV 08 NPT M	63	2.48	34	1.34	16	0.63	30	1.18
20	3/4"	O1/ SAE	ISO 6149-2	1-1/16"-12 UN MALE JIC	TNV121/1116UN M	85.5	3.37	40	1.57	23.3	0.92	36	1.42
20	3/4"	O/ BSPP	BS 5380	BSPP 3/4 FEMALE ORB	TNV120/34GAS M	64	2.52	40	1.57	23.3	0.92	36	1.42
20	3/4"	O/ SAE	ISO 11926-1	1-1/16"-12 UN FEMALE ORB	TNV120/1116UN M	64	2.52	40	1.57	23.3	0.92	36	1.42
20	3/4"	F NPTF	ANSI B1.20.3	NPTF 3/4" FEMALE	TNV 12 NPT M	63.5	2.50	40	1.57	23.3	0.92	36	1.42
25	1"	O/ BSPP	BS 5380	BSPP 1 FEMALE ORB	TNV160/1GAS M	68	2.68	50.5	1.99	29.7	1.17	46	1.81
25	1"	F NPTF	ANSI B1.20.3	NPTF 1" FEMALE	TNV 16 NPT M	68	2.68	50.5	1.99	29.7	1.17	46	1.81
31.5	1-1/4"	F NPTF	ANSI B1.20.3	NPTF 1-1/4" FEMALE	TNV 20 NPT M	91	3.58	56	2.20	36.1	1.42	50	1.97
37.5	1-1/2"	F NPTF	ANSI B1.20.3	NPTF 1-1/2" FEMALE	TNV 24 NPT M	85	3.35	70	2.76	43.5	1.71	65	2.56

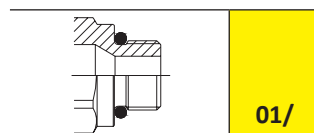
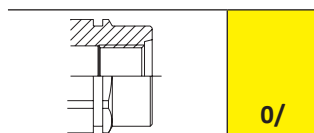
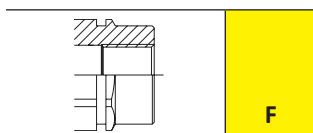

TNV Accessories and Spares



PVC dust protections

page 243



Seals Kits

page 262

TNL



Standard couplings, US interchange, free flow.

TNL series couplings are commonly used in US market as an alternative to standard series. Assembled without internal valves they have been designed to maximize flow. Fully interchangeable with TNV version.



Applications



Pressure Drop

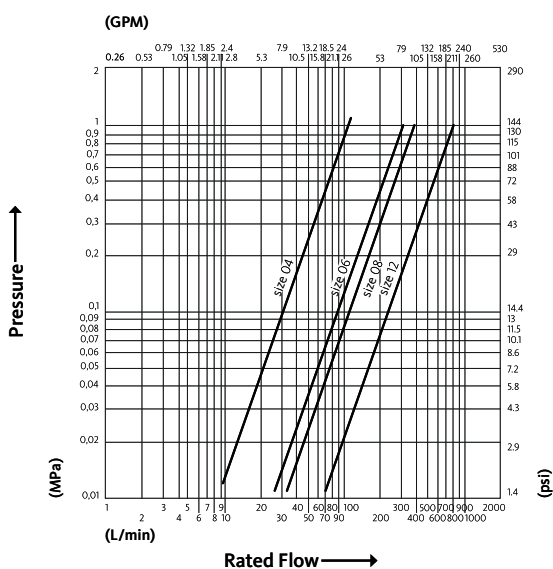

Technical Specifications

dash	Size mm	inch	Working Pressure (MPa)	Flow Rate (l/min)	Spillage (ml)	Force to Connect (N)	Burst pressure (MPa)		
							Male	Female	Male + Female
04	6.3	1/4"	27	32	0	35		110	
06	10	3/8"	30	55	0	58		160	
08	12.5	1/2"	22	75	0	92		140	
12	20	3/4"	19	170	0	110		170	

Material	Steel
Seals	NBR; VITON*
Working temperatures	- 25 °C to + 125 °C
Surface treatment	MATE 500 (CrIII)
Series Interchange	MARKET

Valve Type	None
Connection	Sleeve Retraction
Disconnection	Sleeve Retraction
Connection Under Pressure	Not Allowed



* Working temperatures: - 20 °C to + 200 °C.

TNL

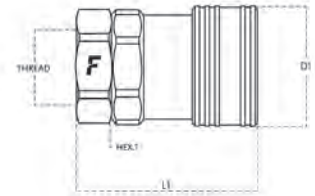

Size		Thread details			FEMALE						
mm	inch	Thread Type	Standard	Thread	Part Number	L (L1 + Thread)		D1		HEX1	
						mm	inch	mm	inch	mm	inch
6.3	1/4"	F NPTF	ANSI B1.20.3	NPTF 1/4" FEMALE	TNL 04 NPT F	50	1.97	24	0.94	22	0.87
12.5	1/2"	F NPTF	ANSI B1.20.3	NPTF 1/2" FEMALE	TNL 08 NPT F	40	1.57	29.6	1.17	27	1.06
12.5	1/2"	F BSPP	ISO 1179-1	BSPP 1/2" FEMALE	TNL 08 GAS F	40	1.57	29.6	1.17	27	1.06
20	3/4"	F NPTF	ANSI B1.20.3	NPTF 3/4" FEMALE	TNL 12 NPT F V	42	1.65	38	1.50	34	1.34
20	3/4"	F NPTF	ANSI B1.20.3	NPTF 3/4" FEMALE	TNL 12 NPT F	42	1.65	38	1.50	34	1.34

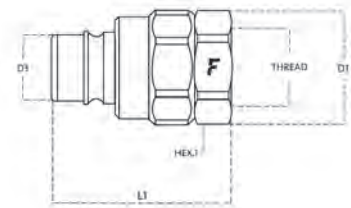

Size		Thread details			MALE								
mm	inch	Thread Type	Standard	Thread	Part Number	L (L1 + Thread)		D1		D3		HEX1	
						mm	inch	mm	inch	mm	inch	mm	inch
6.3	1/4"	F NPTF	ANSI B1.20.3	NPTF 1/4" FEMALE	TNL 04 NPT M	49	1.93	24	0.94	10.8	0.43	22	0.87
10	3/8"	F NPTF	ANSI B1.20.3	NPTF 3/8" FEMALE	TNL 06 NPT M	57	2.24	27	1.06	12.9	0.51	30	1.18
12.5	1/2"	F BSPP	ISO 1179-1	BSPP 1/2" FEMALE	TNL 08 GAS M	63	2.48	34	1.34	16	0.63	30	1.18
20	3/4"	F NPTF	ANSI B1.20.3	NPTF 3/4" FEMALE	TNL 12 NPT M	64	2.52	42	1.65	23.3	0.92	36	1.42

TNL Accessories and Spares



PVC dust protections

page 243

Aluminium dust protections

page 252

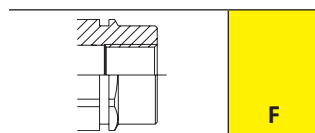



TNL brass

Standard couplings, US interchange, free flow, brass versions.

TNL series couplings are commonly used in US market as an alternative to standard series. Assembled without internal valves they have been designed to maximize flow. Fully interchangeable with TNV versions. Brass construction.



Applications



Pressure Drop

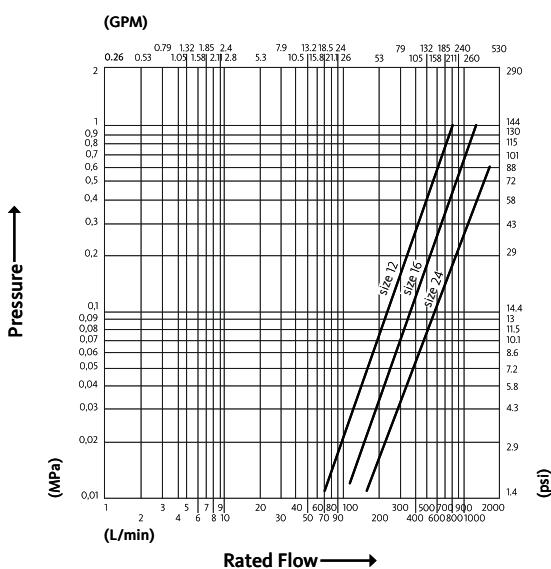

Test performed according to ISO 18869

Technical Specifications

dash	Size mm	inch	Working Pressure (MPa)	Flow Rate (l/min)	Spillage (ml)	Force to Connect (N)	Burst pressure (MPa)		
							Male	Female	Male + Female
12	20	3/4"	9.5	205	0	50			35
16	25	1"	7.5	280	0	100			30
24	37.5	1-1/2"	5.5	450	0	150			22

Material	Brass
Seals	NBR
Working temperatures	- 25 °C to + 125 °C
Surface treatment	
Series Interchange	MARKET

Valve Type	None
Connection	Sleeve Retraction
Disconnection	Sleeve Retraction
Connection Under Pressure	Not Allowed



TNL brass

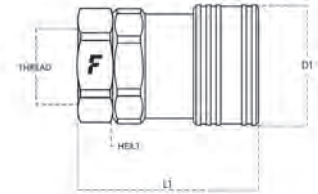

Size		Thread details			FEMALE						
mm	inch	Thread Type	Standard	Thread	Part Number	L (L1 + Thread)		D1		HEX1	
						mm	inch	mm	inch	mm	inch
12.5	1/2"	F NPTF	ISO 1173-1	BSPP 3/4" FEMALE	TNL 12 GAS F 5	42	1.65	42	1.65	34	1.34
25	1"	F NPTF	ANSI B1.20.3	NPTF 1" FEMALE	TNL 16 NPT F 5	51	2.01	52.5	2.07	48	1.89
37.5	1-1/2"	F BSPP	ISO 1179-1	BSPP 1-1/2" FEMALE	TNL 24 GAS F 5	91	3.58	70	2.76	65	2.56

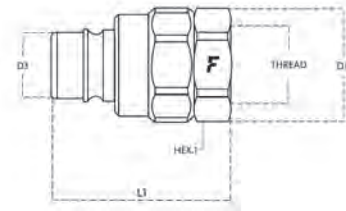

Size		Thread details			MALE								
mm	inch	Thread Type	Standard	Thread	Part Number	L (L1 + Thread)		D1		D3		HEX1	
						mm	inch	mm	inch	mm	inch	mm	inch
12.5	1/2"	F NPTF	ISO 1173-1	BSPP 3/4" FEMALE	TNL 12 GAS M 5	45.5	1.79	38	1.50	-	-	36	1.42
25	1"	F NPTF	ANSI B1.20.3	NPTF 1" FEMALE	TNL 16 NPT M 5	68	2.68	50.5	1.99	29.7	1.17	46	1.81
37.5	1-1/2"	F BSPP	ISO 1179-1	BSPP 1-1/2" FEMALE	TNL 24 GAS M 5	85	3.35	70	2.76	43.5	1.71	65	2.56

TNL brass Accessories and Spares



PVC dust protections

page 243

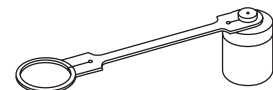
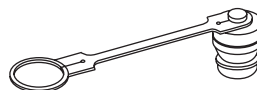

Aluminium dust protections

page 252

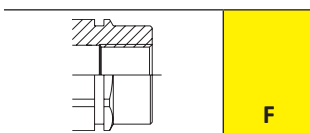

Agriculture



Couplings designed for agricultural application,
interchangeable according to ISO 7241 Part A.

ANV	page 49
AGRI	page 53
PV	page 55
PS	page 57
CPV	page 59
CPVN	page 63
CFPV	page 65
CNV	page 69
2NV	page 73
2NS	page 75
3CNV	page 77
3NV	page 79
3CPV	page 81

3CFHF	page 83
3CKHF	page 87
4PV	page 91
4CPV	page 93
4NV	page 95
4SRHF	page 99
4SKHF	page 103
6DNPV	page 107
VA	page 109
VF	page 111
5FPI	page 115
FPI	page 117
Couplings Accessories	page 242

ANV

Standard couplings for agriculture, ISO 7241 part A interchange.

Standard couplings for agriculture applications. Complete range of sizes from 1/4" to 2" (with BSP, NPT or SAE female threads available). ISO 7241 part A interchange.



Technical Specifications

dash	Size mm	inch	Working Pressure (MPa)	Flow Rate (l/min)	Spillage (ml)	Force to Connect (N)	Burst pressure (MPa)		
							Male	Female	Male + Female
04	6.3	1/4"	50	8	0.5	45	200	200	200
06	10	3/8"	30	30	1.1	80	120	140	160
08	12.5	1/2"	30	75	1.8	80	120	120	130
12	20	3/4"	30	180	8	150	120	120	120
16	25	1"	25	270	10	150	100	100	100
20	31.5	1-1/4"	25	330	20	170	100	100	100
24	37.5	1-1/2"	20	450	32	255	80	80	80
32	50	2"	15	900	85	440	60	60	60

Material	Steel
Seals	NBR
Working temperatures	- 25 °C to + 125 °C
Surface treatment	MATE 500 (CrIII)
Series Interchange	ISO 7241 part A

Applications



Pressure Drop

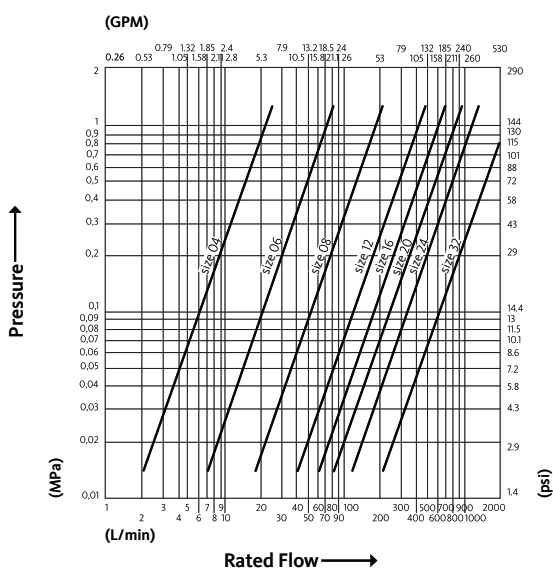

Test performed according to ISO 18869

Valve Type	Poppet
Connection	Sleeve Retraction
Disconnection	Sleeve Retraction
Connection Under Pressure	Not Allowed



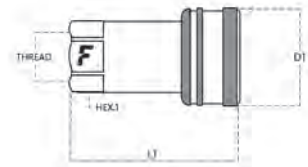

ANV

Size		Thread details			FEMALE						
mm	inch	Thread Type	Standard	Thread	Part Number	L (L1 + Thread)		D1		HEX1	
						mm	inch	mm	inch	mm	inch
6.3	1/4"	O/ METRIC	ISO 6149-1	M14x1.5 FEMALE ORB	ANV0/1415 F	47.7	1.88	25	0.98	19	0.75
6.3	1/4"	F NPTF	ANSI B1.20.3	NPTF 1/4" FEMALE	ANV 14 NPT F	48	1.89	25	0.98	19	0.75
6.3	1/4"	F JPT	UNI EN 10226-2	RC 1/4" FEMALE (JPT)	ANV 14 JPT F	47.2	1.86	25	0.98	19	0.75
6.3	1/4"	F BSPP	ISO 1179-1	BSPP 1/4" FEMALE	ANV 14 GAS F	47.2	1.86	25	0.98	19	0.75
6.3	1/4"	F BSPP	ISO 1179-1	BSPP 1/4" FEMALE	ANV 14 GAS F7	41.2	1.62	25.2	0.99	19	0.75
10	3/8"	F METRIC	ISO 9974-1	M18x1.5 FEMALE	ANV 1815 F	57	2.24	32	1.26	22	0.87
10	3/8"	F NPTF	ANSI B1.20.3	NPTF 3/8" FEMALE	ANV 38 NPT F	57	2.24	32	1.26	22	0.87
10	3/8"	F JPT	UNI EN 10226-2	RC 3/8" FEMALE (JPT)	ANV 38 JPT F	57.2	2.25	32	1.26	22	0.87
10	3/8"	F BSPP	ISO 1179-1	BSPP 3/8" FEMALE	ANV 38 GAS F	57	2.24	32	1.26	22	0.87
10	3/8"	F BSPP	ISO 1179-1	BSPP 3/8" FEMALE	ANV 38 GAS F7	57	2.24	32	1.26	22	0.87
20	3/4"	O/ SAE	ISO 11926-1	1-1/16"-12 UN FEMALE ORB	ANV 34-34SAE F	82.5	3.25	48	1.89	34	1.34
20	3/4"	F NPTF	ANSI B1.20.3	NPTF 3/4" FEMALE	ANV 34 NPT F	82.5	3.25	48	1.89	34	1.34
20	3/4"	F JPT	UNI EN 10226-2	RC 3/4" FEMALE (JPT)	ANV 34 JPT F	82.5	3.25	48	1.89	34	1.34
20	3/4"	F BSPP	ISO 1179-1	BSPP 3/4" FEMALE	ANV 34 GAS F	82.5	3.25	48	1.89	34	1.34
20	3/4"	F BSPP	ISO 1179-1	BSPP 3/4" FEMALE	ANV 34 GAS F7	82.6	3.25	48	1.89	34	1.34
25	1"	O/ SAE	ISO 11926-1	1-5/16"-12 UN FEMALE ORB	ANV 1-1 SAE F	100	3.94	56	2.2	41	1.61
25	1"	F JPT	UNI EN 10226-2	RC 1 FEMALE (JPT)	ANV 1 JPT F	100	3.94	56	2.2	41	1.61
25	1"	F NPTF	ANSI B1.20.3	NPTF 1" FEMALE	ANV 1 NPT F	100	3.94	56	2.2	41	1.61
25	1"	F BSPP	ISO 1179-1	BSPP 1" FEMALE	ANV 1 GAS F	100	3.94	56	2.2	41	1.61
31.5	1-1/4"	F NPTF	ANSI B1.20.3	NPTF 1-1/4" FEMALE	ANV114 NPT F	116	4.57	70	2.76	50	1.97
31.5	1-1/4"	F BSPP	ISO 1179-1	BSPP 1-1/4" FEMALE	ANV114 GAS F	116	4.57	70	2.76	50	1.97
37.5	1-1/2"	F BSPP	ISO 1179-1	BSPP 1-1/2" FEMALE	ANV112 GAS F	132.5	5.22	84	3.31	60	2.36
50	2"	F NPTF	ANSI B1.20.3	NPTF 2" FEMALE	ANV 2 NPT F	161	6.34	100	3.94	75	2.95
50	2"	F BSPP	ISO 1179-1	BSPP 2" FEMALE	ANV 2 GAS F	161	6.34	100	3.94	75	2.95

Part Numbers ending in 7 have Zn-Ni surface treatment for improved resistance against wear and corrosion.

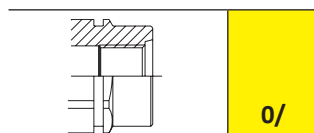
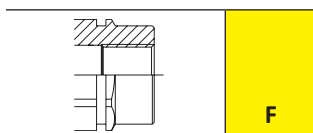

ANV

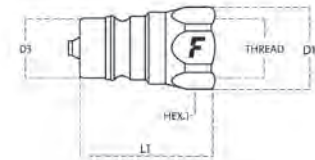

Size		Thread details			MALE									
mm	inch	Thread Type	Standard	Thread	Part Number	L (L1 + Thread)		D1		D3		HEX1		
						mm	inch	mm	inch	mm	inch	mm	inch	
6.3	1/4"	O/ METRIC	ISO 6149-1	M14x1.5 FEMALE ORB	ANV0/1415 M	39	1.54	21	0.83	11.8	0.46	19	0.75	
6.3	1/4"	O/ SAE	ISO 11926-1	9/16"-18 UNF FEMALE ORB	ANV 14-38SAE M	40.2	1.58	21	0.83	11.8	0.46	19	0.75	
6.3	1/4"	F NPTF	ANSI B1.20.3	NPTF 1/4" FEMALE	ANV 14 NPT M	38.6	1.52	21	0.83	11.8	0.46	19	0.75	
6.3	1/4"	F JPT	UNI EN 10226-2	RC 1/4" FEMALE (JPT)	ANV 14 JPT M	38.6	1.52	21	0.83	11.8	0.46	19	0.75	
6.3	1/4"	F BSPP	ISO 1179-1	BSPP 1/4" FEMALE	ANV 14 GAS M	38.6	1.52	21	0.83	11.8	0.46	19	0.75	
6.3	1/4"	F BSPP	ISO 1179-1	BSPP 1/4" FEMALE	ANV 14 GAS M7	38.6	1.52	11.8	0.46	11.8	0.46	19	0.75	
10	3/8"	F NPTF	ANSI B1.20.3	NPTF 3/8" FEMALE	ANV 38 NPT M	39	1.54	24	0.94	17.2	0.68	22	0.87	
10	3/8"	F METRIC	ISO 9974-1	M18x1.5 FEMALE	ANV 1815 M	39	1.54	24	0.94	17.2	0.68	22	0.87	
10	3/8"	F BSPP	ISO 1179-1	BSPP 3/8" FEMALE	ANV 38 GAS M	39	1.54	24	0.94	17.2	0.68	22	0.87	
10	3/8"	F BSPP	ISO 1179-1	BSPP 3/8" FEMALE	ANV 38 GAS M7	39	1.54	17.2	0.68	17.2	0.68	22	0.87	
10	3/8"	F JPT	UNI EN 10226-2	RC 3/8" FEMALE (JPT)	ANV 38 JPT M	39	1.54	24	0.94	17.2	0.68	22	0.87	
20	3/4"	O/ METRIC	ISO 6149-1	M26x1.5 FEMALE ORB	ANV0/2615 M	53	2.09	38	1.5	29	1.14	34	1.34	
20	3/4"	O/ SAE	ISO 11926-1	1-1/16"-12 UN FEMALE ORB	ANV 34-34SAE M	55	2.17	38	1.5	29	1.14	34	1.34	
20	3/4"	F NPTF	ANSI B1.20.3	NPTF 3/4" FEMALE	ANV 34 NPT M	55	2.17	38	1.5	29	1.14	34	1.34	
20	3/4"	F JPT	UNI EN 10226-2	RC 3/4" FEMALE (JPT)	ANV 34 JPT M	55	2.17	38	1.5	29	1.14	34	1.34	
20	3/4"	F BSPP	ISO 1179-1	BSPP 3/4" FEMALE	ANV 34 GAS M	55	2.17	38	1.5	29	1.14	34	1.34	
20	3/4"	F BSPP	ISO 1179-1	BSPP 3/4" FEMALE	ANV 34 GAS M7	55	2.17	29	1.14	29	1.14	34	1.34	
25	1"	F NPTF	ANSI B1.20.3	NPTF 1" FEMALE	ANV 1 NPT M	66	2.6	45	1.77	34.3	1.35	41	1.61	
25	1"	F JPT	UNI EN 10226-2	RC 1" FEMALE (JPT)	ANV 1 JPT M	66	2.6	45	1.77	34.3	1.35	41	1.61	
25	1"	F BSPP	ISO 1179-1	BSPP 1" FEMALE	ANV 1 GAS M	66	2.6	45	1.77	34.3	1.35	41	1.61	
31.5	1-1/4"	F NPTF	ANSI B1.20.3	NPTF 1-1/4" FEMALE	ANV114 NPT M	73	2.87	55.5	2.19	44.9	1.77	50	1.97	
31.5	1-1/4"	F BSPP	ISO 1179-1	BSPP 1-1/4" FEMALE	ANV114 GAS M	73	2.87	55.5	2.19	44.9	1.77	50	1.97	
37.5	1-1/2"	F BSPP	ISO 1179-1	BSPP 1-1/2" FEMALE	ANV112 GAS M	83	3.27	66	2.6	55	2.17	60	2.36	
50	2"	F NPTF	ANSI B1.20.3	NPTF 2" FEMALE	ANV 2 NPT M	100	3.94	85	3.35	65	2.56	75	2.95	
50	2"	F BSPP	ISO 1179-1	BSPP 2" FEMALE	ANV 2 GAS M	100	3.94	85	3.35	65	2.56	75	2.95	

Part Numbers ending in 7 have Zn-Ni surface treatment for improved resistance against wear and corrosion.

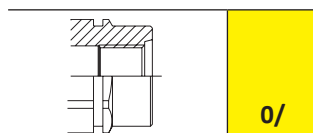
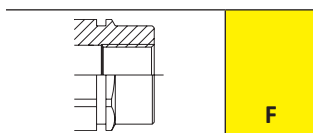

ANV Accessories and Spares



PVC dust protections

page 243



Seals Kits

page 262



AGRI

Male couplings for agriculture, ISO 7241 part A interchange.

The most popular male couplings for agriculture applications. Interchangeable according to ISO 7241 part A, size 1/2".



Applications



Pressure Drop

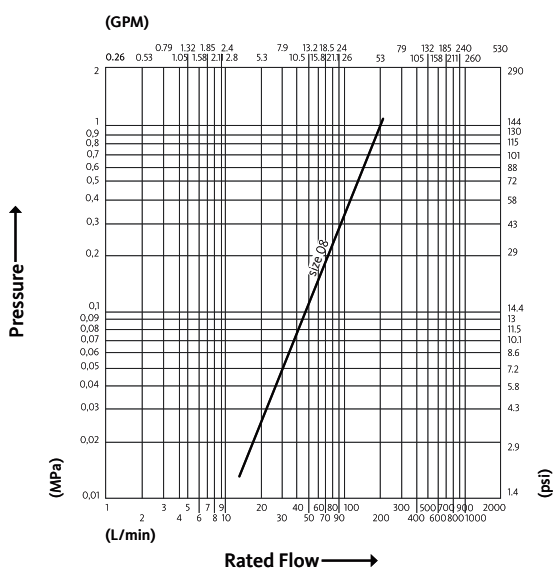

Test performed according to ISO 18869

Technical Specifications

dash	Size		Working Pressure (MPa)	Flow Rate (l/min)	Spillage (ml)	Force to Connect (N)	Burst pressure (MPa)		
	mm	inch					Male	Female	Male + Female
08	12.5	1/2"	25	75	1.8	80	100		130

Material	Steel
Seals	NBR
Working temperatures	- 25 °C to + 125 °C
Surface treatment	MATE 500 (CrIII)
Series Interchange	ISO 7241 part A

Valve Type	Poppet
Connection	
Disconnection	
Connection Under Pressure	Not Allowed



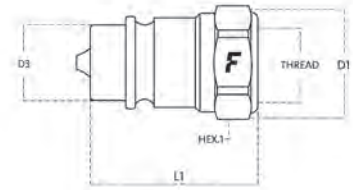

AGRI

Size		Thread details			MALE									
mm	inch	Thread Type	Standard	Thread	Part Number	L (L1 + Thread)		D1		D3		HEX1		
						mm	inch	mm	inch	mm	inch	mm	inch	
12.5	1/2"	F BSPP	ISO 1179-1	BSPP 1/2" FEMALE	AGRI 12 GAS M	44	1.73	30	1.18	20.5	0.81	27	1.06	
12.5	1/2"	F BSPP	ISO 1179-1	BSPP 1/2" FEMALE	AGRI 12 GAS M7	44	1.7	30	1.2	20.5	0.8	27	1.1	

Part Numbers ending in 7 have Zn-Ni surface treatment for improved resistance against wear and corrosion.

AGRI Accessories and Spares



PVC dust protections

page 243

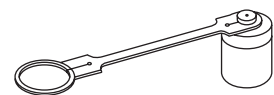

Aluminium dust protections

page 252

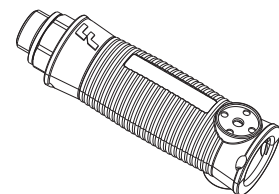

Line Identification System

page 260

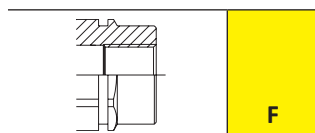

PV



Push-pull female couplings for agriculture, panel mounting, poppet valve.

Push-pull female couplings, designed for panel mounting installation. BSP and NPT female thread available. Breakaway function. ISO 7241 part A interchange.



Applications



Pressure Drop

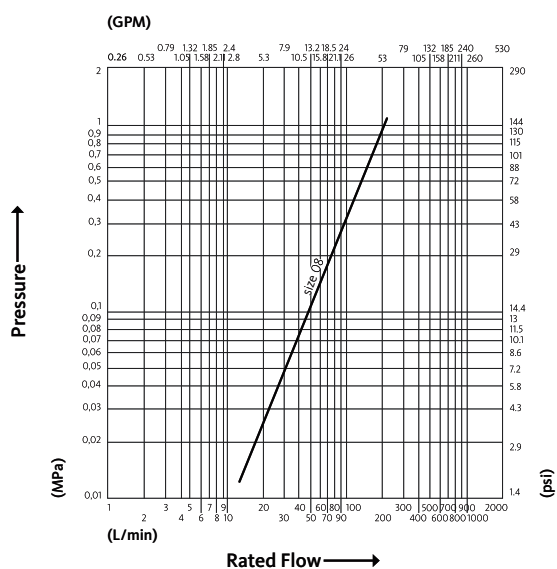

Test performed according to ISO 18869

Technical Specifications

dash	Size		Working Pressure (MPa)	Flow Rate (l/min)	Spillage (ml)	Force to Connect (N)	Burst pressure (MPa)		
	mm	inch					Male	Female	Male + Female
08	12.5	1/2"	25	75	1.8	110	110	148	

Material	Steel
Seals	NBR
Working temperatures	- 25 °C to + 125 °C
Surface treatment	MATE 500 (CrIII)
Series Interchange	ISO 7241 part A

Valve Type	Poppet
Connection	Push to Connect*
Disconnection	Pull to Disconnect*
Connection Under Pressure	Not Allowed



*If panel mounted through the sleeve. Otherwise sleeve retraction.

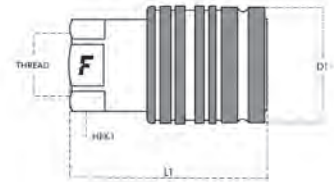

PV

Size		Thread details			FEMALE						
mm	inch	Thread Type	Standard	Thread	Part Number	L (L1 + Thread)		D1		HEX1	
						mm	inch	mm	inch	mm	inch
12.5	1/2"	F NPTF	ANSI B1.20.3	NPTF 1/2" FEMALE	PV 12 NPT F	66	2.6	38	1.5	27	1.06
12.5	1/2"	F BSPP	ISO 1179-1	BSPP 1/2" FEMALE	PV 12 GAS F	66	2.6	38	1.5	27	1.06
12.5	1/2"	F BSPP	ISO 1179-1	BSPP 1/2" FEMALE	PV 12 GAS F7	66	2.6	38	1.5	27	1.06

Part Numbers ending in 7 have Zn-Ni surface treatment for improved resistance against wear and corrosion.

PV Accessories and Spares



PVC dust protections

page 243

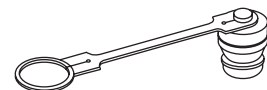

Aluminium dust protections

page 252



Seals Kits

page 262

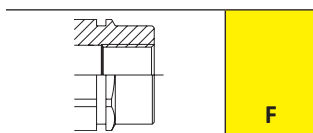



PS

Push-pull female couplings for agriculture, panel mounting, ball valve.

Push-pull female couplings, designed for panel mounting installation. BSP and NPT female thread available. Breakaway function. ISO 7241 part A interchangeable. Ball valve.



Applications



Pressure Drop

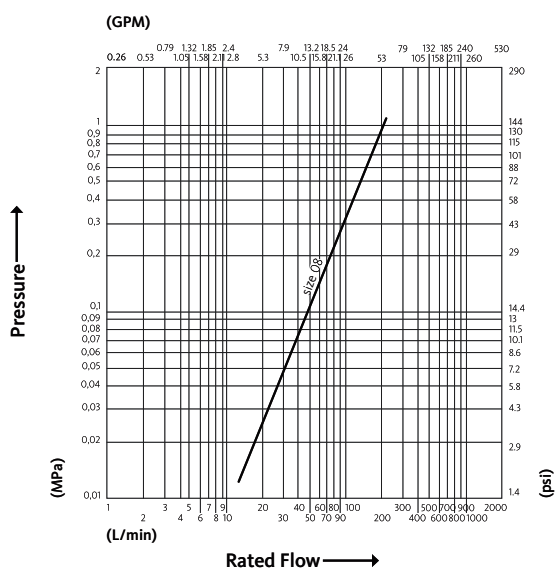

Test performed according to ISO 18869

Technical Specifications

dash	Size mm	inch	Working Pressure (MPa)	Flow Rate (l/min)	Spillage (ml)	Force to Connect (N)	Burst pressure (MPa)		
							Male	Female	Male + Female
08	12.5	1/2"	25	75	1.8	110	100	100	

Material	Steel
Seals	NBR
Working temperatures	- 25 °C to + 125 °C
Surface treatment	MATE 500 (CrIII)
Series Interchange	ISO 7241 part A

Valve Type	Ball
Connection	Push to Connect*
Disconnection	Pull to Disconnect*
Connection Under Pressure	Not Allowed



* If panel mounted through the sleeve. Otherwise sleeve retraction.

PS

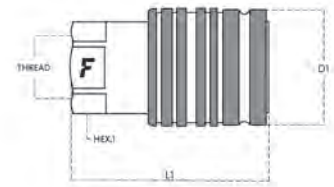

Size		Thread details			FEMALE						
mm	inch	Thread Type	Standard	Thread	Part Number	L (L1 + Thread)		D1		HEX1	
						mm	inch	mm	inch	mm	inch
12.5	1/2"	F BSPP	ISO 1179-1	BSPP 1/2" FEMALE	PS 12 GAS F	66	2.6	38	1.5	27	1.06

PS Accessories and Spares



PVC dust protections

page 243

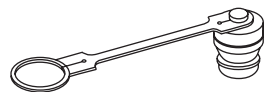

Aluminium dust protections

page 252



Seals Kits

page 262

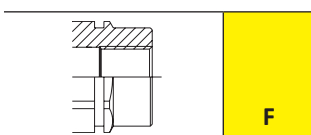

CPV



Push-pull female couplings for agriculture, panel mounting.

Push-pull female couplings, designed for panel mounting installation. A wide range of threaded adapters is available. Breakaway function. ISO 7241 part A interchange.



Applications



Pressure Drop

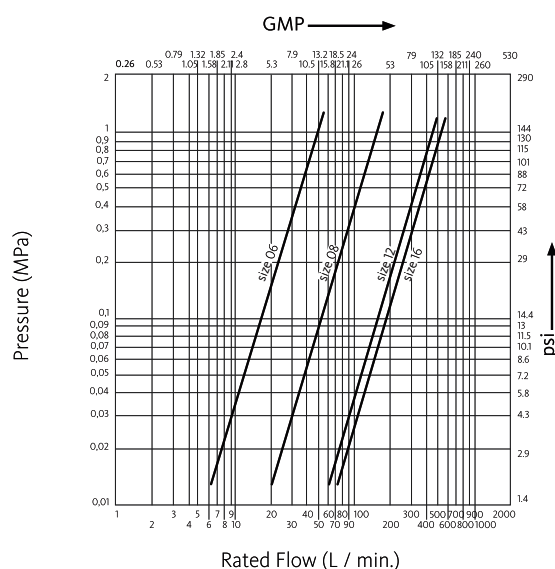

Test performed according to ISO 18869

Technical Specifications

dash	Size mm	inch	Working Pressure (MPa)	Flow Rate (l/min)	Spillage (ml)	Force to Connect (N)	Burst pressure (MPa)		
							Male	Female	Male + Female
06	10	3/8"	27	24	1.3	120	130	110	
08	12.5	1/2"	25	75	1.8	110	120	100	
12	20	3/4"	25	160	5	260	100	100	
16	25	1"	22	270	13	220	110	90	

Material	Steel
Seals	NBR
Working temperatures	- 25 °C to + 125 °C
Surface treatment	MATE 500 (CrIII)
Series Interchange	ISO 7241 part A

Valve Type	Poppet
Connection	Push to Connect*
Disconnection	Pull to Disconnect*
Connection Under Pressure	Not Allowed



* If panel mounted through the sleeve. Otherwise sleeve retraction.

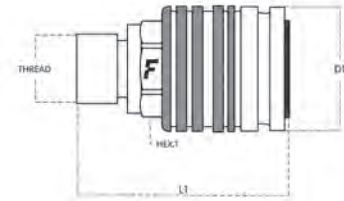

CPV

Size		Thread details			FEMALE							
mm	inch	Thread Type	Standard	Thread	Part Number	L (L1 + Thread)		D1		HEX1		
						mm	inch	mm	inch	mm	inch	
10	3/8"	07/ METRIC	ISO 8434-1-L	M14x1.5 MALE BULKHEAD SHORT 8L	CPV067/1415 F	76.7	3.02	33	1.3	24	0.94	
10	3/8"	02/ METRIC	ISO 8434-1-L	M16x1.5 MALE 10L	CPV062/1615 F	61.7	2.43	33	1.3	24	0.94	
10	3/8"	02/ METRIC	ISO 8434-1-L	M12x1.5 MALE 6L	CPV062/1215 F	60.7	2.39	33	1.3	24	0.94	
10	3/8"	01/ METRIC	ISO 6149-2	M16x1.5 MALE	CPV061/1615 F	62	2.44	33	1.3	24	0.94	
10	3/8"	F BSPP	ISO 1179-1	BSPP 3/8" FEMALE	CPV06 38 GAS F	64.5	2.54	33	1.3	24	0.94	
10	3/8"	F BSPP	ISO 1179-1	BSPP 1/2" FEMALE	CPV06 12 GAS F	65.5	2.58	33	1.3	24	0.94	
12.5	1/2"	27/ SAE	ISO 8434-3	1" - 14 UNS	CPV0827/58SAE F	69.3	2.73	38	1.5	30	1.18	
12.5	1/2"	11/ SAE	ISO 8434-3	1"-14 UNS MALE ORFS	CPV0811/58SAE F	66.8	2.63	38	1.5	27	1.06	
12.5	1/2"	07/ METRIC	ISO 8434-1-L	M26x1.5 MALE BULKHEAD SHORT 18L	CPV087/2615 F	90.8	3.57	40	1.57	30	1.18	
12.5	1/2"	07/ METRIC	ISO 8434-1-L	M16x1.5 MALE BULKHEAD SHORT 10L	CPV087/1615 F	78.8	3.1	38	1.5	27	1.06	
12.5	1/2"	06/ METRIC	ISO 8434-1-S	M20x1.5 MALE BULKHEAD 12S	CPV086/2015 F	86.3	3.4	40	1.57	27	1.06	
12.5	1/2"	05/ METRIC	ISO 8434-1-L	M22x1.5 MALE BULKHEAD 15L	CPV085/2215 F	86.3	3.4	38	1.5	27	1.06	
12.5	1/2"	05/ METRIC	ISO 8434-1-L	M16x1.5 MALE BULKHEAD 10L	CPV085/1615 F	86.3	3.4	38	1.5	27	1.06	
12.5	1/2"	04/ BSPP	ISO 8434-6	60° 3/8" BSPP MALE BULKHEAD	CPV084/38GAS F	87.8	3.46	38	1.5	27	1.06	
12.5	1/2"	04/ BSPP	ISO 8434-6	60° 1/2" BSPP MALE BULKHEAD	CPV084/12GAS F	87.8	3.46	38	1.5	27	1.06	
12.5	1/2"	03/ METRIC	ISO 8434-1-S	M24x1.5 MALE 16S	CPV083/2415 F	65.3	2.57	38	1.5	27	1.06	
12.5	1/2"	02/ METRIC	ISO 8434-1-L	M20x1.5 MALE 12S	CPV082/2015 F	63.3	2.49	38	1.5	27	1.06	
12.5	1/2"	02/ METRIC	ISO 8434-1-L	M14x1.5 MALE 8L	CPV082/1415 F	64.3	2.53	38	1.5	27	1.06	
12.5	1/2"	16/ METRIC	ISO 8434-6	60° 18x1.5 METRIC MALE	CPV0816/1815 F	65.3	2.57	38	1.5	27	1.06	
12.5	1/2"	16/ BSPP	ISO 8434-6	60° 1/2 BSPP MALE	CPV0816/12GAS F	65	2.56	38	1.5	27	1.06	
12.5	1/2"	14/ SAE	ISO 8434-2	3/4"-16 UN MALE BULKHEAD JIC	CPV0814/12SAE F	87.9	3.46	38	1.5	27	1.06	
12.5	1/2"	12/ SAE	ISO 8434-3	1"-14 UNS MALE BULKHEAD ORFS	CPV0812/58SAE F	96	3.78	38	1.5	34	1.34	
12.5	1/2"	12/ SAE	ISO 8434-3	13/16"-16 UN MALE BULKHEAD ORFS	CPV0812/12SAE F	85.8	3.38	38	1.5	27	1.06	
12.5	1/2"	11/ SAE	ISO 8434-3	13/16"-16 UN MALE ORFS	CPV0811/12SAE F	64.1	2.52	38	1.5	27	1.06	
12.5	1/2"	01/ METRIC	ISO 6149-2	M22x1.5 MALE	CPV081/2215 F	66.3	2.61	38	1.5	27	1.06	
12.5	1/2"	01/ SAE	ISO 11926-3	3/4"-16 UNF MALE	CPV081/12SAE F	62.4	2.46	38	1.5	27	1.06	
12.5	1/2"	0/ SAE	ISO 11926-1	7/8"-14 UNF FEMALE ORB	CPV080/58SAE F	62.3	2.45	38	1.5	27	1.06	
12.5	1/2"	0/ BSPP	BS 5380	3/8 BSP FEMALE ORB	CPV080/38GAS F	62.3	2.45	38	1.5	27	1.06	
12.5	1/2"	0/ METRIC	ISO 6149-1	M18x1.5 FEMALE ORB	CPV080/1815 F	62.3	2.45	38	1.5	27	1.06	
12.5	1/2"	0/ SAE	ISO 11926-1	3/4"-16 UNF FEMALE ORB	CPV080/12SAE F	66.3	2.61	38	1.5	27	1.06	
12.5	1/2"	F BSPP	ISO 1179-1	BSPP 3/8" FEMALE	CPV08 38 GAS F	62.3	2.45	38	1.18	27	1.06	
12.5	1/2"	F METRIC	ISO 9974-1	M22x1.5 FEMALE	CPV08 2215 F	66	2.6	38	1.5	27	1.06	
12.5	1/2"	03/ METRIC	ISO 8434-1-S	M20x1.5 MALE 12S	CPV083/2015 F	62.3	2.45	38	1.5	27	1.06	
12.5	1/2"	07/ METRIC	ISO 8434-1-L	M22x1.5 MALE BULKHEAD SHORT 15L	CPV087/2215 F	77.3	3.04	38	1.5	27	1.06	
12.5	1/2"	05/ METRIC	ISO 8434-1-L	M18x1.5 MALE BULKHEAD 12L	CPV085/1815 F	86.3	3.4	38	1.5	27	1.06	
12.5	1/2"	0/ BSPP	BS 5380	1/2 BSP FEMALE ORB	CPV080/12GAS F	66.3	2.61	38	1.5	27	1.06	
12.5	1/2"	0/ METRIC	ISO 6149-1	M22x1.5 FEMALE ORB	CPV080/2215 F	66.3	2.61	38	1.5	27	1.06	
12.5	1/2"	07/ METRIC	ISO 8434-1-L	M18x1.5 MALE BULKHEAD SHORT 12L	CPV087/1815 F	77.3	3.04	38	1.5	27	1.06	
12.5	1/2"	02/ METRIC	ISO 8434-1-L	M26x1.5 MALE 18L	CPV082/2615 F	62.3	2.45	38	1.5	27	1.06	
12.5	1/2"	02/ METRIC	ISO 8434-1-L	M22x1.5 MALE 15L	CPV082/2215 F	62.3	2.45	38	1.5	27	1.06	
12.5	1/2"	02/ METRIC	ISO 8434-1-L	M16x1.5 MALE 10L	CPV082/1615 F	63.8	2.51	38	1.5	27	1.06	
12.5	1/2"	02/ METRIC	ISO 8434-1-L	M18x1.5 MALE 12L	CPV082/1815 F	62.3	2.45	38	1.5	27	1.06	
12.5	1/2"	02/ METRIC	ISO 8434-1-L	M22x1.5 MALE 15L	CPV082/2215 F7	63.3	2.49	38	1.5	27	1.06	
12.5	1/2"	02/ METRIC	ISO 8434-1-L	M18x1.5 MALE 12L	CPV082/1815 F7	62.3	2.45	38	1.5	27	1.06	
20	3/4"	F BSPP	ISO 1179-1	BSPP 3/4" FEMALE	CPV12 34GAS F	95.3	3.75	46	1.8	34	1.34	
25	1"	05/ METRIC	ISO 8434-1-L	M36x2 MALE BULKHEAD 28L	CPV165/362 F	113.8	4.48	54	2.13	42	1.65	
25	1"	05/ METRIC	ISO 8434-1-L	M30x2 MALE BULKHEAD 22L	CPV165/302 F	116.8	4.6	54	2.13	41	1.61	
25	1"	05/ METRIC	ISO 8434-1-L	M26x1.5 MALE BULKHEAD 18L	CPV165/2615 F	124.3	4.89	54	2.13	38	1.5	
25	1"	03/ METRIC	ISO 8434-1-S	M30x2 MALE 20S	CPV163/302 F	100.3	3.95	54	2.13	38	1.5	

CPV

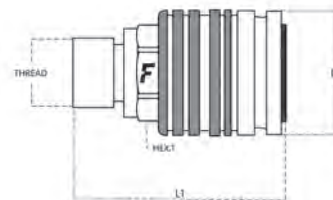

Size		Thread details			FEMALE						
mm	inch	Thread Type	Standard	Thread	Part Number	L (L1 + Thread)		D1		HEX1	
						mm	inch	mm	inch	mm	inch
25	1"	O2/ METRIC	ISO 8434-1-L	M30x2 MALE 22L	CPV162/302 F	96.8	3.81	54	2.13	38	1.5
25	1"	O2/ METRIC	ISO 8434-1-L	M26x1.5 MALE 18L	CPV162/2615 F	96.3	3.79	54	2.13	38	1.5
25	1"	O/ BSPP	BS 5380	3/4 BSP FEMALE ORB	CPV160/34GAS F	97.3	3.83	54	2.13	38	1.5
25	1"	O/ BSPP	BS 5380	1 BSP FEMALE ORB	CPV160/1GAS F	100.3	3.95	54	2.13	42	1.65
25	1"	F BSPP	ISO 1179-1	BSPP 3/4" FEMALE	CPV16 34GAS F	97.3	3.83	54	2.13	38	1.5
25	1"	O/ SAE	ISO 11926-1	1-5/16"-12 UN FEMALE ORB	CPV16 1SAE F	100.3	3.95	54	2.13	42	1.65
25	1"	F BSPP	ISO 1179-1	BSPP 1" FEMALE	CPV16 1GAS F	102.3	4.03	54	2.13	42	1.65

Part Numbers ending in 7 have Zn-Ni surface treatment for improved resistance against wear and corrosion.

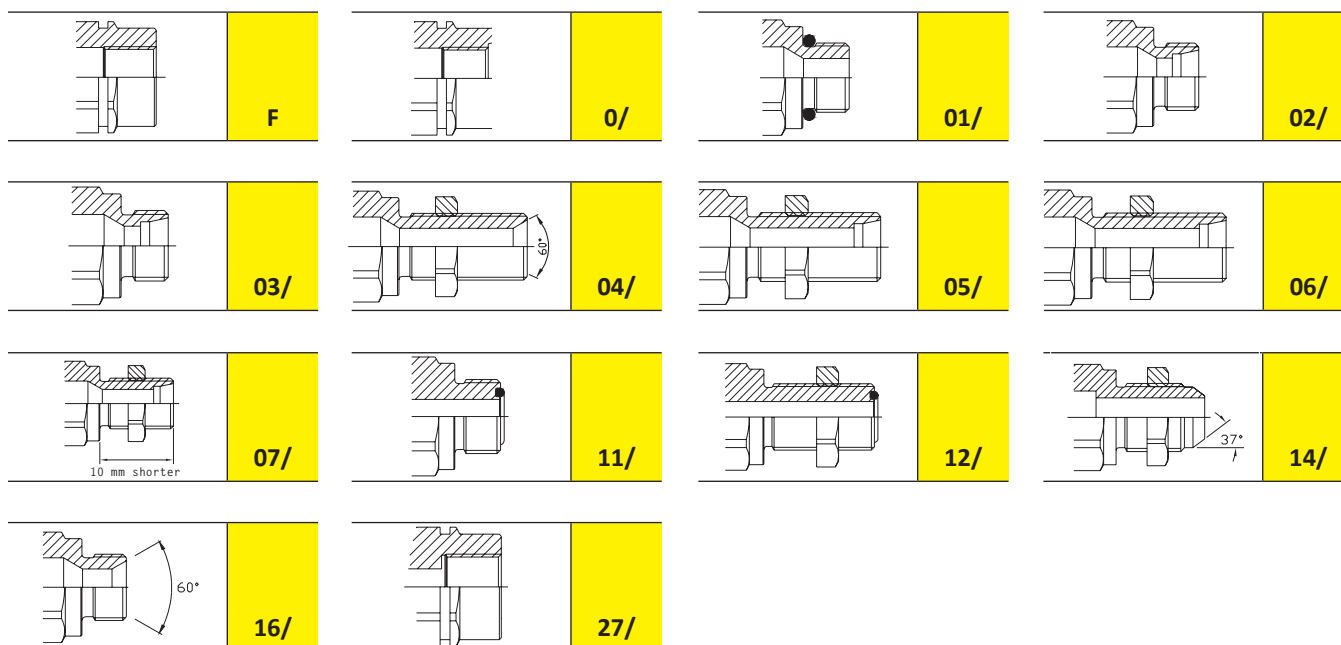

CPV Accessories and Spares



PVC dust protections

page 243

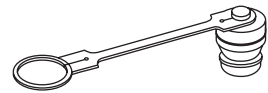

Aluminium dust protections

page 252



Seals Kits

page 262

CPVN



Push-pull female couplings for agriculture, panel mounting.

Push-pull couplings, designed for panel mounting installation. Breakaway function. Male part: NV 3/8".



Applications



Pressure Drop

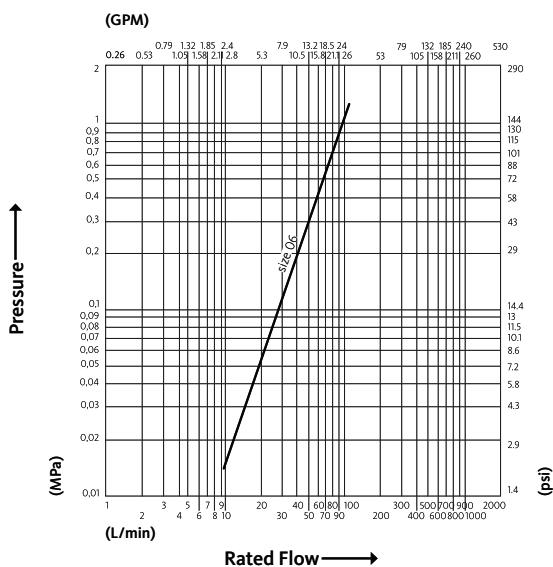

Test performed according to ISO 18869

Technical Specifications

dash	Size mm	inch	Working Pressure (MPa)	Flow Rate (l/min)	Spillage (ml)	Force to Connect (N)	Burst pressure (MPa)		
							Male	Female	Male + Female
06	10	3/8"	30	40	1.3	120	120	120	

Material	Steel
Seals	NBR
Working temperatures	- 25 °C to + 125 °C
Surface treatment	MATE 500 (CrIII)
Series Interchange	MARKET

Valve Type	Poppet
Connection	Push to Connect
Disconnection	Pull to Disconnect
Connection Under Pressure	Not Allowed



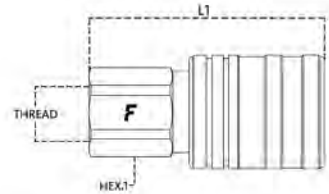

CPVN

Size		Thread details			FEMALE						
mm	inch	Thread Type	Standard	Thread	Part Number	L (L1 + Thread)		D1		HEX1	
						mm	inch	mm	inch	mm	inch
10	3/8"	F NPTF	ANSI B1.20.3	NPTF 3/8" FEMALE	CPVN0638NPT FSF	68.8	2.71	33.5	1.32	24	0.94

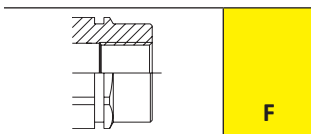

CFPV



Push-pull female couplings for agriculture.

Push-pull female couplings with breakaway function. Not suitable for connection under pressure. Commonly used for Power Beyond applications. ISO 7241 part A interchange.



Applications



Pressure Drop

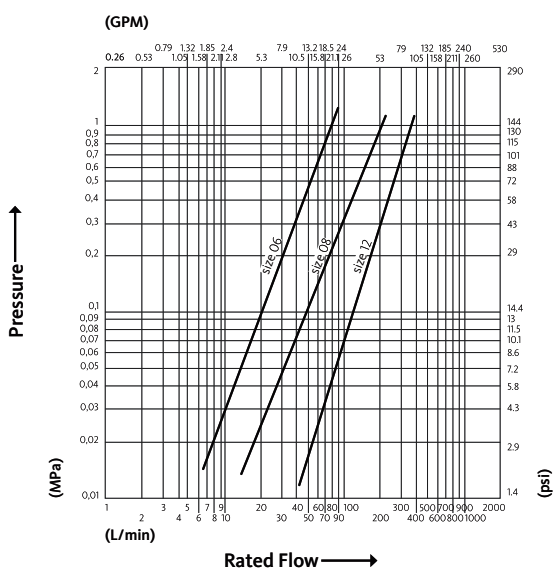

Test performed according to ISO 18869

Technical Specifications

dash	Size		Working Pressure (MPa)	Flow Rate (l/min)	Spillage (ml)	Force to Connect (N)	Burst pressure (MPa)		
	mm	inch					Male	Female	Male + Female
06	10	3/8"	30	30	1.3	250	120	140	
08	12.5	1/2"	25	70	2	240	100	100	
12	20	3/4"	25	140	5	310	100	110	

Material	Steel
Seals	NBR
Working temperatures	- 25 °C to + 125 °C
Surface treatment	MATE 500 (CrIII)
Series Interchange	ISO 7241 part A

Valve Type	Poppet
Connection	Push to Connect
Disconnection	Pull to Disconnect
Connection Under Pressure	Not Allowed



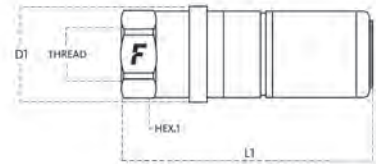

CFPV

Size		Thread details			FEMALE						
mm	inch	Thread Type	Standard	Thread	Part Number	L (L1 + Thread)		D1		HEX1	
						mm	inch	mm	inch	mm	inch
10	3/8"	01/ METRIC	ISO 6149-2	M14x1.5 MALE	CFPV061/1415 F	126.5	4.98	31	1.22	28	1.1
10	3/8"	07/ METRIC	ISO 8434-1-L	M14x1.5 MALE BULKHEAD SHORT 8L	CFPV067/1415 F	98.3	3.87	31	1.22	27	1.06
10	3/8"	01/ METRIC	ISO 6149-2	M14x1.5 MALE	CFPV061/1415 F	89.8	3.54	31	1.22	27	1.06
10	3/8"	01/ METRIC	ISO 6149-2	M12x1.5 MALE	CFPV061/1215 F	89.8	3.54	31	1.22	27	1.06
10	3/8"	F BSPP	ISO 1179-1	BSPP 1/4" FEMALE	CFPV06 14GAS F	85	3.35	31	1.22	27	1.06
12.5	1/2"	0/ METRIC	ISO 6149-1	M22x1.5 FEMALE ORB	CFPV080/2215 F	110.2	1.34	42	1.65	34	4.34
12.5	1/2"	01/ METRIC	ISO 6149-2	M22x1.5 MALE	CFPV081/2215 F	110.7	4.36	42	1.65	32	1.26
20	3/4"	07/ METRIC	ISO 8434-1-L	M36x2 MALE BULKHEAD SHORT 28L	CFPV127/362 F	133.5	5.26	48	1.89	42	1.65
20	3/4"	06/ METRIC	ISO 8434-1-S	M42x2 MALE BULKHEAD 30S	CFPV126/422 F	151.5	5.96	54	2.13	50	1.97
20	3/4"	06/ METRIC	ISO 8434-1-S	M36x2 MALE BULKHEAD 25S	CFPV126/362 F	138.5	5.45	48	1.89	42	1.65
20	3/4"	06/ METRIC	ISO 8434-1-S	M30x2 MALE BULKHEAD 20S	CFPV126/302 F	144.5	5.69	48	1.89	42	1.65
20	3/4"	05/ METRIC	ISO 8434-1-L	M36x2 MALE BULKHEAD 28L	CFPV125/362 F	143.6	5.65	48	1.89	42	1.65
20	3/4"	05/ METRIC	ISO 8434-1-L	M30x2 MALE BULKHEAD 22L	CFPV125/302 F	134.5	5.3	48	1.89	42	1.65
20	3/4"	05/ METRIC	ISO 8434-1-L	M26x1.5 MALE BULKHEAD 18L	CFPV125/2615 F	153.5	6.04	48	1.89	42	1.65
20	3/4"	12/ SAE	ISO 8434-3	1 3/16" - 12 UN MALE BULKHEAD ORFS	CFPV1212/345 F	140.5	5.53	48	1.89	42	1.65
20	3/4"	12/ SAE	ISO 8434-3	1 7/16" - 12 UN MALE BULKHEAD ORFS	CFPV1212/15 F	142.5	5.61	48	1.89	42	1.65
20	3/4"	01/ SAE	ISO 11926-3	1-1/16"-12 UN MALE	CFPV121/345 F	115.6	4.55	48	1.89	42	1.65
20	3/4"	01/ METRIC	ISO 6149-2	M30x2 MALE	CFPV121/302 F	121.5	4.78	48	1.89	42	1.65
20	3/4"	01/ METRIC	ISO 6149-2	M27x2 MALE	CFPV121/272 F	121.5	4.78	48	1.89	42	1.65
20	3/4"	21/ METRIC	ISO 9974-2	M22x1.5 MALE	CFPV121/2215 F	118	4.65	48	1.89	42	1.65
20	3/4"	0/ METRIC	ISO 6149-1	M27x2 FEMALE ORB	CFPV120/272 F	117.5	4.63	48	1.89	42	1.65
20	3/4"	F BSPP	ISO 1179-1	BSPP 3/4" FEMALE	CFPV12 34GAS F	116.5	4.59	48	1.89	42	1.65

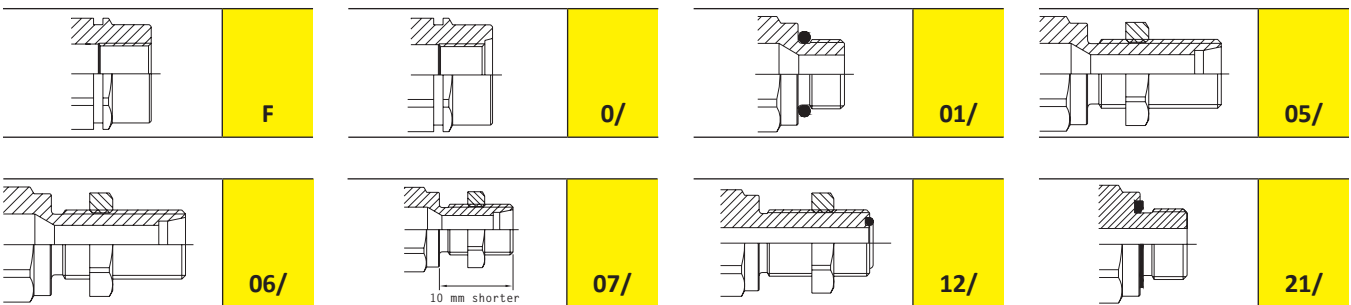

CFPV Accessories and Spares



PVC dust protections

page 243



Acetal Resin dust protections

page 250

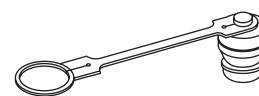

Aluminium dust protections

page 252



Seals Kits

page 262

CNV



Male couplings for agriculture, suitable for CPV female parts, ISO 7241 part A interchange.

Standard male couplings for agriculture applications. Wide range of male threads available. ISO 7241 part A interchange.



Applications



Pressure Drop

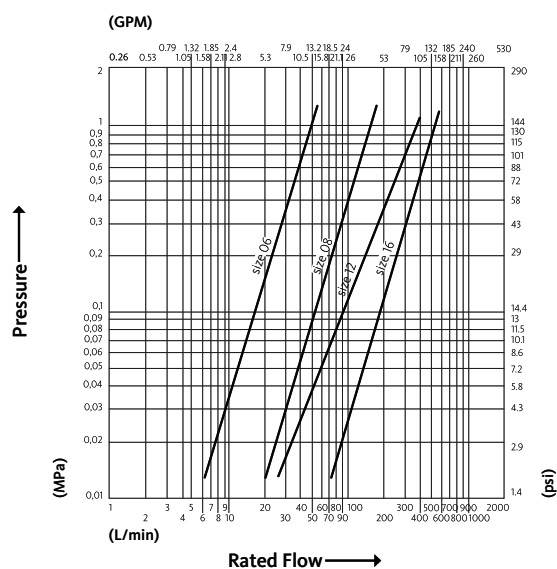

Test performed according to ISO 18869

Technical Specifications

dash	Size		Working Pressure (MPa)	Flow Rate (l/min)	Spillage (ml)	Force to Connect (N)	Burst pressure (MPa)		
	mm	inch					Male	Female	Male + Female
06	10	3/8"	27	24	1.3	120	115	110	
08	12.5	1/2"	25	75	1.8	110	100	100	
12	20	3/4"	25	160	8	250	100	100	
16	25	1"	22	270	13	220	100	90	

Material	Steel
Seals	NBR
Working temperatures	- 25 °C to + 125 °C
Surface treatment	MATE 500 (CrIII)
Series Interchange	ISO 7241 part A

Valve Type	Poppet
Connection	Sleeve Retraction
Disconnection	Sleeve Retraction
Connection Under Pressure	Not Allowed



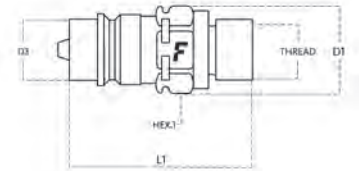

Size		Thread details			MALE									
mm	inch	Thread Type	Standard	Thread	Part Number	L (L1 + Thread)		D1		D3		HEX1		
						mm	inch	mm	inch	mm	inch	mm	inch	
10	3/8"	07/ METRIC	ISO 8434-1-L	M18x1.5 MALE BULKHEAD SHORT 12L	CNV067/1815 M	69.2	2.72	27	1.06	17.2	0.68	24	0.94	
10	3/8"	02/ METRIC	ISO 8434-1-L	M18x1.5 MALE 12L	CNV062/1815 M	54.2	2.13	26	1.02	17.2	0.68	24	0.94	
10	3/8"	02/ METRIC	ISO 8434-1-L	M16x1.5 MALE 10L	CNV062/1615 M	54.2	2.13	26	1.02	17.2	0.68	24	0.94	
10	3/8"	01/ SAE	ISO 11926-3	3/4"-16 UNF MALE	CNV061/12SAE M	53	2.09	26	1.02	17.2	0.68	24	0.94	
10	3/8"	0/ METRIC	ISO 6149-1	M14x1.5 FEMALE ORB	CNV060/1415 M	53	2.09	26	1.02	17.2	0.68	24	0.94	
12.5	1/2"	08/ METRIC	ISO 8434-1-S	M22x1.5 MALE BULKHEAD SHORT	CNV088/2215 M	72	2.83	30	1.18	20.5	0.81	27	1.06	
12.5	1/2"	07/ METRIC	ISO 8434-1-L	M18x1.5 MALE BULKHEAD SHORT 12L	CNV087/1815 M	72	2.83	30	1.18	20.5	0.81	27	1.06	
12.5	1/2"	07/ METRIC	ISO 8434-1-L	M16x1.5 MALE BULKHEAD SHORT 10L	CNV087/1615 M	73.5	2.89	30	1.18	20.5	0.81	27	1.06	
12.5	1/2"	06/ METRIC	ISO 8434-1-S	M20x1.5 MALE BULKHEAD 12S	CNV086/2015 M	81	3.19	30	1.18	20.5	0.81	27	1.06	
12.5	1/2"	05/ METRIC	ISO 8434-1-L	M22x1.5 MALE BULKHEAD 15L	CNV085/2215 M	81	3.19	30	1.18	20.5	0.81	27	1.06	
12.5	1/2"	05/ METRIC	ISO 8434-1-L	M16x1.5 MALE BULKHEAD 10L	CNV085/1615 M	81	3.19	30	1.18	20.5	0.81	27	1.06	
12.5	1/2"	04/ BSPP	ISO 8434-6	60° 1/2" BSPP MALE BULKHEAD	CNV084/12GAS M	82.5	3.25	30	1.18	20.5	0.81	27	1.06	
12.5	1/2"	03/ METRIC	ISO 8434-1-S	M24x1.5 MALE 16S	CNV083/2415 M	60	2.36	30	1.18	20.5	0.81	27	1.06	
12.5	1/2"	03/ METRIC	ISO 8434-1-S	M20x1.5 MALE 12S	CNV083/2015 M	58	2.28	30	1.18	20.5	0.81	27	1.06	
12.5	1/2"	27/ SAE	ISO 8434-3	1" - 14 UNS	CNV0827/58SAE M	64	2.52	33	1.3	20.5	0.81	30	1.18	
12.5	1/2"	22/ BSPP	DIN 3852-2-A	1/2 BSPP MALE	CNV0822/12GAS M	60	2.36	30	1.18	20.5	0.81	27	1.06	
12.5	1/2"	02/ METRIC	ISO 8434-1-L	M26x1.5 MALE 18L	CNV082/2615 M	58	2.28	30	1.18	20.5	0.81	27	1.06	
12.5	1/2"	02/ METRIC	ISO 8434-1-L	M14x1.5 MALE 8L	CNV082/1415 M	59	2.32	30	1.18	20.5	0.81	27	1.06	
12.5	1/2"	02/ METRIC	ISO 8434-1-L	M18x1.5 MALE 12L	CNV082/1815 M7	57	2.24	30	1.18	20.5	0.81	27	1.06	
12.5	1/2"	02/ METRIC	ISO 8434-1-L	M22x1.5 MALE 15L	CNV082/2215 M7	57	2.24	30	1.18	20.5	0.81	27	1.06	
12.5	1/2"	16/ BSPP	ISO 8434-6	60° 1/2 BSPP MALE	CNV0816/12GAS M	60	2.36	30	1.18	20.5	0.81	27	1.06	
12.5	1/2"	14/ SAE	ISO 8434-2	3/4"-16 UN MALE BULKHEAD JIC	CNV0814/12SAE M	83	3.27	30	1.18	20.5	0.81	27	1.06	
12.5	1/2"	12/ SAE	ISO 8434-3	13/16"-16 UN MALE BULKHEAD ORFS	CNV0812/12SAE M	80.5	3.17	30	1.18	20.5	0.81	27	1.06	
12.5	1/2"	01/ METRIC	ISO 6149-2	M27x2 MALE	CNV081/272 M	67	2.64	35	1.38	20.5	0.81	32	1.26	
12.5	1/2"	21/ METRIC	ISO 9974-2	M22x1.5 MALE	CNV081/2215 M	61	2.4	30	1.18	20.5	0.81	27	1.06	
12.5	1/2"	01/ METRIC	ISO 6149-2	M18x1.5 MALE	CNV081/1815 M	60	2.36	30	1.18	20.5	0.81	27	1.06	
12.5	1/2"	01/ SAE	ISO 11926-3	3/4"-16 UNF MALE	CNV081/12SAE M	57	2.24	30	1.18	20.5	0.81	27	1.06	
12.5	1/2"	0/ BSPP	BS 5380	3/8 BSP FEMALE ORB	CNV080/38GAS M	57	2.24	30	1.18	20.5	0.81	27	1.06	
12.5	1/2"	0/ METRIC	ISO 6149-1	M22x1.5 FEMALE ORB	CNV080/2215 M	61	2.4	30	1.18	20.5	0.81	27	1.06	
12.5	1/2"	0/ METRIC	ISO 6149-1	M20x1.5 FEMALE ORB	CNV080/2015 M	60	2.36	30	1.18	20.5	0.81	27	1.06	
12.5	1/2"	0/ METRIC	ISO 6149-1	M18x1.5 FEMALE ORB	CNV080/1815 M	57	2.24	30	1.18	20.5	0.81	27	1.06	
12.5	1/2"	0/ METRIC	ISO 6149-1	M16x1.5 FEMALE ORB	CNV080/1615 M	57	2.24	30	1.18	20.5	0.81	27	1.06	
12.5	1/2"	F BSPP	ISO 1179-1	BSPP 3/8" FEMALE	CNV08 38 GAS M	57	2.24	30	1.18	20.5	0.81	27	1.06	
12.5	1/2"	05/ METRIC	ISO 8434-1-L	M18x1.5 MALE BULKHEAD 12L	CNV085/1815 M	78	3.07	30	1.18	20.5	0.81	27	1.06	
12.5	1/2"	07/ METRIC	ISO 8434-1-L	M22x1.5 MALE BULKHEAD SHORT 15L	CNV087/2215 M	72	2.83	30	1.18	20.5	0.81	27	1.06	
12.5	1/2"	36/ BSP	ISO 8434-6	60° 1/2 BSP MALE	CNV0836/12GAS M	89	3.5	30	1.18	20.5	0.81	27	1.06	
12.5	1/2"	16/ BSPP	ISO 8434-6	60° 3/8 BSPP MALE	CNV0816/38GAS M	59.5	2.34	30	1.18	20.5	0.81	27	1.06	
12.5	1/2"	02/ METRIC	ISO 8434-1-L	M16x1.5 MALE 10L	CNV082/1615 M	58.5	2.3	30	1.18	20.5	0.81	27	1.06	
12.5	1/2"	02/ METRIC	ISO 8434-1-L	M22x1.5 MALE 15L	CNV082/2215 M	58	2.28	30	1.18	20.5	0.81	27	1.06	
12.5	1/2"	02/ METRIC	ISO 8434-1-L	M18x1.5 MALE 12L	CNV082/1815 M	57	2.24	30	1.18	20.5	0.81	27	1.06	
20	3/4"	07/ METRIC	ISO 8434-1-L	M36x2 MALE BULKHEAD SHORT 28L	CNV127/362 M	100.2	3.94	51.5	2.03	29	1.14	41	1.61	

CNV

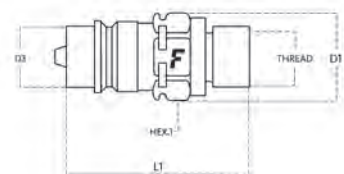

Size		Thread details			MALE									
mm	inch	Thread Type	Standard	Thread	Part Number	L (L1 + Thread)		D1		D3		HEX1		
						mm	inch	mm	inch	mm	inch	mm	inch	
20	3/4"	05/ METRIC	ISO 8434-1-L	M45x2 MALE BULKHEAD 35L	CNV125/452 M	114.2	4.5	62	2.44	29	1.14	55	2.17	
20	3/4"	05/ METRIC	ISO 8434-1-L	M36x2 MALE BULKHEAD 28L	CNV125/362 M	109	4.29	51.5	2.03	29	1.14	41	1.61	
20	3/4"	05/ METRIC	ISO 8434-1-L	M30x2 MALE BULKHEAD 22L	CNV125/302 M	101.2	3.98	46	1.81	29	1.14	36	1.42	
20	3/4"	03/ METRIC	ISO 8434-1-S	M30x2 MALE 20S	CNV123/302 M	83.2	3.28	38	1.5	29	1.14	34	1.34	
20	3/4"	12/ SAE	ISO 8434-3	1 3/16" - 12 UN MALE BULKHEAD ORFS	CNV1212/34SAE M	106.7	4.2	42	1.65	29	1.14	36	1.42	
20	3/4"	12/ SAE	ISO 8434-3	1 7/16" - 12 UN MALE BULKHEAD ORFS	CNV1212/1SAE M	109.2	4.3	50	1.97	29	1.14	42	1.65	
20	3/4"	01/ METRIC	ISO 6149-2	M27x2 MALE	CNV121/272 M	86.5	3.41	35	1.38	29	1.14	32	1.26	
20	3/4"	01/ METRIC	ISO 6149-2	M22x1.5 MALE	CNV121/2215 M	86.5	3.41	35	1.38	29	1.14	32	1.26	
20	3/4"	0/ METRIC	ISO 6149-1	M27x2 FEMALE ORB	CNV120/272 M	85.5	3.37	38	1.5	29	1.14	34	1.34	
25	1"	03/ METRIC	ISO 8434-1-S	M30x2 MALE 20S	CNV163/302 M	75	2.95	42.5	1.67	34.3	1.35	38	1.5	
25	1"	02/ METRIC	ISO 8434-1-L	M36x2 MALE 28L	CNV162/362 M	70	2.76	42.5	1.67	34.3	1.35	38	1.5	
25	1"	02/ METRIC	ISO 8434-1-L	M30x2 MALE 22L	CNV162/302 M	71.5	2.81	42.5	1.67	34.3	1.35	38	1.5	
25	1"	0/ BSPP	BS 5380	3/4 BSP FEMALE ORB	CNV160/34GAS M	72	2.83	42.5	1.67	34.3	1.35	38	1.5	
25	1"	0/ BSPP	BS 5380	1 BSP FEMALE ORB	CNV160/1GAS M	75	2.95	46	1.81	34.3	1.35	42	1.65	
25	1"	F BSPP	ISO 1179-1	BSPP 1" FEMALE	CNV16 34GAS M	72	2.83	42.5	1.67	34.3	1.35	38	1.5	
25	1"	F BSPP	ISO 1179-1	BSPP 1" FEMALE	CNV16 1GAS M	77	3.03	46	1.81	34.3	1.35	42	1.65	

Part Numbers ending in 7 have Zn-Ni surface treatment for improved resistance against wear and corrosion.

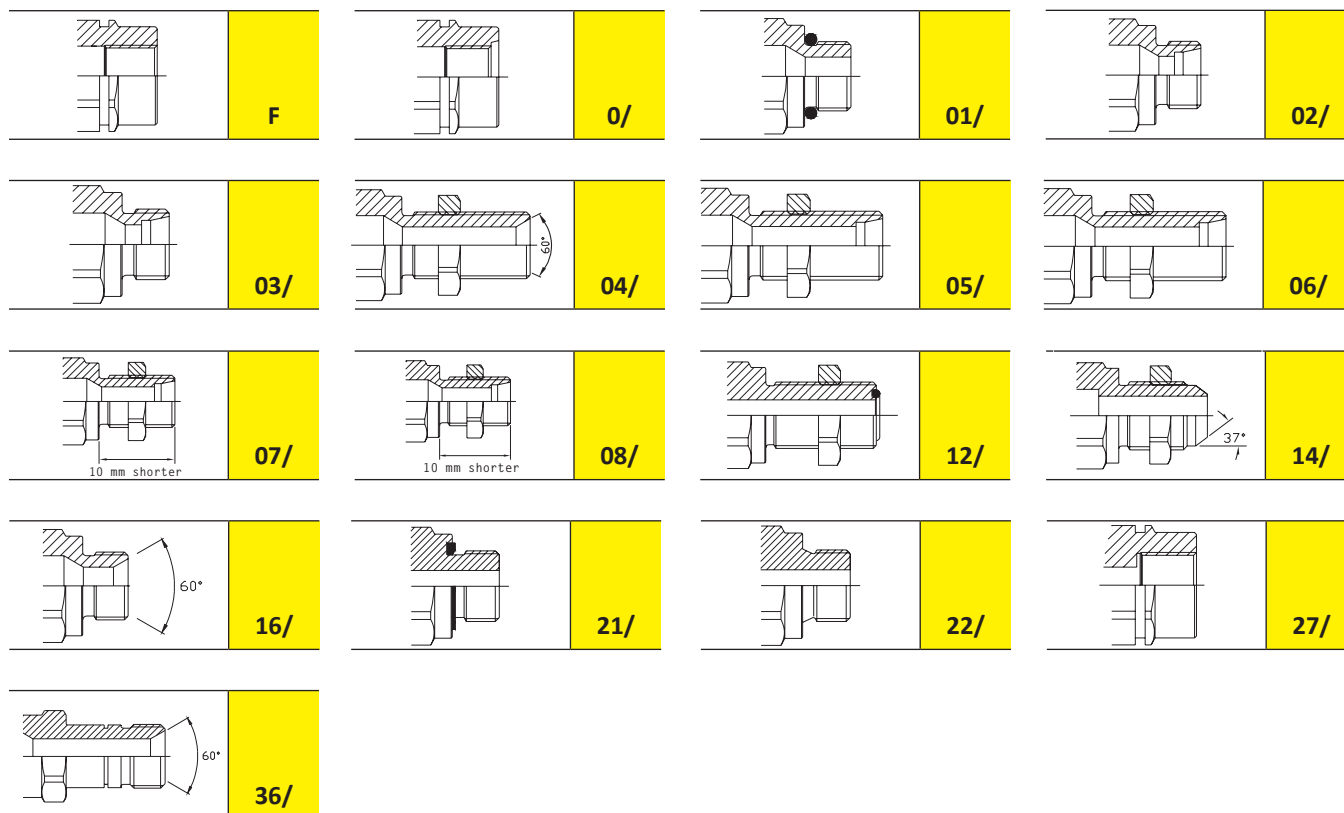

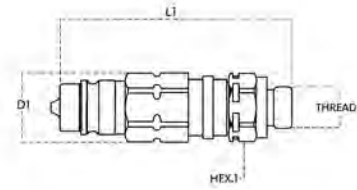

CNV for FastGrip

Size		Thread details			MALE									
mm	inch	Thread Type	Standard	Thread	Part Number	L (L1 + Thread)		D1		D3		HEX1		
						mm	inch	mm	inch	mm	inch	mm	inch	
12.5	1/2"	02/METRIC	ISO 8434-1-L	M18x1.5 MALE 12L	CNV08LM2/18 M	102	4.02	30	1.18	20.5	0.81	27	1.06	
12.5	1/2"	02/METRIC	ISO 8434-1-L	M22x2 MALE 15L	CNV08LM2/22 M	103	4.06	30	1.18	20.5	0.81	27	1.06	

CNV Accessories and Spares



PVC dust protections

page 243

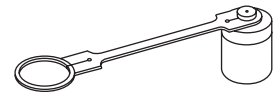

Aluminium dust protections

page 252

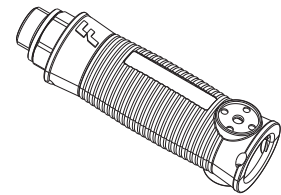

Line Identification System

page 260



Seals Kits

page 262

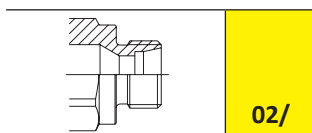



2NV

Standard male couplings, poppet valve, shielded.

Standard male couplings for agriculture application, with poppet valve and shielded valve-guide to prevent accidental disconnections caused by sudden backflow. ISO 7241 part A interchangeable.



Applications



Pressure Drop

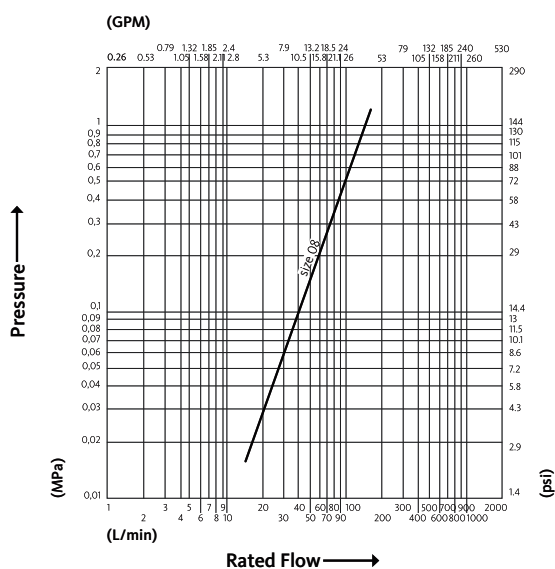

Test performed according to ISO 18869

Technical Specifications

dash	Size mm	inch	Working Pressure (MPa)	Flow Rate (l/min)	Spillage (ml)	Force to Connect (N)	Burst pressure (MPa)		
							Male	Female	Male + Female
08	12.5	1/2"	25	60	1.8	80	100	130	

Material	Steel
Seals	NBR
Working temperatures	- 25 °C to + 125 °C
Surface treatment	MATE 500 (CrIII)
Series Interchange	ISO 7241 part A

Valve Type	Poppet
Connection	
Disconnection	
Connection Under Pressure	Not Allowed



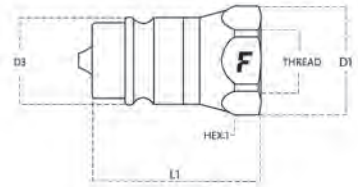

2NV

Size		Thread details			MALE									
mm	inch	Thread Type	Standard	Thread	Part Number	L (L1 + Thread)		D1		D3		HEX1		
						mm	inch	mm	inch	mm	inch	mm	inch	
12.5	1/2"	O/ SAE	ISO 11926-1	3/4"-16 UNF FEMALE ORB	2NV 12-12SAE M	47	1.85	30	1.18	20.5	0.81	27	1.06	
12.5	1/2"	F NPTF	ANSI B1.20.3	NPTF 1/2" FEMALE	2NV 12 NPT M	47	1.85	30	1.18	20.5	0.81	27	1.06	
12.5	1/2"	F BSPP	ISO 1179-1	BSPP 1/2" FEMALE	2NV 12 GAS M	47	1.85	30	1.18	20.5	0.81	27	1.06	
12.5	1/2"	O/ BSPP	BS 5380	BSPP 1/2 FEMALE ORB	2NV0/12 GAS M	47	1.85	30	1.18	20.5	0.81	27	1.06	
12.5	1/2"	O/ SAE	ISO 11926-1	7/8"-14 UNF FEMALE ORB	2NV 12-58SAE M	52.5	2.07	30	1.18	20.5	0.81	27	1.06	

2NV Accessories and Spares



PVC dust protections

page 243

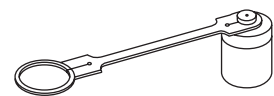

Aluminium dust protections

page 252

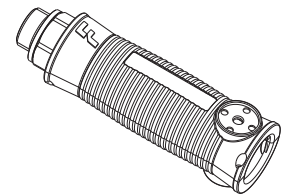

Line Identification System

pag 260



2NS

Standard male couplings, ball valve, shielded.

Male couplings for agriculture application, with ball valve and internal shielded valve-guide to prevent accidental disconnections caused by sudden backflow. ISO 7241 part A interchangeable.



Technical Specifications

dash	Size mm	inch	Working Pressure (MPa)	Flow Rate (l/min)	Spillage (ml)	Force to Connect (N)	Burst pressure (MPa)		
							Male	Female	Male + Female
08	12.5	1/2"	25	60	1.8	80	100	130	

Material	Steel
Seals	
Working temperatures	-25 °C to +125 °C
Surface treatment	MATE 500 (CrIII)
Series Interchange	ISO 7241 part A

Applications



Pressure Drop

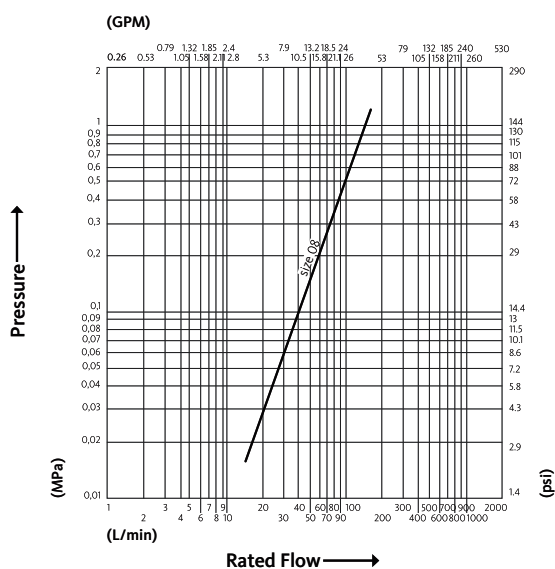

Test performed according to ISO 18869

Valve Type	Ball
Connection	
Disconnection	
Connection Under Pressure	Not Allowed



2NS

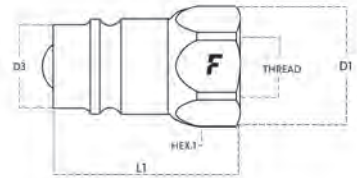

Size		Thread details			MALE								
mm	inch	Thread Type	Standard	Thread	Part Number	L (L1 + Thread)		D1		D3		HEX1	
						mm	inch	mm	inch	mm	inch	mm	inch
12.5	1/2"	F NPTF	ANSI B1.20.3	NPTF 1/2" FEMALE	2NS 12 NPT M	47	1.85	30	1.18	20.5	0.81	27	1.06

2NS Accessories and Spares



PVC dust protections

page 243

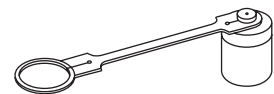

Aluminium dust protections

page 252

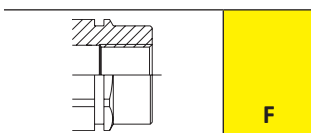

3CNV



Female couplings for agriculture with sleeve-retraction facilitator, ISO A interchange.

Female couplings connectable with the male part under residual pressure. A sleeve retraction facilitator helps to connect and disconnect. Compact design. ISO 7241 part A interchange.



Applications



Pressure Drop

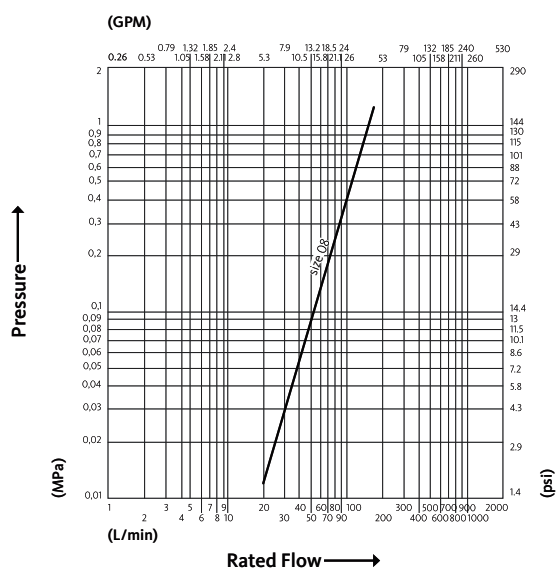

Test performed according to ISO 18869

Technical Specifications

dash	Size mm	inch	Working Pressure (MPa)	Flow Rate (l/min)	Spillage (ml)	Force to Connect (N)	Burst pressure (MPa)		
							Male	Female	Male + Female
08	12.5	1/2"	25	75	1.8	170	100	100	

Material	Steel
Seals	NBR
Working temperatures	- 25 °C to + 125 °C
Surface treatment	MATE 500 (CrIII)
Series Interchange	ISO 7241 part A

Valve Type	Poppet
Connection	Sleeve Retraction
Disconnection	Sleeve Retraction
Connection Under Pressure	Allowed Male Half up to W.P.



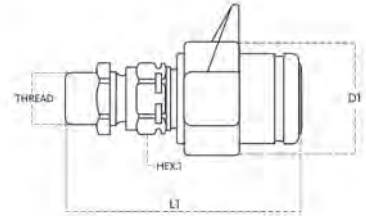

3CNV

Size		Thread details			FEMALE						
mm	inch	Thread Type	Standard	Thread	Part Number	L (L1 + Thread)		D1		HEX1	
						mm	inch	mm	inch	mm	inch
12.5	1/2"	12/ SAE	ISO 8434-3	13/16"-16 UN MALE BULKHEAD ORFS	3CNV0812/12S F	109	4.29	48	1.89	27	1.06

3CNV Accessories and Spares



PVC dust protections

page 243



Acetal Resin dust protections

page 250

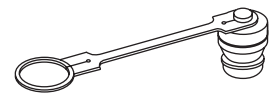

Aluminium dust protections

page 252



Seals Kits

page 262

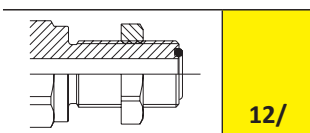

3NV

Push-pull female couplings for agriculture.

Female couplings connectable with the male part under residual pressure. A sleeve retraction facilitator helps to connect and disconnect. ISO 7241 part A interchange.



Technical Specifications

dash	Size mm	inch	Working Pressure (MPa)	Flow Rate (l/min)	Spillage (ml)	Force to Connect (N)	Burst pressure (MPa)		
							Male	Female	Male + Female
08	12.5	1/2"	25	75	1.8	110	100	100	

Material	Steel
Seals	NBR
Working temperatures	- 25 °C to + 125 °C
Surface treatment	MATE 500 (CrIII)
Series Interchange	ISO 7241 part A

Applications



Pressure Drop

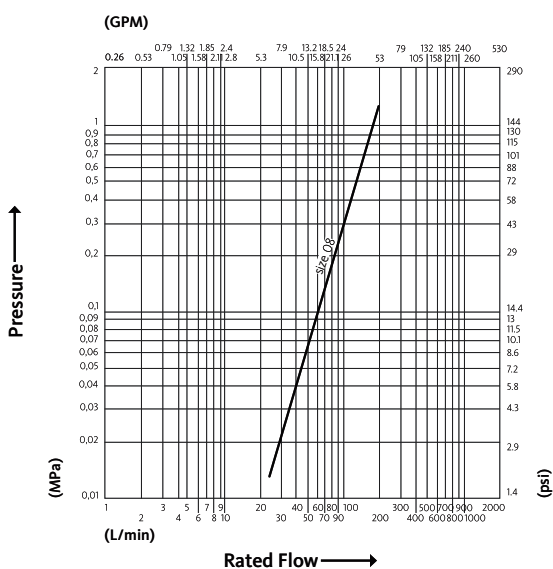

Test performed according to ISO 18869

Valve Type	Poppet
Connection	Sleeve Retraction
Disconnection	Sleeve Retraction
Connection Under Pressure	Allowed Male Half up to W.P.



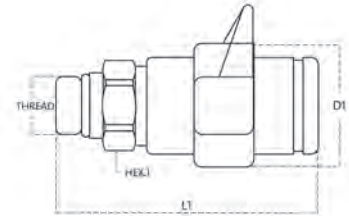

3NV

Size		Thread details			FEMALE						
mm	inch	Thread Type	Standard	Thread	Part Number	L (L1 + Thread)		D1		HEX1	
						mm	inch	mm	inch	mm	inch
12.5	1/2"	0/ SAE	ISO 11926-1	3/4"-16 UNF FEMALE ORB	3NV 12-12SAE F	100	3.94	48	1.89	27	1.06
12.5	1/2"	01/ SAE	ISO 11926-3	7/8"-14 UNF MALE	3NV1/78 UNF F	102.6	4.04	48	1.89	32	1.26

3NV Accessories and Spares



PVC dust protections

page 243



Acetal Resin dust protections

page 250

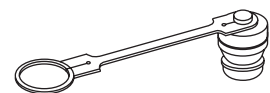

Aluminium dust protections

page 252



Seals Kits

page 262

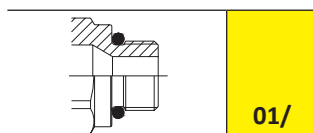
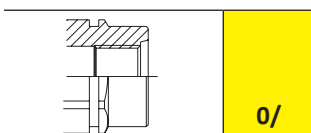

3CPV



Push-pull female couplings for agriculture, ISO-A interchange.

Push-pull female couplings designed for panel mounting and connection to flexible hoses. Connectable with male under residual pressure. Breakaway function. ISO 7241 part A interchange.



Applications



Pressure Drop

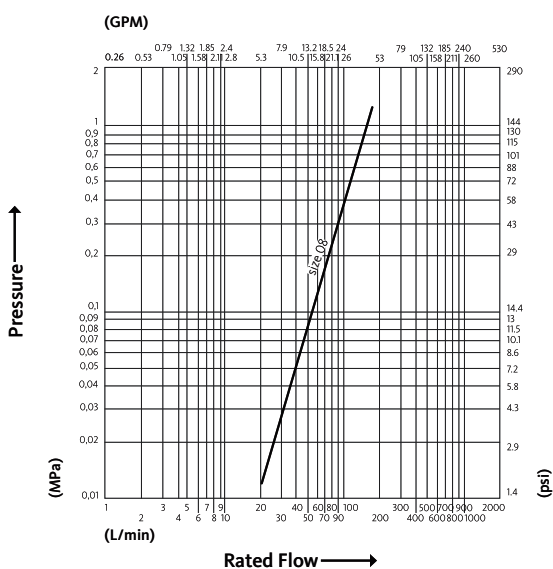

Test performed according to ISO 18869

Technical Specifications

dash	Size mm	inch	Working Pressure (MPa)	Flow Rate (l/min)	Spillage (ml)	Force to Connect (N)	Burst pressure (MPa)		
							Male	Female	Male + Female
08	12.5	1/2"	25	75	1.8	170	100	100	

Material	Steel
Seals	NBR
Working temperatures	- 25 °C to + 125 °C
Surface treatment	MATE 500 (CrIII)
Series Interchange	ISO 7241 part A

Valve Type	Poppet
Connection	Push to Connect*
Disconnection	Pull to Disconnect*
Connection Under Pressure	Allowed Male Half up to W.P.



* If panel mounted through the sleeve. Otherwise sleeve retraction.

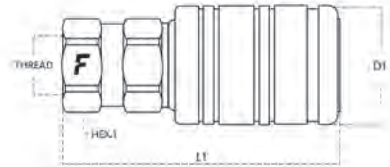

3CPV

Size		Thread details			FEMALE							
mm	inch	Thread Type	Standard	Thread	Part Number	L (L1 + Thread)		D1		HEX1		
						mm	inch	mm	inch	mm	inch	
12.5	1/2"	O/ SAE	ISO 11926-1	3/4" - 16 UNF FEMALE ORB	3CPV34UNF F MF	89.7	3.53	38	1.5	27	1.06	
12.5	1/2"	F NPTF	ANSI B1.20.3	NPTF 1/2" FEMALE	3CPV12NPT F T	89.7	3.53	38	1.5	27	1.06	
12.5	1/2"	O/ SAE	ISO 11926-1	3/4"-16 UNF FEMALE ORB	3CPV 34 UNF F	89.7	3.53	38	1.5	27	1.06	
12.5	1/2"	F BSPP	ISO 1179-1	BSPP 1/2" FEMALE	3CPV 12 GAS F	89.7	3.53	38	1.5	27	1.06	
12.5	1/2"	13/ SAE	ISO 8434-2	3/4"-16 UNF MALE JIC	3CPV13/12SAE F	91.7	3.61	38	1.5	27	1.06	

3CPV Accessories and Spares



PVC dust protections

page 243



Acetal Resin dust protections

page 250

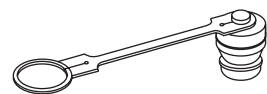

Aluminium dust protections

page 252



Seals Kits

page 262

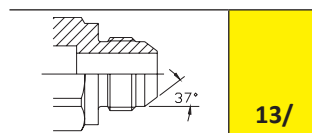
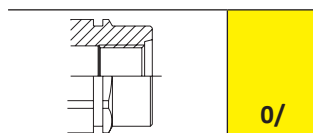
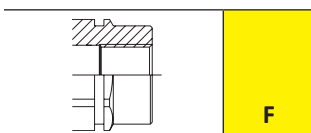

HF 3CFHF



Push-pull female couplings for agriculture with higher flow rate, up to 250 l/min.

Push-pull female couplings for high flow rate applications, connectable with male under residual pressure. Breakaway function. Can be screwed directly into valve ports or rigid pipes. ISO 7241 part A interchange. Flow rate up to 250 l/min.



Applications



Pressure Drop

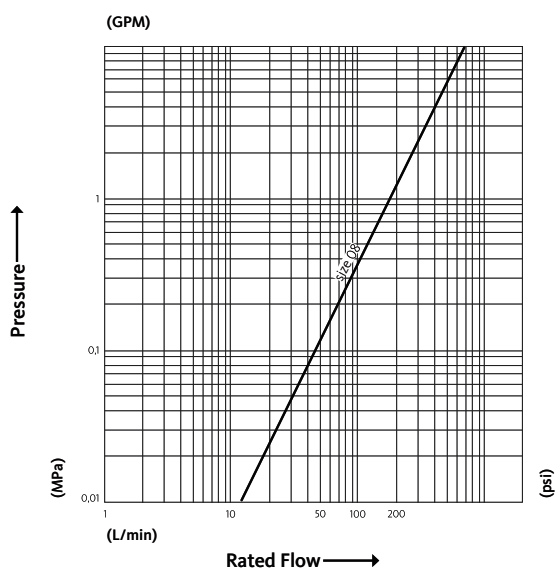

Test performed according to ISO 18869

Technical Specifications

dash	Size		Working Pressure (MPa)	Flow Rate (l/min)	Spillage (ml)	Force to Connect (N)	Burst pressure (MPa)		
	mm	inch					Male	Female	Male + Female
08	12.5	1/2"	25	70	2	250	100	110	

Material	Steel
Seals	PUR
Working temperatures	- 25 °C to + 100 °C
Surface treatment	MATE 500 (CrIII)
Series Interchange	ISO 7241 part A

Valve Type	Poppet
Connection	Push to Connect
Disconnection	Pull to Disconnect
Connection Under Pressure	Allowed Male Half up to W.P.



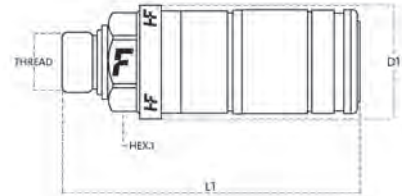

3CFHF

Size		Thread details			FEMALE						
mm	inch	Thread Type	Standard	Thread	Part Number	L (L1 + Thread)		D1		HEX1	
						mm	inch	mm	inch	mm	inch
12.5	1/2"	01/ SAE	ISO 11926-3	3/4"-16 UNF MALE	3CFHF081/12SAE F	108.2	4.26	42	1.65	32	1.26
12.5	1/2"	07/ METRIC	ISO 8434-1-L	M22x1.5 MALE BULKHEAD SHORT 15L	3CFHF087/2215 F	122.4	4.82	42	1.65	32	1.26
12.5	1/2"	07/ METRIC	ISO 8434-1-L	M18x1.5 MALE BULKHEAD SHORT 12L	3CFHF087/1815 F	121.2	4.77	42	1.65	32	1.26
12.5	1/2"	19/ METRIC	DIN 7642	M22x1.5 MALE	3CFHF0819/2215 F	134.7	5.3	42	1.65	32	1.26
12.5	1/2"	F NPTF	ANSI B1.20.3	NPTF 1/2" FEMALE	3CFHF08 12NPT F	106.2	4.18	42	1.65	27	1.06
12.5	1/2"	F BSPP	ISO 1179-1	BSPP 1/2" FEMALE	3CFHF08 12GAS F	106.2	4.18	42	1.65	27	1.06
12.5	1/2"	01/ METRIC	ISO 6149-2	M22x1.5 MALE	3CFHF081/2215 F	109.7	4.32	42	1.65	32	1.26
12.5	1/2"	01/ METRIC	ISO 6149-2	M18x1.5 MALE	3CFHF081/1815 F	112.2	4.42	42	1.65	32	1.26
12.5	1/2"	21/ METRIC	ISO 9974-2	M22x1.5 MALE	3CFHF0821/2215 F	109.2	4.3	42	1.65	32	1.26
12.5	1/2"	21/ METRIC	ISO 9974-2	M22x1.5 MALE	3CFHF21/22F U	109.2	4.3	42	1.65	32	1.26
12.5	1/2"	14/ SAE	ISO 8434-2	7/8"-14 UNF MALE BULKHEAD JIC	3CFHF14/78UNFF	127.7	5.03	42	1.65	32	1.26
12.5	1/2"	14/ SAE	ISO 8434-2	3/4"-16 UN MALE BULKHEAD JIC	3CFHF14/78UFVAL	162	6.38	42	1.65	32	1.26
12.5	1/2"	14/ SAE	ISO 8434-2	1-1/16"-12 UN MALE BULKHEAD JIC	3CFHF14/34UNFF	123.7	4.87	42	1.65	32	1.26
12.5	1/2"	F NPTF	ANSI B1.20.3	NPTF 1/2" FEMALE	3CFHF12NPT F T	106.2	4.18	42	1.65	27	1.06
12.5	1/2"	12/ SAE	ISO 8434-3	1"-14 UNS MALE BULKHEAD ORFS	3CFHF12/1UNSFU	129.2	5.09	42	1.65	32	1.26
12.5	1/2"	12/ SAE	ISO 8434-3	1"-14 UNS MALE BULKHEAD ORFS	3CFHF12/1UNS F	129.2	5.09	42	1.65	32	1.26
12.5	1/2"	01/ SAE	ISO 11926-3	7/8"-14 UNF MALE	3CFHF1/78UNF F	107.4	4.23	42	1.65	32	1.26
12.5	1/2"	01/ METRIC	ISO 6149-2	M22x1.5 MALE	3CFHF1/2215FJDC	109.7	4.32	40	1.57	38	1.5
12.5	1/2"	01/ METRIC	ISO 6149-2	M22x1.5 MALE	3CFHF1/2215F B	109.7	4.32	42	1.65	32	1.26
12.5	1/2"	04/ BSPP	ISO 8434-6	BSPP 3/8 MALE BULKHEAD	3CFHF0874/38GF	108.2	4.26	42	1.65	32	1.26
12.5	1/2"	07/ METRIC	ISO 8434-1-L	M26x1.5 MALE BULKHEAD SHORT 18L	3CFHF087/2615F	125.2	4.93	42	1.65	32	1.26
12.5	1/2"	07/ METRIC	ISO 8434-1-L	M22x1.5 MALE BULKHEAD SHORT 15L	3CFHF087/22FAG	137.6	5.42	40	1.57	38	1.5
12.5	1/2"	22/ BSPP	BS 5200	BSPP 1/2 MALE	3CFHF0822/12G FL	111.2	4.38	38	1.5	32	1.26
12.5	1/2"	21/ BSPP	ISO 1179-2	1/8" BSPP MALE	3CFHF0821/18FU	108.7	4.28	42	1.65	32	1.26
12.5	1/2"	01/ BSPP	BS 5380	G 5/8"	3CFHF081/58S F	108.7	4.28	42	1.65	32	1.26
12.5	1/2"	01/ BSPP	BS 5380	G 1/2"	3CFHF081/12G F	109.7	4.32	42	1.65	32	1.26
12.5	1/2"	08/ METRIC	ISO 8434-1-S	M24x1.5 MALE BULKHEAD SHORT 16S	3CFHF 8/2415 F	120.4	4.74	42	1.65	32	1.26
12.5	1/2"	0/ SAE	ISO 11926-1	3/4" - 16 UNF FEMALE ORB	3CFHF 34 UNF F	106.2	4.18	42	1.65	27	1.06
12.5	1/2"	01/ SAE	ISO 11926-3	1-1/16"-12 UN MALE	3CFHF1/34UNF F	123.7	4.87	42	1.65	32	1.26
12.5	1/2"	01/ METRIC	ISO 6149-2	M22x1.5 MALE	3CFHF1/2215F A	109.7	4.32	42	1.65	32	1.26
12.5	1/2"	01/ METRIC	ISO 6149-2	M22x1.5 MALE	3CFHF1/2215 FAG	109.7	4.32	42	1.65	32	1.26
12.5	1/2"	11/ SAE	ISO 8434-3	13/16"-16 UN MALE ORFS	3CFHF0811/12SFJ	110.2	4.34	40	1.57	38	1.50
12.5	1/2"	02/ METRIC	ISO 8434-1-L	M22x1.5 MALE 15L	3CFHF082/22F D	116.9	4.60	42	1.65	32	1.26
12.5	1/2"	07/ METRIC	ISO 8434-1-L	M18x1.5 MALE BULKHEAD SHORT 12L	3CFHF087/18F U	122.4	4.82	42	1.65	32	1.26
12.5	1/2"	07/ METRIC	ISO 8434-1-L	M22x1.5 MALE BULKHEAD SHORT 15L	3CFHF087/22F U	122.4	4.82	42	1.65	32	1.26
12.5	1/2"	01/ METRIC	ISO 6149-2	M22x1.5 MALE	3CFHF1/2215F C	109.7	4.32	40	1.57	38	1.50

3CFHF

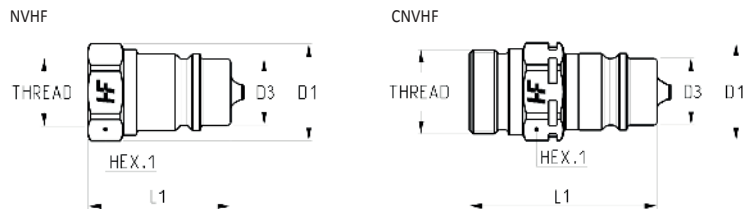

Size		Thread details			MALE									
mm	inch	Thread Type	Standard	Thread	Part Number	L (L1 + Thread)		D1		D3		HEX1		
						mm	inch	mm	inch	mm	inch	mm	inch	
12.5	1/2"	F BSPP	ISO 1179-1	BSPP 1/2 FEMALE	NVHF08 GAS M	44	1.73	30	1.18	20.5	0.81	27	1.06	
12.5	1/2"	F BSPP	ISO 1179-1	BSPP 3/8 FEMALE	CNVHF08 38GAS M	57	2.24	30	1.18	20.5	0.81	27	1.06	
12.5	1/2"	O2/ METRIC	ISO 8434-1-L	M18x1.5 MALE 12L	CNVHF082/1815 M	57	2.24	30	1.18	20.5	0.81	27	1.06	
12.5	1/2"	O2/ METRIC	ISO 8434-1-L	M22x1.5 MALE 15L	CNVHF082/2215 M	58	2.28	30	1.18	20.5	0.81	27	1.06	
12.5	1/2"	O2/ METRIC	ISO 8434-1-L	M26x1.5 MALE 18L	CNVHF082/2615 M	58	2.28	30	1.18	20.5	0.81	27	1.06	

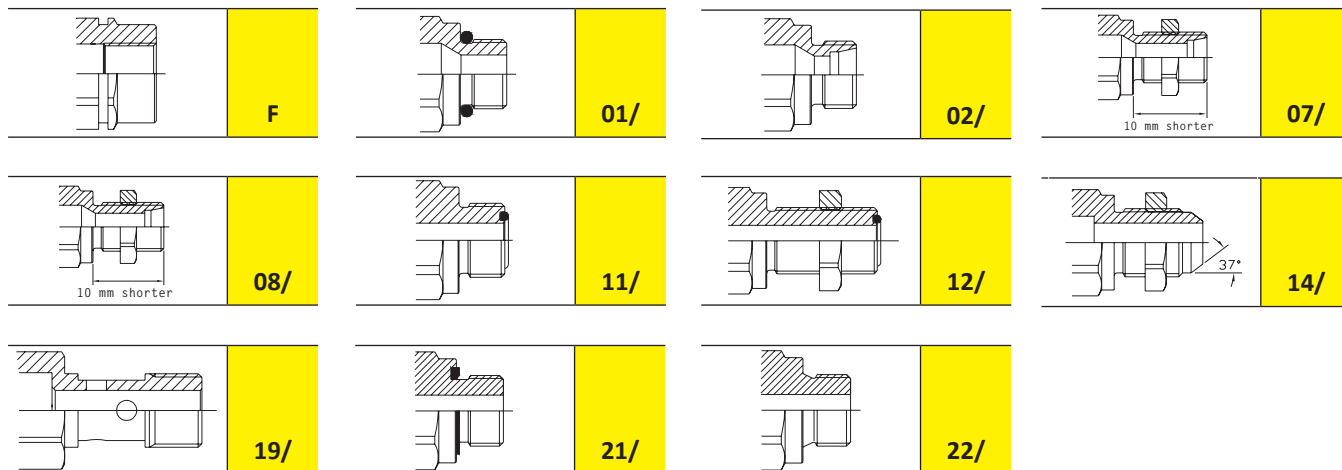

3CFHF Accessories and Spares



PVC dust protections

page 243



Acetal Resin dust protections

page 250

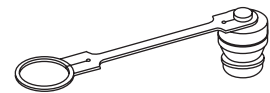

Aluminium dust protections

page 252

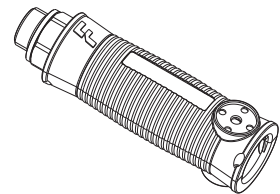

Line Identification System

page 260

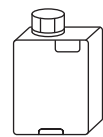
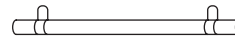
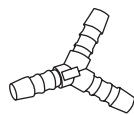
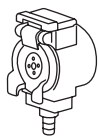

Modular automatic caps with Oil Collecting System

page 261



Seals Kits

page 262

HF 3CKHF



Compact push-pull female couplings for agriculture with higher flow rate, up to 250 l/min.

Compact push-pull female couplings for application with higher flow rate and limited space, connectable with male under residual pressure. Breakaway function. Can be screwed directly into valve ports or rigid pipes. ISO 7241 part A interchange. Flow rate up to 250 l/min. Reduced dimensions: 15 mm shorter than standard version.



Applications



Pressure Drop

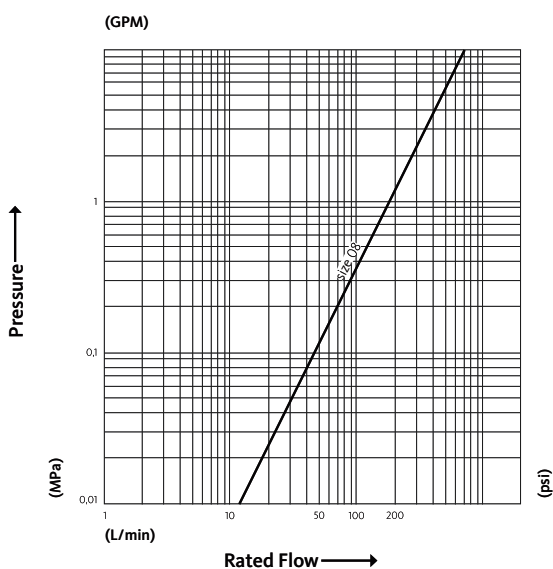

Test performed according to ISO 18869

Technical Specifications

dash	Size mm	inch	Working Pressure (MPa)	Flow Rate (l/min)	Spillage (ml)	Force to Connect (N)	Burst pressure (MPa)		
							Male	Female	Male + Female
08	12.5	1/2"	25	70	2	250	100	110	

Material	Steel
Seals	PUR
Working temperatures	- 25 °C to + 100 °C
Surface treatment	MATE 500 (CrIII)
Series Interchange	ISO 7241 part A

Valve Type	Poppet
Connection	Push to Connect
Disconnection	Pull to Disconnect
Connection Under Pressure	Allowed Male Half up to W.P.



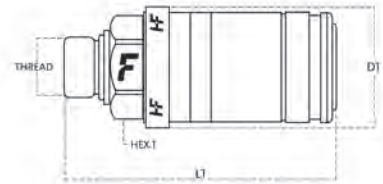

3CKHF

Size		Thread details			FEMALE						
mm	inch	Thread Type	Standard	Thread	Part Number	L (L1 + Thread)		D1		HEX1	
						mm	inch	mm	inch	mm	inch
12.5	1/2"	07/ METRIC	ISO 8434-1-L	M26x1.5 MALE BULKHEAD SHORT 18L	3CKHF087/2615 F	110.2	4.34	42	1.65	32	1.26
12.5	1/2"	07/ METRIC	ISO 8434-1-L	M22x1.5 MALE BULKHEAD SHORT 15L	3CKHF087/2215 F	107.4	4.23	42	1.65	32	1.26
12.5	1/2"	07/ METRIC	ISO 8434-1-L	M18x1.5 MALE BULKHEAD SHORT 12L	3CKHF087/1815 F	106.2	4.18	42	1.65	32	1.26
12.5	1/2"	01/ METRIC	ISO 6149-2	M22x1.5 MALE	3CKHF081/2215 F	97.4	3.73	42	1.65	32	1.26
12.5	1/2"	21/ METRIC	ISO 9974-2	M22x1.5 MALE	3CKHF0821/2215 F	94.2	3.71	42	1.65	32	1.26

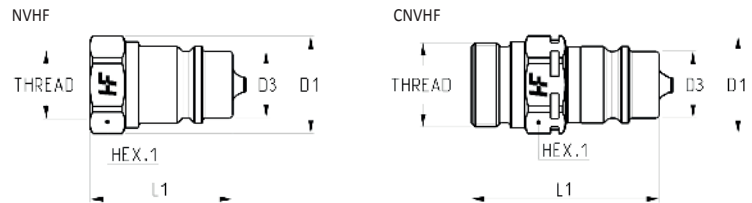

Size		Thread details			MALE								
mm	inch	Thread Type	Standard	Thread	Part Number	L (L1 + Thread)		D1		D3		HEX1	
						mm	inch	mm	inch	mm	inch	mm	inch
12.5	1/2"	F BSPP	ISO 1179-1	BSPP 1/2 FEMALE	NVHF08 GAS M	44	1.73	30	1.18	20.5	0.81	27	1.06
12.5	1/2"	F BSPP	ISO 1179-1	BSPP 3/8 FEMALE	CNVHF08 38GAS M	57	2.24	30	1.18	20.5	0.81	27	1.06
12.5	1/2"	02/ METRIC	ISO 8434-1-L	M18x1.5 MALE 12L	CNVHF082/1815 M	57	2.24	30	1.18	20.5	0.81	27	1.06
12.5	1/2"	02/ METRIC	ISO 8434-1-L	M22x1.5 MALE 15L	CNVHF082/2215 M	58	2.28	30	1.18	20.5	0.81	27	1.06
12.5	1/2"	02/ METRIC	ISO 8434-1-L	M26x1.5 MALE 18L	CNVHF082/2615 M	58	2.28	30	1.18	20.5	0.81	27	1.06

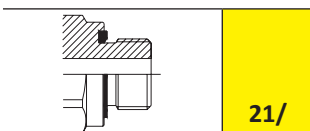
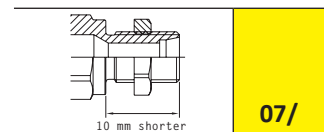
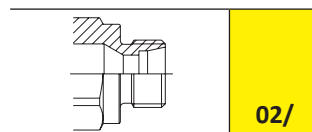
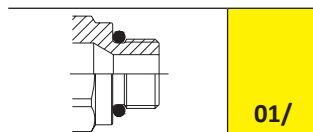
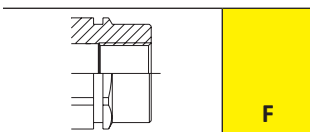

3CKHF Accessories and Spares



PVC dust protections

page 243



Acetal Resin dust protections

page 250

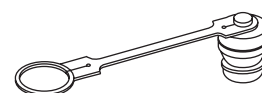

Aluminium dust protections

page 252

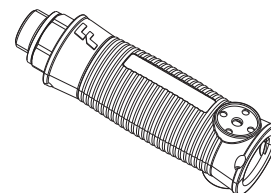

Line Identification System

page 260

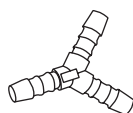
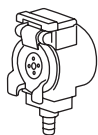

Modular automatic caps with Oil Collecting System

page 261



Seals Kits

page 262



4PV

Push-pull female couplings for agriculture with pressure relief valve.

Push-pull female couplings, designed for panel mounting installation. Thanks to a microvalve it's possible to easily spill some oil when necessary in order to relieve the residual pressure into the female half. BSP and NPT female thread available. Breakaway function. ISO 7241 part A interchangeable.



Applications



Pressure Drop

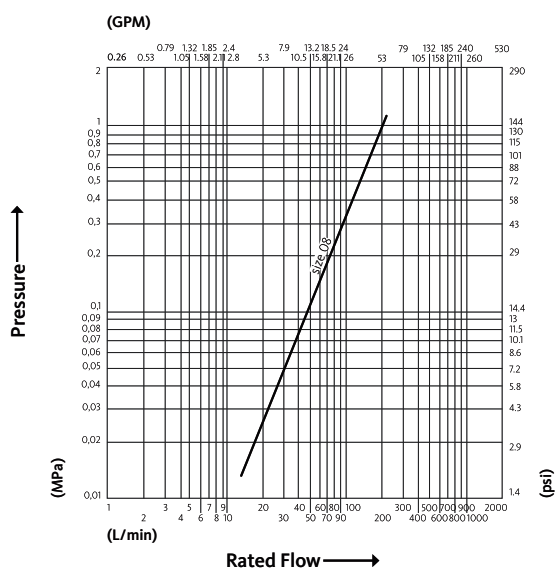

Test performed according to ISO 18869

Technical Specifications

dash	Size		Working Pressure (MPa)	Flow Rate (l/min)	Spillage (ml)	Force to Connect (N)	Burst pressure (MPa)		
	mm	inch					Male	Female	Male + Female
08	12.5	1/2"	25	75	1.8	110	100	100	

Material	Steel
Seals	NBR
Working temperatures	- 25 °C to + 125 °C
Surface treatment	MATE 500 (CrIII)
Series Interchange	ISO 7241 part A

Valve Type	Poppet
Connection	Push to Connect*
Disconnection	Pull to Disconnect*
Connection Under Pressure	Allowed Residual



* If panel mounted through the sleeve. Otherwise sleeve retraction.

4PV

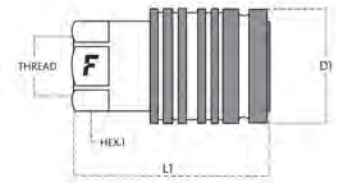

Size		Thread details			FEMALE						
mm	inch	Thread Type	Standard	Thread	Part Number	L (L1 + Thread)		D1		HEX1	
						mm	inch	mm	inch	mm	inch
12.5	1/2"	F BSPP	ISO 1179-1	BSPP 1/2" FEMALE	4PV 12 GAS F	66	2.6	38	1.5	27	1.06

4PV Accessories and Spares



PVC dust protections

page 243

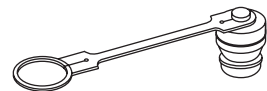

Aluminium dust protections

page 252



Seals Kits

page 262

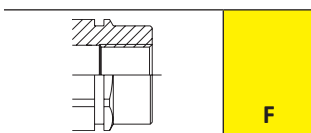



4CPV

Push-pull female couplings for agriculture with pressure relief valve.

Push-pull female couplings, designed for panel mounting installation. Thanks to a microvalve it's possible to easily spill some oil when necessary in order to relieve the residual pressure into the female half. Wide range of male threads available. Breakaway function. ISO 7241 part A interchangeable.



Applications



Pressure Drop

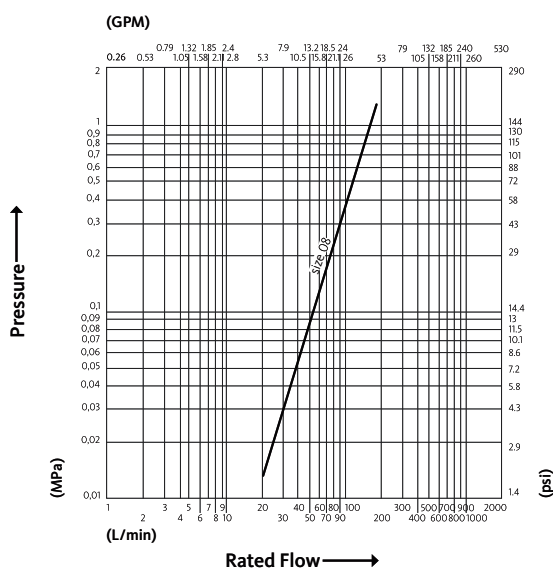

Test performed according to ISO 18869

Technical Specifications

dash	Size		Working Pressure (MPa)	Flow Rate (l/min)	Spillage (ml)	Force to Connect (N)	Burst pressure (MPa)		
	mm	inch					Male	Female	Male + Female
08	12.5	1/2"	25	75	1.8	110	100	100	

Material	Steel
Seals	NBR
Working temperatures	- 25 °C to + 125 °C
Surface treatment	MATE 500 (CrIII)
Series Interchange	ISO 7241 part A

Valve Type	Poppet
Connection	Push to Connect*
Disconnection	Pull to Disconnect*
Connection Under Pressure	Allowed Residual



* If panel mounted through the sleeve. Otherwise sleeve retraction.

4CPV

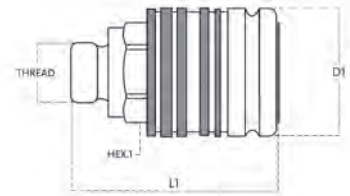

Size		Thread details			FEMALE						
mm	inch	Thread Type	Standard	Thread	Part Number	L (L1 + Thread)		D1		HEX1	
						mm	inch	mm	inch	mm	inch
12.5	1/2"	02/ METRIC	ISO 8434-1-L	M18x1.5 MALE 12L	4CPV082/1815 F	62.3	2.45	38	1.5	27	1.06

4CPV Accessories and Spares



PVC dust protections

page 243

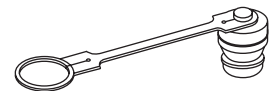

Aluminium dust protections

page 252



Seals Kits

page 262

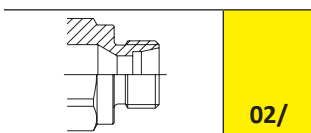

4NV

Standard couplings for agriculture with pressure relief valve.

Standard 1/2" couplings for agriculture allowing an easy relief of residual pressure thanks to a microvalve. ISO 7241 part A interchange.



Technical Specifications

dash	Size mm	inch	Working Pressure (MPa)	Flow Rate (l/min)	Spillage (ml)	Force to Connect (N)	Burst pressure (MPa)		
							Male	Female	Male + Female
08	12.5	1/2"	25	75	1.8	110	100	100	100

Material	Steel
Seals	NBR
Working temperatures	- 25 °C to + 125 °C
Surface treatment	MATE 500 (CrIII)
Series Interchange	ISO 7241 part A

Applications



Pressure Drop

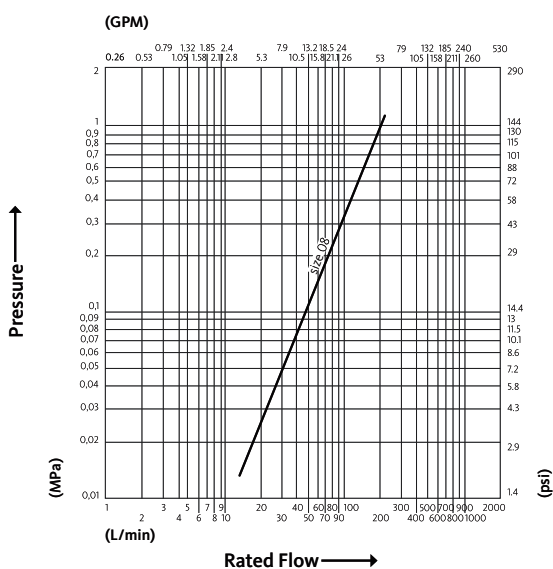

Test performed according to ISO 18869

Valve Type	Poppet
Connection	Sleeve Retraction
Disconnection	Sleeve Retraction
Connection Under Pressure	Allowed Residual



4NV

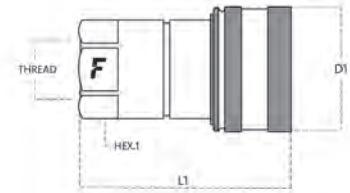

Size		Thread details			FEMALE						
mm	inch	Thread Type	Standard	Thread	Part Number	L (L1 + Thread)		D1		HEX1	
						mm	inch	mm	inch	mm	inch
12.5	1/2"	F JPT	UNI EN 10226-2	RC 1 FEMALE (JPT)	4NV 12 JPT F	66	2.6	38	1.5	27	1.06
12.5	1/2"	F BSPP	ISO 1179-1	BSPP 1/2" FEMALE	4NV 12 GAS F	66	2.6	38	1.5	27	1.06

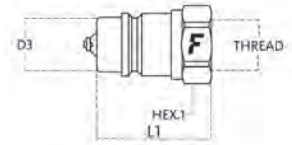

Size		Thread details			MALE								
mm	inch	Thread Type	Standard	Thread	Part Number	L (L1 + Thread)		D1		D3		HEX1	
						mm	inch	mm	inch	mm	inch	mm	inch
12.5	1/2"	F JPT	UNI EN 10226-2	RC 1/2 FEMALE (JPT)	4NV 12 JPT M	44	1.73	30	1.18	20.5	0.81	27	1.06
12.5	1/2"	O/ SAE	ISO 11926-1	3/4"-16 UNF FEMALE ORB	4NV 12-12SAE M	44	1.73	30	1.18	20.5	0.81	27	1.06
12.5	1/2"	F NPTF	ANSI B1.20.3	NPTF 1/2" FEMALE	4NV 12 NPT M	44	1.73	30	1.18	20.5	0.81	27	1.06
12.5	1/2"	F BSPP	ISO 1179-1	BSPP 1/2" FEMALE	4NV 12 GAS M	44	1.73	30	1.18	20.5	0.81	27	1.06

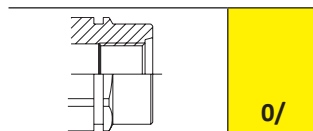
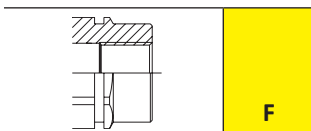

4NV Accessories and Spares



PVC dust protections

page 243

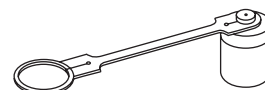
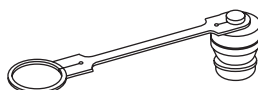

Aluminium dust protections

page 252

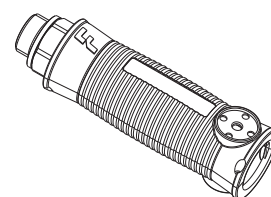

Line Identification System

page 260



Seals Kits

page 262

HF 4SRHF



Push-pull female couplings for agriculture with higher flow rate, up to 250 l/min.

Push-pull female couplings for high flow rate applications, connectable under residual pressure in both male and female side. Can be screwed directly into valve ports or rigid pipes. Breakaway function. ISO 7241 part A interchange. Flow rate up to 250 l/min.



Applications



Pressure Drop

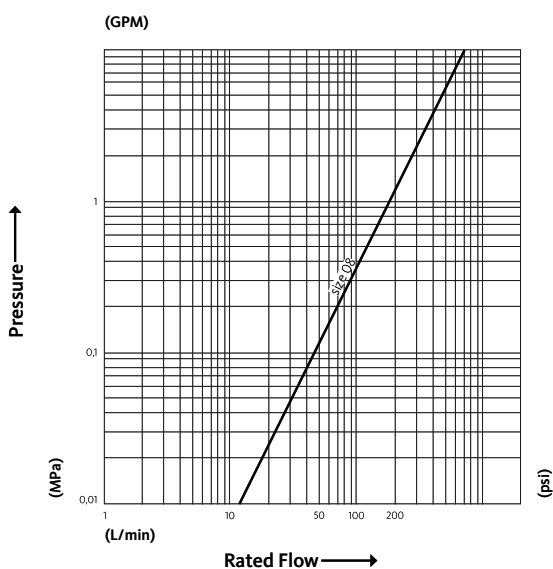

Test performed according to ISO 18869

Technical Specifications

dash	Size		Working Pressure (MPa)	Flow Rate (l/min)	Spillage (ml)	Force to Connect (N)	Burst pressure (MPa)		
	mm	inch					Male	Female	Male + Female
08	12.5	1/2"	25	70	2	250		100	100

Material	Steel
Seals	PUR
Working temperatures	- 25 °C to + 100 °C
Surface treatment	MATE 500 (CrIII)
Series Interchange	ISO 7241 part A

Valve Type	Poppet
Connection	Push to Connect
Disconnection	Pull to Disconnect
Connection Under Pressure	Allowed Both Halves up to W.P.



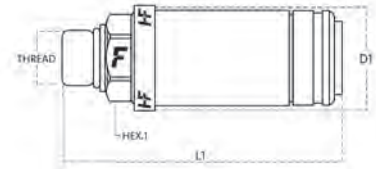

4SRHF

Size		Thread details			FEMALE							
mm	inch	Thread Type	Standard	Thread	Part Number	L (L1 + Thread)		D1		HEX1		
						mm	inch	mm	inch	mm	inch	
12.5	1/2"	01/ SAE	ISO 11926-3	3/4"-16 UNF MALE	4SRHF081/12SAE F	108.2	4.26	42	1.65	32	1.26	
12.5	1/2"	07/ METRIC	ISO 8434-1-L	M22x1.5 MALE BULKHEAD SHORT 15L	4SRHF087/2215 F	122.4	4.82	32	1.26	42	1.65	
12.5	1/2"	07/ METRIC	ISO 8434-1-L	M18x1.5 MALE BULKHEAD SHORT 12L	4SRHF087/1815 F	121.2	4.77	42	1.65	32	1.26	
12.5	1/2"	19/ METRIC	DIN 7642	M22x1.5 MALE	4SRHF0819/2215 F	133.7	5.26	42	1.65	32	1.26	
12.5	1/2"	F NPTF	ANSI B1.20.3	NPTF 1/2" FEMALE	4SRHF08 12NPT F	106.2	4.18	42	1.65	27	1.06	
12.5	1/2"	F BSPP	ISO 1179-1	BSPP 1/2" FEMALE	4SRHF08 12GAS F	106.2	4.18	42	1.65	27	1.06	
12.5	1/2"	01/ METRIC	ISO 6149-2	M22x1.5 MALE	4SRHF081/2215 F	109.7	4.32	42	1.65	32	1.26	
12.5	1/2"	01/ METRIC	ISO 6149-2	M18x1.5 MALE	4SRHF081/1815 F	112.2	4.42	42	1.65	32	1.26	
12.5	1/2"	21/ METRIC	ISO 9974-2	M22x1.5 MALE	4SRHF0821/2215 F	109.2	4.3	42	1.65	32	1.26	
12.5	1/2"	04/ BSPP	ISO 8434-6	BSPP 5/8 MALE BULKHEAD	4SRHF084/58GF H	129.7	5.11	42	1.65	32	1.26	
12.5	1/2"	04/ BSPP	ISO 8434-6	BSPP 3/8 MALE BULKHEAD	4SRHF084/38GF H	129.7	5.11	42	1.65	32	1.26	
12.5	1/2"	04/ BSPP	ISO 8434-6	BSPP 1/2 MALE BULKHEAD	4SRHF084/12GF H	130.2	5.13	42	1.65	32	1.26	
12.5	1/2"	22/ BSPP	BS 5200	BSPP 3/8 MALE	4SRHF0822/38GFH	109.2	4.3	42	1.65	32	1.26	
12.5	1/2"	14/ SAE	ISO 8434-2	7/8"-14 UNF MALE BULKHEAD JIC	4SRHF0814/58SFH	127.7	5.03	42	1.65	32	1.26	
12.5	1/2"	01/ METRIC	ISO 6149-2	M22x1.5 MALE	4SRHF081/22FVAC	109.7	4.32	42	1.65	32	1.26	
12.5	1/2"	0/ SAE	ISO 11926-1	3/4"-16 UNF FEMALE ORB	4SRHF08 12SF H	106.2	4.18	42	1.65	27	1.06	
12.5	1/2"	12/ SAE	ISO 8434-3	1-3/16"-12 UN MALE BULKHEAD ORFS	4SRHF0812/34SFH	132	5.20	42	1.65	36	1.42	

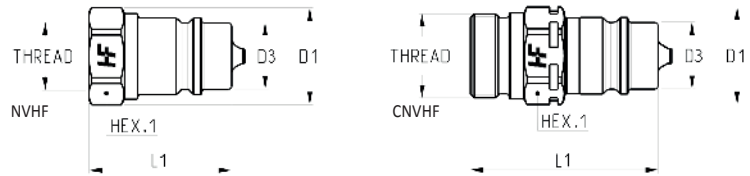

Size		Thread details			MALE								
mm	inch	Thread Type	Standard	Thread	Part Number	L (L1 + Thread)		D1		D3		HEX1	
						mm	inch	mm	inch	mm	inch	mm	inch
12.5	1/2"	F BSPP	ISO 1179-1	BSPP 1/2 FEMALE	NVHF08 GAS M	44	1.73	30	1.18	20.5	0.81	27	1.06
12.5	1/2"	F BSPP	ISO 1179-1	BSPP 3/8 FEMALE	CNVHF08 38GAS M	57	2.24	30	1.18	20.5	0.81	27	1.06
12.5	1/2"	02/ METRIC	ISO 8434-1-L	M18x1.5 MALE 12L	CNVHF082/1815 M	57	2.24	30	1.18	20.5	0.81	27	1.06
12.5	1/2"	02/ METRIC	ISO 8434-1-L	M22x1.5 MALE 15L	CNVHF082/2215 M	58	2.28	30	1.18	20.5	0.81	27	1.06
12.5	1/2"	02/ METRIC	ISO 8434-1-L	M26x1.5 MALE 18L	CNVHF082/2615 M	58	2.28	30	1.18	20.5	0.81	27	1.06

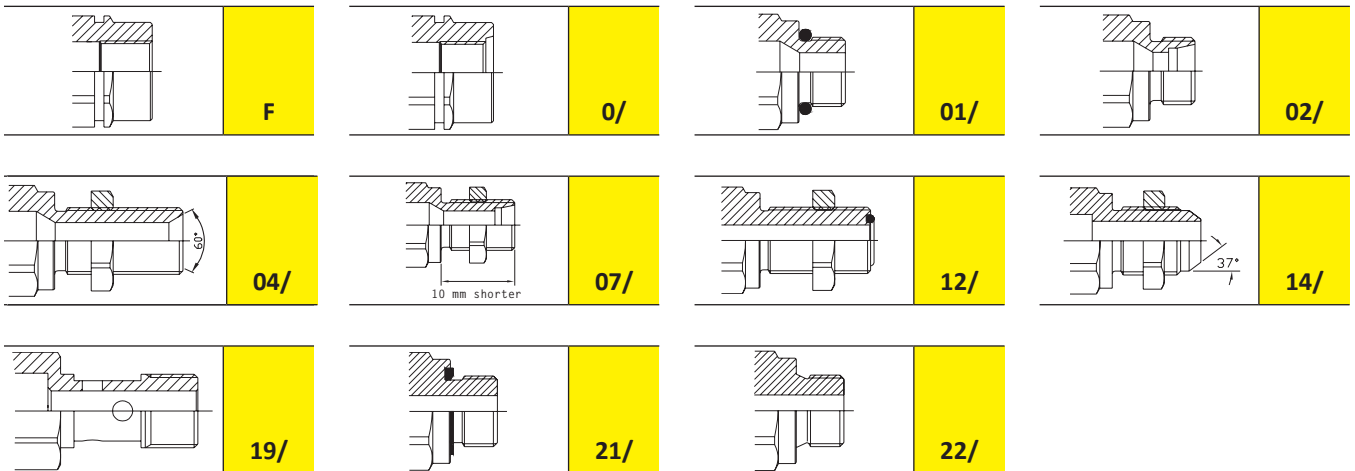

4SRHF Accessories and Spares



PVC dust protections

page 243



Acetal Resin dust protections

page 250

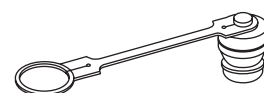

Aluminium dust protections

page 252

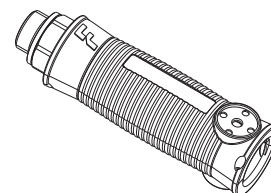

Line Identification System

page 260

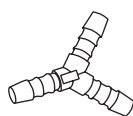
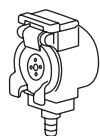

Modular automatic caps with Oil Collecting System

page 261



Seals Kits

page 262

HF 4SKHF



Compact push-pull female couplings for agriculture with higher flow rate, up to 250 l/min.

Compact push-pull female couplings for application with higher flow rate and limited space, connectable under residual pressure in both male and female side. Can be screwed directly into valve ports or rigid pipes. Breakaway function. ISO 7241 part A interchange. Flow rate up to 250 l/min. Reduced dimensions: 15 mm shorter than standard version.



Applications



Pressure Drop

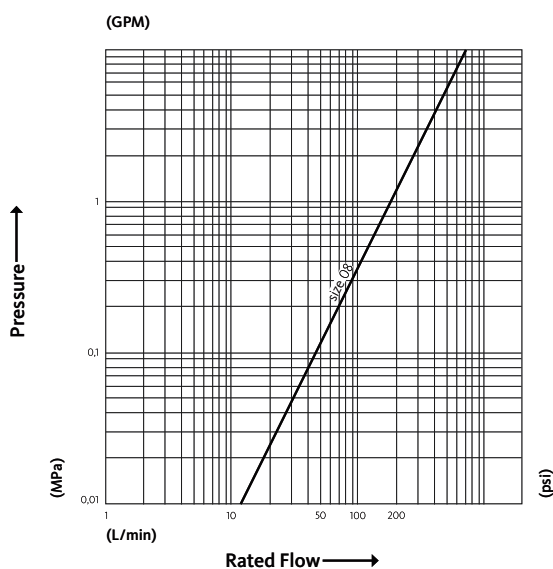

Test performed according to ISO 18869

Technical Specifications

dash	Size mm	inch	Working Pressure (MPa)	Flow Rate (l/min)	Spillage (ml)	Force to Connect (N)	Burst pressure (MPa)		
							Male	Female	Male + Female
08	12.5	1/2"	25	70	2	250	100	100	

Material	Steel
Seals	PUR
Working temperatures	- 25 °C to + 100 °C
Surface treatment	MATE 500 (CrIII)
Series Interchange	ISO 7241 part A

Valve Type	Poppet
Connection	Push to Connect
Disconnection	Pull to Disconnect
Connection Under Pressure	Allowed Both Halves up to W.P.



4SKHF

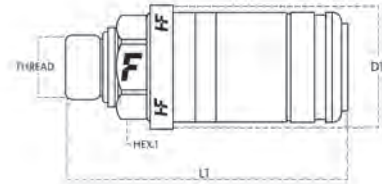

Size		Thread details			FEMALE						
mm	inch	Thread Type	Standard	Thread	Part Number	L (L1 + Thread)		D1		HEX1	
						mm	inch	mm	inch	mm	inch
12.5	1/2"	07/ METRIC	ISO 8434-1-L	M26x1.5 MALE BULKHEAD SHORT 18L	4SKHF087/2615 F	110.2	4.34	42	1.65	32	1.26
12.5	1/2"	07/ METRIC	ISO 8434-1-L	M22x1.5 MALE BULKHEAD SHORT 15L	4SKHF087/2215 F	107.4	4.23	42	1.65	32	1.26
12.5	1/2"	07/ METRIC	ISO 8434-1-L	M18x1.5 MALE BULKHEAD SHORT 12L	4SKHF087/1815 F	106.2	4.18	42	1.65	32	1.26
12.5	1/2"	01/ METRIC	ISO 6149-2	M22x1.5 MALE	4SKHF081/2215 F	94.7	3.73	42	1.65	32	1.26
12.5	1/2"	21/ METRIC	ISO 9974-2	M22x1.5 MALE	4SKHF0821/2215 F	94.2	3.71	42	1.65	32	1.26

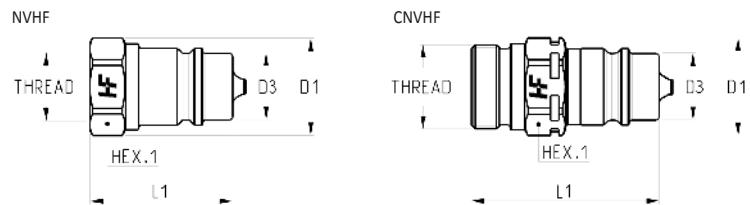

Size		Thread details			MALE								
mm	inch	Thread Type	Standard	Thread	Part Number	L (L1 + Thread)		D1		D3		HEX1	
						mm	inch	mm	inch	mm	inch	mm	inch
12.5	1/2"	F BSPP	ISO 1179-1	BSPP 1/2 FEMALE	NVHF08 GAS M	44	1.73	30	1.18	20.5	0.81	27	1.06
12.5	1/2"	F BSPP	ISO 1179-1	BSPP 3/8 FEMALE	CNVHF08 38GAS M	57	2.24	30	1.18	20.5	0.81	27	1.06
12.5	1/2"	02/ METRIC	ISO 8434-1-L	M18x1.5 MALE 12L	CNVHF082/1815 M	57	2.24	30	1.18	20.5	0.81	27	1.06
12.5	1/2"	02/ METRIC	ISO 8434-1-L	M22x1.5 MALE 15L	CNVHF082/2215 M	58	2.28	30	1.18	20.5	0.81	27	1.06
12.5	1/2"	02/ METRIC	ISO 8434-1-L	M26x1.5 MALE 18L	CNVHF082/2615 M	58	2.28	30	1.18	20.5	0.81	27	1.06

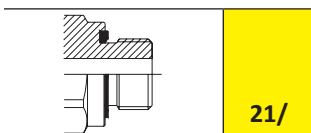
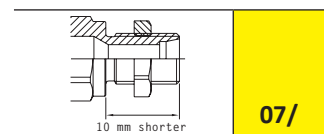
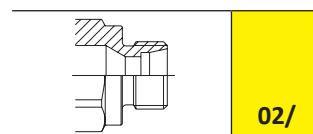
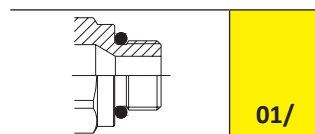
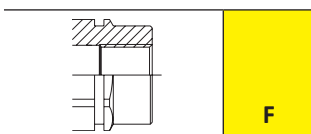

4SKHF Accessories and Spares



PVC dust protections

page 243



Acetal Resin dust protections

page 250

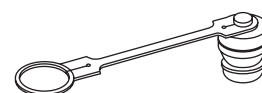

Aluminium dust protections

page 252

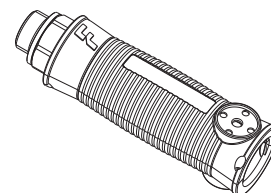

Line Identification System

page 260

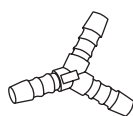
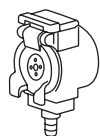

Modular automatic caps with Oil Collecting System

page 261



Seals Kits

page 262

6DNPV



Female couplings for agriculture.

Quick-release female couplings for rigid mounting connectable with male and female under pressure, disconnectable under pressure with low effort.



Applications



Pressure Drop

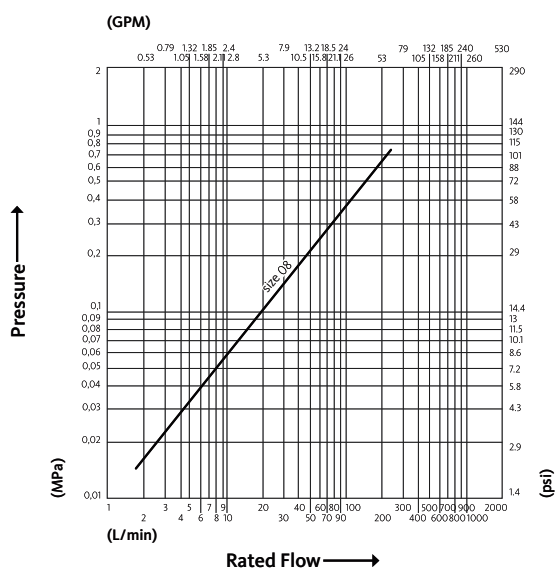

Test performed according to ISO 18869

Technical Specifications

dash	Size		Working Pressure (MPa)	Flow Rate (l/min)	Spillage (ml)	Force to Connect (N)	Burst pressure (MPa)		
	mm	inch					Male	Female	Male + Female
08	12.5	1/2"	25	50	1.4	255	100	100	

Material	Steel
Seals	NBR; PUR
Working temperatures	- 25 °C to + 125 °C
Surface treatment	MATE 500 (CrIII)
Series Interchange	ISO 7241 part A

Valve Type	Poppet
Connection	Push to Connect
Disconnection	Pull to Disconnect
Connection Under Pressure	Allowed



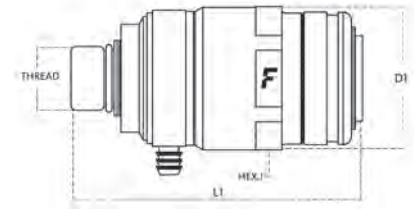

6DNPV

Size		Thread details			FEMALE						
mm	inch	Thread Type	Standard	Thread	Part Number	L (L1 + Thread)		D1		HEX1	
						mm	inch	mm	inch	mm	inch
12.5	1/2"	01/ METRIC	ISO 6149-2	M22x1.5 MALE	6DNPV081/22F A1	101.7	4	50	1.97	46	1.81
12.5	1/2"	01/ METRIC	ISO 6149-2	M22x1.5 MALE	6DNPV081/22F B	101.7	4	50	1.97	46	1.81

Part Number 6DNPV08 1/22F A1 has single oil collector port.
 Part Number 6DNPV08 1/22F B has double oil collector port.

To order modular automatic caps for 6DNPV with oil-collecting system, part number TARV 34, please contact Faster.

6DNPV Accessories and Spares

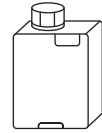
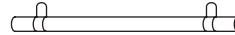
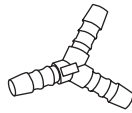
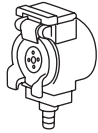

Modular automatic caps with Oil Collecting System

page 261



Seals Kits

page 262

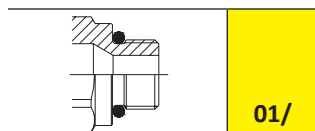

VA

Screw to connect couplings for braking systems.

VA couplings are commonly used in agriculture market for braking systems and consequently very similar to VF braking valves. Characterized by screw-to-connect sleeve, their interchangeability is based on market driven standards.



Technical Specifications

dash	Size		Working Pressure (MPa)	Flow Rate (l/min)	Spillage (ml)	Force to Connect (N)	Burst pressure (MPa)		
	mm	inch					Male	Female	Male + Female
06	10	3/8"	22	40	0.05	90	90	110	

Material	Steel
Seals	NBR
Working temperatures	- 25 °C to + 125 °C
Surface treatment	MATE 500 (CrIII)
Series Interchange	MARKET

Applications



Pressure Drop

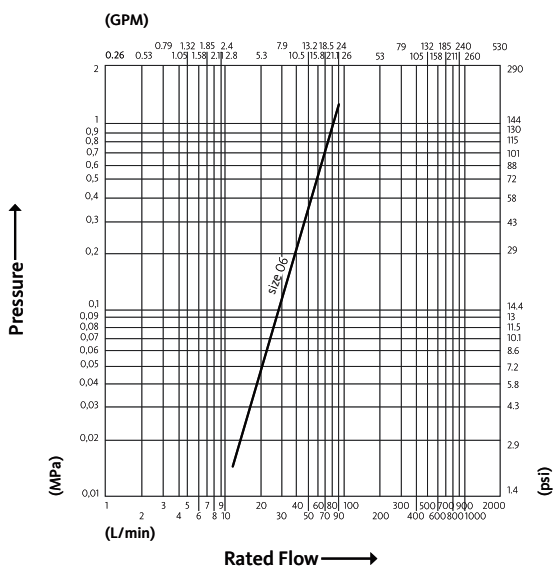

Test performed according to ISO 18869

Valve Type	Flat
Connection	Screw to Connect
Disconnection	Unscrew to Disconnect
Connection Under Pressure	Not Allowed



VA

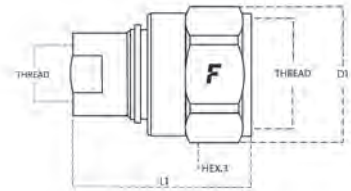

Size		Thread details			FEMALE						
mm	inch	Thread Type	Standard	Thread	Part Number	L (L1 + Thread)		D1		HEX1	
						mm	inch	mm	inch	mm	inch
10	3/8"	0/ METRIC	ISO 6149-1	M18x1.5 FEMALE ORB	VAN0/1815 F	60	2.36	44	1.73	32	1.26

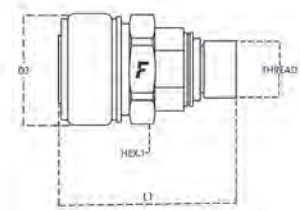

Size		Thread details			MALE								
mm	inch	Thread Type	Standard	Thread	Part Number	L (L1 + Thread)		D1		D3		HEX1	
						mm	inch	mm	inch	mm	inch	mm	inch
10	3/8"	09/ METRIC	ISO 8434-1-L	M18x1.5 MALE BULKHEAD 12L	VA 9/1815 M	53	2.09	36	1.42	36	1.42	32	1.26
10	3/8"	05/ METRIC	ISO 8434-1-L	M22x1.5 MALE BULKHEAD 15L	VA 5/2215 M	59	2.32	36	1.42	36	1.42	32	1.26

VA Accessories and Spares

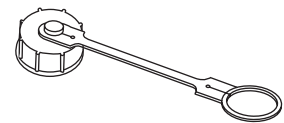

PVC dust protections

page 243

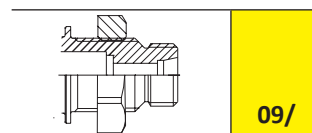
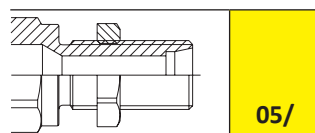
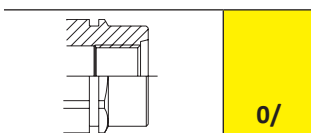

VF

Couplings for braking systems, ISO 5676 interchange.

Flat face couplings designed to connect the braking circuit of trailers to the hydraulic circuit of agricultural machines. ISO 5676 interchange. Some special versions equipped with an additional safety sleeve (VFS) or with an hydraulic lock (VFB) to prevent accidental disconnections are available in the range.



Technical Specifications

dash	Size		Working Pressure (MPa)	Flow Rate (l/min)	Spillage (ml)	Force to Connect (N)	Burst pressure (MPa)		
	mm	inch					Male	Female	Male + Female
06	10	3/8"	15*	40	0.05	100	90	25	75

* Only male connected.

Material	Steel
Seals	NBR
Working temperatures	- 25 °C to + 125 °C
Surface treatment	MATE 500 (CrIII)
Series Interchange	ISO 5676

Applications



Pressure Drop

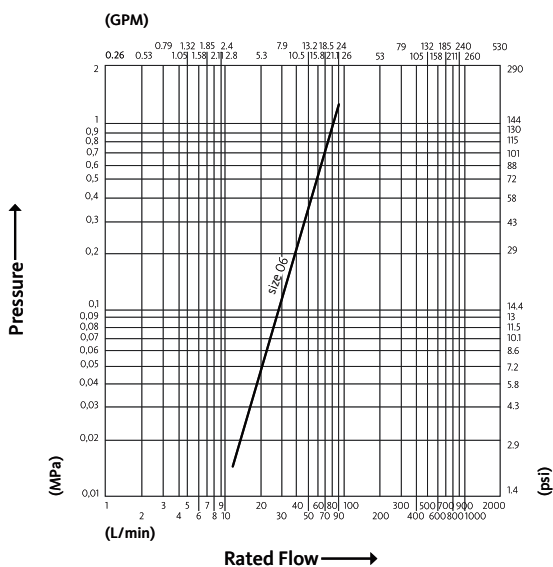

Test performed according to ISO 18869

Valve Type	Flat
Connection	Sleeve Retraction
Disconnection	Sleeve Retraction
Connection Under Pressure	Not Allowed



VF

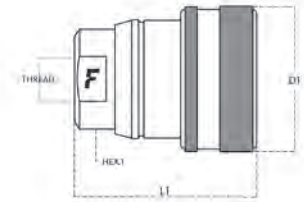

Size		Thread details			FEMALE						
mm	inch	Thread Type	Standard	Thread	Part Number	L (L1 + Thread)		D1		HEX1	
						mm	inch	mm	inch	mm	inch
10	3/8"	F BSPP	ISO 1179-1	BSPP 3/8" FEMALE	VFS 38 GAS F	55	2.17	44	1.73	27	1.06
10	3/8"	F METRIC	ISO 9974-1	M18x1.5 FEMALE	VFS 1815 F	55	2.17	44	1.73	27	1.06
10	3/8"	F METRIC	ISO 9974-1	M18x1.5 FEMALE	VF 1815 F	55	2.17	44	1.73	27	1.06
10	3/8"	F BSPP	ISO 1179-1	BSPP 3/8" FEMALE	VF 38 GAS F	55	2.17	44	1.73	27	1.06
10	3/8"	O/ BSPP	BS 5380	BSPP 1/2 FEMALE ORB	VF O/12 GAS F	59	2.32	44	1.73	27	1.06
10	3/8"	F BSPP	ISO 1179-1	BSPP 3/8" FEMALE	VFB 38 GAS F	84	3.31	44	1.73	27	1.06
10	3/8"	F BSPP	ISO 1179-1	BSPP 1/2" FEMALE	VFB 12 GAS F	84	3.31	44	1.73	27	1.06
10	3/8"	O/ METRIC	ISO 6149-1	M18x1.5 FEMALE ORB	VFB 1815 F	83.7	3.30	44.2	1.74	27	1.06

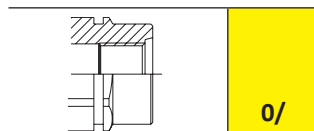
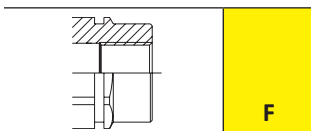

VF

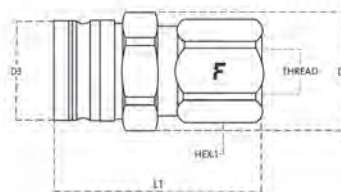

Size		Thread details			MALE								
mm	inch	Thread Type	Standard	Thread	Part Number	L (L1 + Thread)		D1		D3		HEX1	
						mm	inch	mm	inch	mm	inch	mm	inch
10	3/8"	07/ METRIC	ISO 8434-1-L	M18x1.5 MALE BULKHEAD SHORT 12L	VF7/1815 M T	53	2.09	35	1.38	29	1.14	32	1.26
10	3/8"	07/ METRIC	ISO 8434-1-L	M18x1.5 MALE BULKHEAD SHORT 12L	VF 7/1815 M	53	2.09	35	1.38	29	1.14	32	1.26
10	3/8"	02/ METRIC	ISO 8434-1-L	M18x1.5 MALE 12L	VF9/1815 M T	54	2.13	35	1.38	29	1.14	32	1.26
10	3/8"	02/ METRIC	ISO 8434-1-L	M16x1.5 MALE 10L	VF9/1615 M T	54	2.13	35	1.38	29	1.14	32	1.26
10	3/8"	02/ METRIC	ISO 8434-1-L	M18x1.5 MALE 12L	VF9/1815 M TD	54	2.13	35	1.38	29	1.14	32	1.26
10	3/8"	09/ METRIC	ISO 8434-1-L	M18x1.5 MALE 12L	VF 9/1815 M	54	2.13	35	1.38	29	1.14	32	1.26
10	3/8"	09/ METRIC	ISO 8434-1-L	M16x1.5 MALE 10L	VF 9/1615 M	54	2.13	35	1.38	29	1.14	32	1.26
10	3/8"	08/ METRIC	ISO 8434-1-S	M20x1.5 MALE BULKHEAD SHORT 12S	VF 8/2015 M	54	2.13	35	1.38	29	1.14	32	1.26
10	3/8"	01/ METRIC	ISO 6149-2	M18x1.5 MALE	VF 1/1815 M T	57	2.24	35	1.38	29	1.14	32	1.26
10	3/8"	05/ METRIC	ISO 8434-1-L	M22x1.5 MALE BULKHEAD 15L	VF 5/2215 M T	59	2.32	35	1.38	29	1.14	32	1.26
10	3/8"	05/ METRIC	ISO 8434-1-L	M22x1.5 MALE BULKHEAD 15L	VF 5/2215 M	59	2.32	35	1.38	29	1.14	32	1.26
10	3/8"	01/ BSPP	ISO 1179-3	1/2" BSPP MALE	VF 1/12 GAS M	59	2.32	35	1.38	29	1.14	32	1.26
10	3/8"	17/ SAE	ISO 8434-3	11/16"-16 UN MALE ORFS	VFF17/38S M	60	2.36	35	1.38	29	1.14	32	1.26
10	3/8"	14/ SAE	ISO 8434-2	7/8"-14 UNF MALE BULKHEAD JIC	VF 14/58S M	64	2.52	35	1.38	29	1.14	32	1.26
10	3/8"	F BSPP	ISO 1179-1	BSPP 1/2" FEMALE	VF 12 GAS M	67	2.64	35	1.38	29	1.14	32	1.26
10	3/8"	04/ BSPP	ISO 8434-6	BSPP 3/8 MALE BULKHEAD	VF4/12GAS M T	74	2.91	35	1.38	29	1.14	32	1.26
10	3/8"	12/ SAE	ISO 8434-3	13/16"-16 UN MALE BULKHEAD ORFS	VF 12/12S M T	74	2.91	35	1.38	29	1.14	32	1.26
10	3/8"	04/ BSPP	ISO 8434-6	BSPP 3/8 MALE BULKHEAD	VF 4/38 GAS M T	75	2.95	35	1.38	29	1.14	32	1.26

NOTE: The part numbers ending with "T" are provided with caps.

VF Accessories and Spares

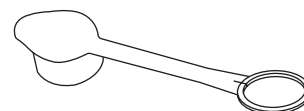

PVC dust protections

page 243

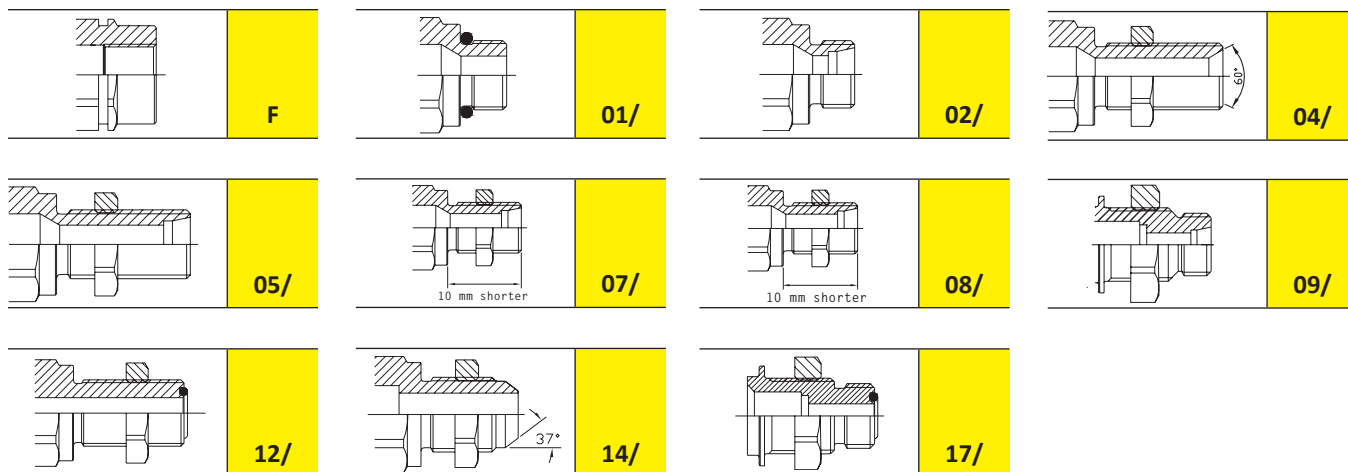

Power Beyond

Full set of flat face couplings for Power Beyond rear attachments.
 Faster offer for Power Beyond covers all ports composing the Power Beyond configuration:

Load Signal Port	Drain Port
Return Port	Pressure Port

Sizes in accordance with class 1 to 3 of ISO 17567 standard.

- Class 1** – Up to 45 l/min
- Class 2** – 45 to 74 l/min
- Class 3** – 74 to 100 l/min
- Class 4** – 100 to 220 l/min

Faster couplings range for Power Beyond applications

Flow Class 1
Up to 45 l/min

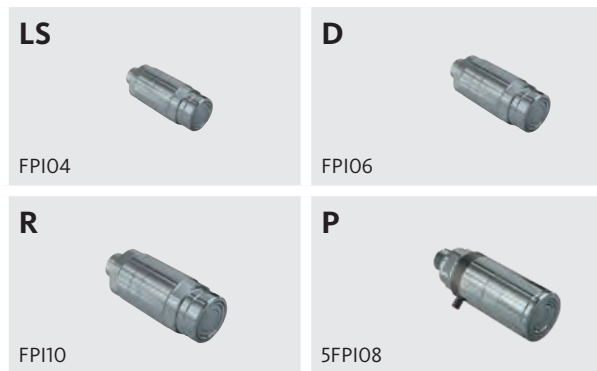

Flow Class 2
45 to 74 l/min

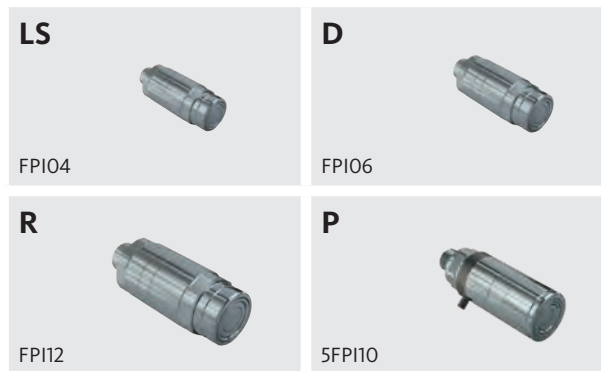

Flow Class 3
74 to 100 l/min

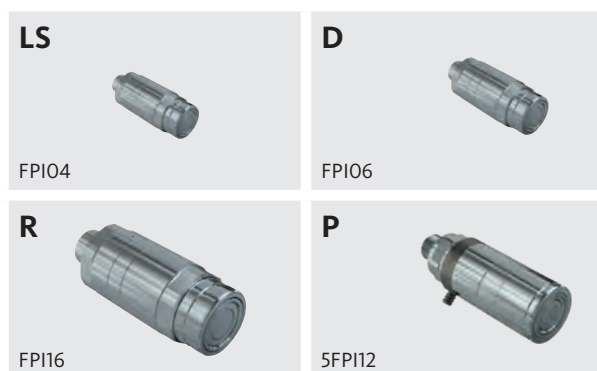

Flow Class 4
100 to 220 l/min

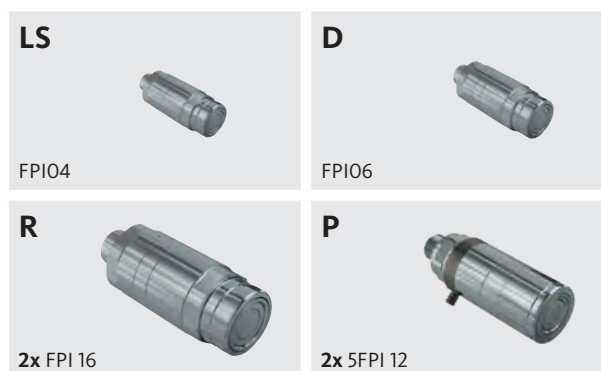



5FPI

Flat Face Female couplings for Power Beyond applications, as specified by ISO 17567.

Female Couplings specifically designed for Power Beyond applications, interchangeable according to ISO 16028. Can be connected and disconnected under residual pressure. Equipped with oil collecting port for clean oil.



Applications



Pressure Drop

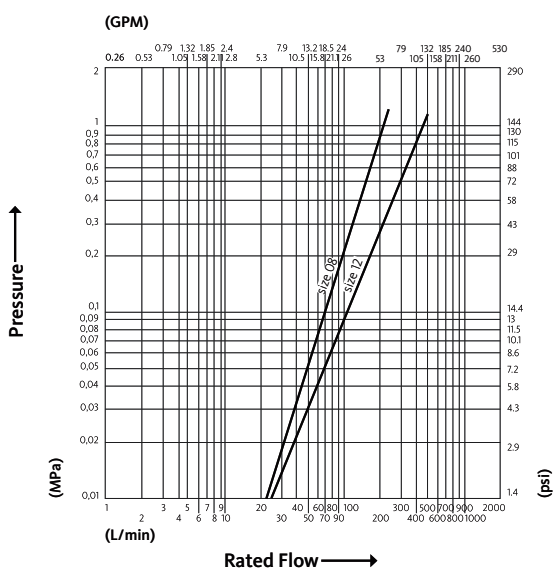

Test performed according to ISO 18869

Technical Specifications

dash	Size		Working Pressure (MPa)	Flow Rate (l/min)	Spillage (ml)	Force to Connect (N)	Burst pressure (MPa)		
	mm	inch					Male	Female	Male + Female
08	12.5	1/2"	25	92	0.01	300	100	100	100
10	16	5/8"	25	115	0.1	360	100	100	100
12	20	3/4"	25	152	0.03	345	100	100	100

Material	Steel
Seals	NBR; PUR
Working temperatures	- 25 °C to + 100 °C
Surface treatment	MATE 500 (CrIII)
Series Interchange	ISO 16028 - ISO 17567

Valve Type	Flat
Connection	Push to Connect
Disconnection	Pull to Disconnect
Connection Under Pressure	Allowed Male Half up to W.P. and residual in Female Half in 5FPI



5FPI

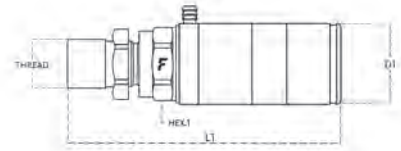

Size		Thread details			FEMALE						
mm	inch	Thread Type	Standard	Thread	Part Number	L (L1 + Thread)		D1		HEX1	
						mm	inch	mm	inch	mm	inch
12.5	1/2"	01/ METRIC	ISO 6149-2	M27x2 MALE	5FPI081/272F A	133.9	5.27	46	1.81	38	1.5
16	5/8"	0/ BSPP	BS 5380	3/4 BSP FEMALE ORB	5FPI10 34GAS F	130	7.44	38	1.5	58	2.28
16	5/8"	08/ METRIC	ISO 8434-1-S	M36X2 MALE BULKHEAD SHORT 25S	5FPI108/3620 FD	130	7.44	38	1.5	58	2.28
20	3/4"	01/ METRIC	ISO 6149-2	M27x2 MALE	5FPI121/272F A	163.6	6.44	58	2.28	38	1.5

5FPI Accessories

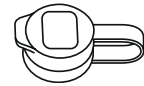

PVC dust protections

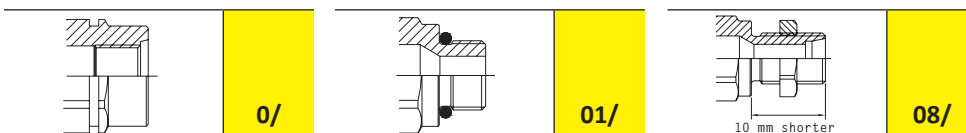

FPI



Flat Face Female couplings for Power Beyond applications, as specified by ISO 17567.

Female Couplings specifically designed for Power Beyond applications, interchangeable according to ISO 16028. Connection under pressure allowed. Breakaway function.



Applications



Pressure Drop

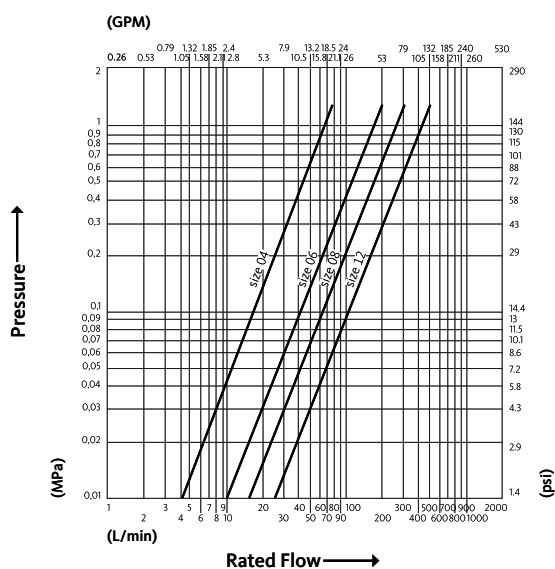

Test performed according to ISO 18869

Technical Specifications

dash	Size mm	inch	Working Pressure (MPa)	Flow Rate (l/min)	Spillage (ml)	Force to Connect (N)	Burst pressure (MPa)		
							Male	Female	Male + Female
04	6.3	1/4"	25	25	0.006	112	100	100	100
06	10	3/8"	25	47	0.01	190	100	100	100
08	12.5	1/2"	25	92	0.01	300	100	100	100
10	16	5/8"	25	125	0.02	330	100	100	100
12	20	3/4"	25	152	0.03	345	100	100	100
16	25	1"	25	210	0.03	410	100	100	100

Material	Steel
Seals	NBR; PUR
Working temperatures	- 25 °C to + 100 °C
Surface treatment	MATE 500 (CrIII)
Series Interchange	ISO 16028 - ISO 17567

Valve Type	Flat
Connection	Push to Connect
Disconnection	Pull to Disconnect
Connection Under Pressure	Allowed Male Half up to W.P. and residual in Female Half in 5FPI



FPI

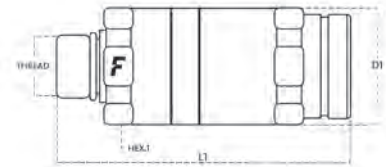

Size		Thread details			FEMALE							
mm	inch	Thread Type	Standard	Thread	Part Number	L (L1 + Thread)		D1		HEX1		
						mm	inch	mm	inch	mm	inch	
6.3	1/4"	01/ METRIC	ISO 6149-2	M14x1.5 MALE	FPI041/1415 F	89.7	3.53	32	1.26	30	1.18	
6.3	1/4"	F BSPP	ISO 1179-1	BSPP 1/4 FEMALE	FPI04 14GAS F	90	3.54	32	1.26	30	1.18	
6.3	1/4"	05/ METRIC	ISO 8434-1-L	M14x1.5 MALE BULKHEAD	FPI045/1415 F	111.8	4.40	32	1.26	30	1.18	
10	3/8"	F BSPP	ISO 1179-1	BSPP 1/2 FEMALE	FPI06 12GAS F	101.7	4.00	36	1.42	34	1.34	
12.5	1/2"	08/ METRIC	ISO 8434-1-S	M22x1.5 MALE BULKHEAD SHORT	FPI081/2215 F	111	4.37	45	1.77	38	1.50	
16	5/8"	01/ METRIC	ISO 6149-2	M27x2 MALE	FPI101/2720 F	130	5.12	48	1.89	51	2.01	
20	3/4"	01/ METRIC	ISO 6149-2	M27x2 MALE	FPI121/272 F	130.1	5.12	51	2.01	48	1.89	
25	1"	F BSPP	ISO 1179-1	BSPP 3/4" FEMALE	FPI16 34GAS F	140	5.51	64	2.52	60	2.36	

FPI Accessories

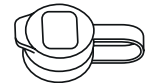

PVC dust protections

page 243

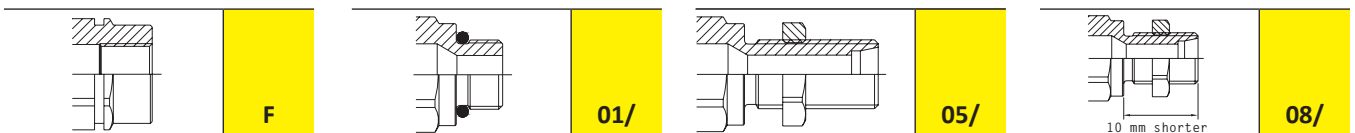

Flat Face

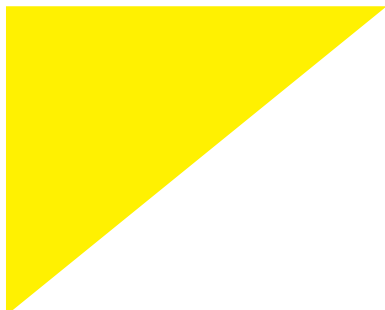

Couplings equipped with flat face valve to prevent spillage, therefore easier to clean.

FFH	page 121
FSH	page 129
3FFH	page 131
2FSI - FFI	page 135
2FFI brass	page 137
2FFI stainless steel	page 139
FFC	page 143
OGF	page 145
FHV	page 147
FHV IP	page 153
FHV K	page 155
Couplings Accessories	page 242



FFH

Flat face couplings, ISO 16028 interchange, 35 MPa series.

Flat face couplings with real maximum working pressure of 35 MPa and Zinc-Nickel plating. Flat valve shut-off system contributes to prevent contamination and spillage. ISO 16028 interchange.



Applications



Pressure Drop

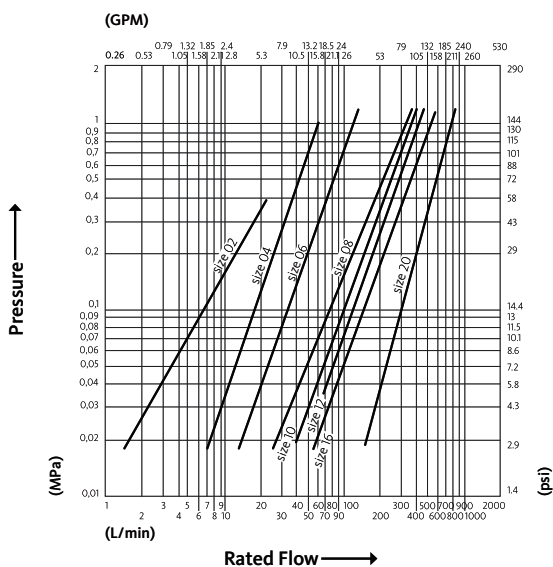

Test performed according to ISO 18869

Technical Specifications

dash	Size mm	inch	Working Pressure (MPa)	Flow Rate (l/min)	Spillage (ml)	Force to Connect (N)	Burst pressure (MPa)		
							Male	Female	Male + Female
02*	3.2*	1/8"*	35	12	0.001	105	170	140	180
04	6.3	1/4"	35	25	0.006	110	170	140	180
06	10	3/8"	35	50	0.008	150	170	140	170
08	12.5	1/2"	35	110	0.01	210	140	140	170
10	16	5/8"	35	125	0.02	205	140	140	140
12	20	3/4"	35	160	0.02	215	140	140	140
16	25	1"	35	230	0.03	280	140	140	170
20	31.5	1-1/4"	35	390	0.03	350	105	105	140

* FFH02 has surface treatment in MATE 500 (CRIII) and is not interchangeable according to ISO 16028.

Material	Steel	Valve Type	Flat
Seals	NBR; PUR	Connection	Push to Connect
Working temperatures	- 25 °C to + 100 °C	Disconnection	Sleeve Retraction
Surface treatment	MATE 1000 (Zn-Ni)	Connection Under Pressure	Not Allowed
Series Interchange	ISO 16028*		

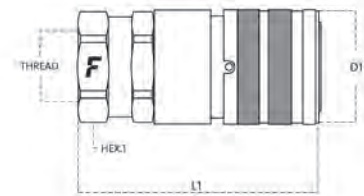

FFH

Size		Thread details			FEMALE						
mm	inch	Thread Type	Standard	Thread	Part Number	L (L1 + Thread)		D1		HEX1	
						mm	inch	mm	inch	mm	inch
3.2	1/8"	13/ SAE	ISO 8434-2	7/16"-20 UNF MALE JIC	FFH02-13/14S F	60.1	2.37	20	0.79	18	0.71
3.2	1/8"	F BSPP	ISO 1179-1	BSPP 1/8" FEMALE	FFH02 18GAS F	46.1	1.81	20	0.79	18	0.71
3.2	1/8"	F BSPP	ISO 1179-1	BSPP 1/4" FEMALE	FFH02 14GAS F	51.3	2.02	20	0.79	18	0.71
6.3	1/4"	0/ SAE	ISO 11926-1	7/16"-20 UNF FEMALE ORB	FFH04 14SAE F	59	2.32	27	1.06	24	0.94
6.3	1/4"	F JPT	UNI EN 10226-2	RC 1/4 FEMALE (JPT)	FFH04 14JPT F	58.9	2.32	27	1.06	24	0.94
6.3	1/4"	07/ METRIC	ISO 8434-1-L	M16x1.5 MALE BULKHEAD SHORT 10L	FFH04-7/1615 F	82.4	3.24	27	1.06	24	0.94
6.3	1/4"	06/ METRIC	ISO 8434-1-S	M16x1.5 MALE BULKHEAD 8S	FFH04-6/1615 F	75.5	2.97	27	1.06	24	0.94
6.3	1/4"	05/ METRIC	ISO 8434-1-L	M16x1.5 MALE BULKHEAD 10L	FFH04-5/1615 F	92.4	3.64	27	1.06	24	0.94
6.3	1/4"	03/ METRIC	ISO 8434-1-S	M16x1.5 MALE 8S	FFH04-3/1615 F	69.4	2.73	27	1.06	24	0.94
6.3	1/4"	02/ METRIC	ISO 8434-1-L	M16x1.5 MALE 10L	FFH04-2/1615 F	68.4	2.69	27	1.06	24	0.94
6.3	1/4"	02/ METRIC	ISO 8434-1-L	M14x1.5 MALE 8L	FFH04-2/1415 F	67.4	2.65	27	1.06	24	0.94
6.3	1/4"	14/ SAE	ISO 8434-2	9/16"-18 UNF MALE BULKHEAD JIC	FFH04-14/38S F	89.9	3.54	27	1.06	24	0.94
6.3	1/4"	13/ SAE	ISO 8434-2	9/16"-18 UNF MALE JIC	FFH04-13/38S F	71.5	2.81	27	1.06	24	0.94
6.3	1/4"	12/ SAE	ISO 8434-3	11/16"-16 UN MALE BULKHEAD ORFS	FFH04-12/38S F	91.4	3.6	27	1.06	24	0.94
6.3	1/4"	0/ METRIC	ISO 6149-1	M16x1.5 FEMALE ORB	FFH04-0/1615 F	61.1	2.41	27	1.06	24	0.94
6.3	1/4"	0/ SAE	ISO 11926-1	9/16"-18 UNF FEMALE ORB	FFH04 38SAE F	59.6	2.35	27	1.06	24	0.94
6.3	1/4"	F NPTF	ANSI B1.20.3	NPTF 1/4" FEMALE	FFH04 14NPT F	58.9	2.32	27	1.06	24	0.94
6.3	1/4"	F BSPP	ISO 1179-1	BSPP 1/4" FEMALE	FFH04 14GAS F	58.9	2.32	27	1.06	24	0.94
10	3/8"	F JPT	UNI EN 10226-2	RC 3/8 FEMALE (JPT)	FFH06 38JPT F	74.9	2.95	30	1.18	27	1.06
10	3/8"	F BSPP	ISO 1179-1	BSPP 3/8" FEMALE	FFH06 38GAS FB	75	2.95	30	1.18	27	1.06
10	3/8"	F JPT	UNI EN 10226-2	RC 1/2 FEMALE (JPT)	FFH06 12JPT F	78.4	3.09	30	1.18	27	1.06
10	3/8"	07/ METRIC	ISO 8434-1-L	M22x1.5 MALE BULKHEAD SHORT 15L	FFH06-7/2215 F	97.9	3.85	30	1.18	27	1.06
10	3/8"	07/ METRIC	ISO 8434-1-L	M18x1.5 MALE BULKHEAD SHORT 12L	FFH06-7/1815 F	95.9	3.78	30	1.18	27	1.06
10	3/8"	07/ METRIC	ISO 8434-1-L	M16x1.5 MALE BULKHEAD SHORT 10L	FFH06-7/1615 F	94.9	3.74	30	1.18	27	1.06
10	3/8"	06/ METRIC	ISO 8434-1-S	M20x1.5 MALE BULKHEAD 12S	FFH06-6/2015 F	107.9	4.25	30	1.18	27	1.06
10	3/8"	05/ METRIC	ISO 8434-1-L	M22x1.5 MALE BULKHEAD 15L	FFH06-5/2215 F	107.9	4.25	30	1.18	27	1.06
10	3/8"	05/ METRIC	ISO 8434-1-L	M18x1.5 MALE BULKHEAD 12L	FFH06-5/1815 F	105.9	4.17	30	1.18	27	1.06
10	3/8"	03/ METRIC	ISO 8434-1-S	M20x1.5 MALE 12S	FFH06-3/2015 F	80.9	3.19	30	1.18	27	1.06
10	3/8"	02/ METRIC	ISO 8434-1-L	M18x1.5 MALE 12L	FFH06-2/1815 F	80.9	3.19	30	1.18	27	1.06
10	3/8"	02/ METRIC	ISO 8434-1-L	M16x1.5 MALE 10L	FFH06-2/1615 F	80.9	3.19	30	1.18	27	1.06
10	3/8"	02/ METRIC	ISO 8434-1-L	M14x1.5 MALE 8L	FFH06-2/1415 F	79.9	3.15	30	1.18	27	1.06
10	3/8"	14/ SAE	ISO 8434-2	3/4"-16 UN MALE BULKHEAD JIC	FFH06-14/12S F	106.5	4.19	30	1.18	27	1.06
10	3/8"	12/ SAE	ISO 8434-3	13/16"-16 UN MALE BULKHEAD ORFS	FFH06-12/12S F	106	4.17	30	1.18	27	1.06
10	3/8"	01/ SAE	ISO 11926-3	9/16"-18 UNF MALE	FFH06-1/38S F	79.9	3.15	30	1.18	27	1.06
10	3/8"	01/ SAE	ISO 11926-3	3/4"-16 UNF MALE	FFH06-1/12S F	80.7	3.18	30	1.18	27	1.06
10	3/8"	F BSPP	ISO 1179-1	BSPP 3/8" FEMALE	FFH06 38GAS FV	97.9	3.85	30	1.18	27	1.06
10	3/8"	0/ SAE	ISO 11926-1	3/4"-16 UNF FEMALE ORB	FFH06 12SAE F	76.9	3.03	30	1.18	27	1.06
10	3/8"	F NPTF	ANSI B1.20.3	NPTF 1/2" FEMALE	FFH06 12NPT F	79.4	3.13	30	1.18	27	1.06
10	3/8"	F NPTF	ANSI B1.20.3	NPTF 3/8" FEMALE	FFH06 38NPT F	75	2.95	30	1.18	27	1.06
10	3/8"	02/ METRIC	ISO 8434-1-L	M22x1.5 MALE 15L	FFH06-2/2215 F	81.9	3.22	30	1.18	27	1.06
10	3/8"	F BSPP	ISO 1179-1	BSPP 3/8" FEMALE	FFH06 38GAS F	75	2.95	30	1.18	27	1.06
10	3/8"	F BSPP	ISO 1179-1	BSPP 1/2" FEMALE	FFH06 12GAS F	79.4	3.13	30	1.18	27	1.06
12.5	1/2"	02/ METRIC	ISO 8434-1-L	M26x1.5 MALE 18L	FFH08-2/2615 F	83.3	3.28	38	1.5	34	1.34
12.5	1/2"	F JPT	UNI EN 10226-2	RC 1/2 FEMALE (JPT)	FFH08 12JPT F	81.3	3.2	38	1.5	34	1.34
12.5	1/2"	07/ METRIC	ISO 8434-1-L	M22x1.5 MALE BULKHEAD SHORT 15L	FFH08-7/2215 F	99.3	3.91	38	1.5	34	1.34
12.5	1/2"	05/ METRIC	ISO 8434-1-L	M18x1.5 MALE BULKHEAD 12L	FFH08-5/1815 F	107.3	4.22	38	1.5	34	1.34

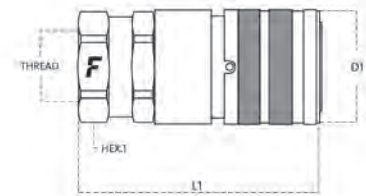

FFH

Size		Thread details			FEMALE						
mm	inch	Thread Type	Standard	Thread	Part Number	L (L1 + Thread)		D1		HEX1	
						mm	inch	mm	inch	mm	inch
12.5	1/2"	02/ METRIC	ISO 8434-1-L	M22x1.5 MALE 15L	FFH08-2/2215 F	83.3	3.28	38	1.5	34	1.34
12.5	1/2"	02/ METRIC	ISO 8434-1-L	M18x1.5 MALE 12L	FFH08-2/1815 F	82.3	3.24	38	1.5	34	1.34
12.5	1/2"	14/ SAE	ISO 8434-2	7/8"-14 UNF MALE BULKHEAD JIC	FFH08-14/58S F	111.4	4.39	38	1.5	34	1.34
12.5	1/2"	14/ SAE	ISO 8434-2	1-1/16"-12 UN MALE BULKHEAD JIC	FFH08-14/34S F	115.7	4.56	38	1.5	34	1.34
12.5	1/2"	14/ SAE	ISO 8434-2	3/4"-16 UN MALE BULKHEAD JIC	FFH08-14/12S F	107.9	4.25	38	1.5	34	1.34
12.5	1/2"	13/ SAE	ISO 8434-2	7/8"-14 UNF MALE JIC	FFH08-13/58S F	90.6	3.57	38	1.5	34	1.34
12.5	1/2"	12/ SAE	ISO 8434-3	1"-14 UNS MALE BULKHEAD ORFS	FFH08-12/58S F	111.8	4.4	38	1.5	34	1.34
12.5	1/2"	12/ SAE	ISO 8434-3	1-3/16"-12 UN MALE BULKHEAD ORFS	FFH08-12/34S F	112.8	4.44	38	1.5	36	1.42
12.5	1/2"	12/ SAE	ISO 8434-3	13/16"-16 UN MALE BULKHEAD ORFS	FFH08-12/12S F	107.8	4.24	38	1.5	34	1.34
12.5	1/2"	01/ SAE	ISO 11926-3	3/4"-16 UNF MALE	FFH08-1/12S F	82.4	3.24	38	1.5	34	1.34
12.5	1/2"	F NPTF	ANSI B1.20.3	NPTF 3/4" FEMALE	FFH08 34NPT F	81.3	3.2	38	1.5	34	1.34
12.5	1/2"	0/ SAE	ISO 11926-1	3/4"-16 UNF FEMALE ORB	FFH08 12SAE F	81.3	3.2	38	1.5	34	1.34
12.5	1/2"	F BSPP	ISO 1179-1	BSPP 1/2" FEMALE	FFH08 12GAS FV	81.3	3.2	38	1.5	34	1.34
12.5	1/2"	0/ SAE	ISO 11926-1	7/8"-14 UNF FEMALE ORB	FFH08 58SAE F	81.3	3.2	38	1.5	34	1.34
12.5	1/2"	0/ SAE	ISO 11926-1	1-1/16"-12 UN FEMALE ORB	FFH08 34SAE F	86.8	3.42	38	1.5	34	1.34
12.5	1/2"	F NPTF	ANSI B1.20.3	NPTF 1/2" FEMALE	FFH08 12NPT F	81.3	3.2	38	1.5	34	1.34
12.5	1/2"	F BSPP	ISO 1179-1	BSPP 3/4" FEMALE	FFH08 34GAS F	84.8	3.34	38	1.5	34	1.34
12.5	1/2"	F BSPP	ISO 1179-1	BSPP 1/2" FEMALE	FFH08 12GAS F	81.3	3.2	38	1.5	34	1.34
16	5/8"	06/ METRIC	ISO 8434-1-S	M24x1.5 MALE BULKHEAD 16S	FFH10-6/2415 F	120.3	4.74	42	1.65	38	1.5
16	5/8"	05/ METRIC	ISO 8434-1-L	M26x1.5 MALE BULKHEAD 18L	FFH10-5/2615 F	120.3	4.74	42	1.65	38	1.5
16	5/8"	03/ METRIC	ISO 8434-1-S	M24x1.5 MALE 16S	FFH10-3/2415 F	94.3	3.71	42	1.65	38	1.5
16	5/8"	02/ METRIC	ISO 8434-1-L	M26x1.5 MALE 18L	FFH10-2/2615 F	92.3	3.63	42	1.65	38	1.5
16	5/8"	01/ SAE	ISO 11926-3	7/8"-14 UNF MALE	FFH10-1/58S F	93	3.66	42	1.65	38	1.5
16	5/8"	01/ SAE	ISO 11926-3	1-1/16"-12 UN MALE	FFH10-1/34S F	95.4	3.76	42	1.65	38	1.5
16	5/8"	F BSPP	ISO 1179-1	BSPP 5/8" FEMALE	FFH10 58GAS F	91.1	3.59	42	1.65	38	1.5
16	5/8"	0/ SAE	ISO 11926-1	1-1/16"-12 UN FEMALE ORB	FFH10 34SAE F	95.1	3.74	42	1.65	38	1.5
16	5/8"	F NPTF	ANSI B1.20.3	NPTF 3/4" FEMALE	FFH10 34NPT F	92.1	3.63	42	1.65	38	1.5
16	5/8"	F BSPP	ISO 1179-1	BSPP 3/4" FEMALE	FFH10 34GAS F	92.1	3.63	42	1.65	38	1.5
20	3/4"	F JPT	UNI EN 10226-2	RC 3/4 FEMALE (JPT)	FFH12 34JPT F	100.3	3.95	48	1.89	42	1.65
20	3/4"	06/ METRIC	ISO 8434-1-S	M36x2 MALE BULKHEAD 25S	FFH12-6/3620 F	138.9	5.47	48	1.89	42	1.65
20	3/4"	06/ METRIC	ISO 8434-1-S	M30x2 MALE BULKHEAD 20S	FFH12-6/3020 F	136.1	5.36	48	1.89	42	1.65
20	3/4"	14/ SAE	ISO 8434-2	1-1/16"-12 UN MALE BULKHEAD JIC	FFH12-14/34S F	136.3	5.37	48	1.89	42	1.65
20	3/4"	12/ SAE	ISO 8434-3	1-3/16"-12 UN MALE BULKHEAD ORFS	FFH12-12/34S F	133.4	5.25	48	1.89	42	1.65
20	3/4"	12/ SAE	ISO 8434-3	1-7/16"-12 UN MALE BULKHEAD ORFS	FFH12-12/1S F	133.9	5.27	48	1.89	42	1.65
20	3/4"	01/ SAE	ISO 11926-3	1-1/16"-12 UN MALE	FFH12-1/34S F	107.6	4.24	48	1.89	42	1.65
20	3/4"	01/ METRIC	ISO 6149-2	M27x2 MALE	FFH12-1/2720 F	113.1	4.45	48	1.89	42	1.65
20	3/4"	0/ METRIC	ISO 6149-1	M33x2 FEMALE ORB	FFH12-0/3320 F	102.6	4.04	48	1.89	42	1.65
20	3/4"	0/ SAE	ISO 11926-1	1-1/16"-12 UN FEMALE ORB	FFH12 34SAE F	104.3	4.11	48	1.89	42	1.65
20	3/4"	F NPTF	ANSI B1.20.3	NPTF 3/4" FEMALE	FFH12 34NPT F	100.3	3.95	48	1.89	42	1.65
20	3/4"	0/ SAE	ISO 11926-1	1-5/16"-12 UN FEMALE ORB	FFH12 1SAE F	104.3	4.11	48	1.89	42	1.65
20	3/4"	F NPTF	ANSI B1.20.3	NPTF 1" FEMALE	FFH12 1NPT F	104.3	4.11	48	1.89	42	1.65
20	3/4"	F BSPP	ISO 1179-1	BSPP 1" FEMALE	FFH12 1GAS F	104.3	4.11	48	1.89	42	1.65
20	3/4"	F BSPP	ISO 1179-1	BSPP 3/4" FEMALE	FFH12 34GAS F	100.3	3.95	48	1.89	42	1.65
25	1"	06/ METRIC	ISO 8434-1-S	M36x2 MALE BULKHEAD 25S	FFH16-6/3620 F	141	5.55	55	2.17	50	1.97
25	1"	03/ METRIC	ISO 8434-1-S	M36x2 MALE 25S	FFH16-3/3620 F	112	4.41	55	2.17	50	1.97
25	1"	01/ METRIC	ISO 6149-2	M30x2 MALE	FFH16-1/3020 F	121.5	4.78	55	2.17	50	1.97

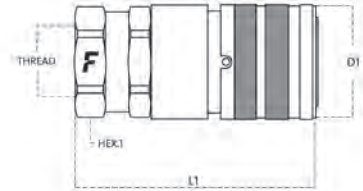

FFH

Size		Thread details			FEMALE							
mm	inch	Thread Type	Standard	Thread	Part Number	L (L1 + Thread)		D1		HEX1		
						mm	inch	mm	inch	mm	inch	
25	1"	O/ METRIC	ISO 6149-1	M33x2 FEMALE ORB	FFH16-0/3320 F	103	4.06	55	2.17	50	1.97	
25	1"	O/ SAE	ISO 11926-1	1-5/16"-12 UN FEMALE ORB	FFH16 1SAE F	100.5	3.96	55	2.17	50	1.97	
25	1"	F NPTF	ANSI B1.20.3	NPTF 1" FEMALE	FFH16 1NPT F	100.5	3.96	55	2.17	50	1.97	
25	1"	F NPTF	ANSI B1.20.3	NPTF 1-1/4" FEMALE	FFH16 114NPT F	100.5	3.96	55	2.17	50	1.97	
25	1"	F BSPP	ISO 1179-1	BSPP 1-1/2" FEMALE	FFH16 112GAS F	105.3	4.15	55	2.17	55	2.17	
25	1"	F BSPP	ISO 1179-1	BSPP 1-1/4" FEMALE	FFH16 114GAS F	103	4.06	55	2.17	50	1.97	
25	1"	F BSPP	ISO 1179-1	BSPP 1" FEMALE	FFH16 1GAS F	100.5	3.96	55	2.17	50	1.97	
31.5	1-1/4"	F BSPP	ISO 1179-1	BSPP 1-1/4" FEMALE	FFH20 114GAS F	103.4	4.07	63	2.48	60	2.36	

Part number ending in V have seals in FKM and consequently a Working Temperature of -20°C + 200 °C.

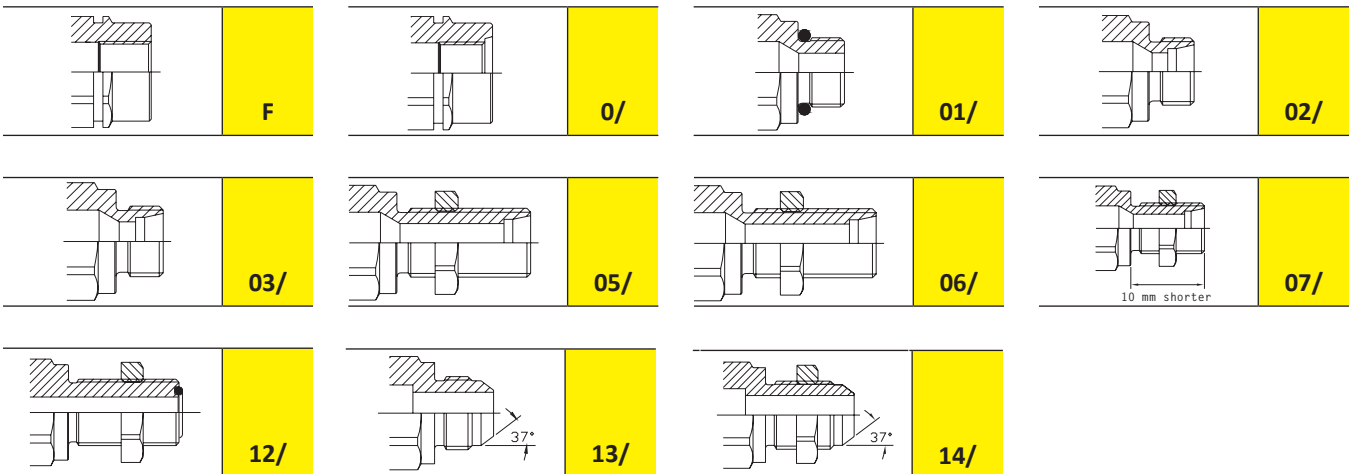

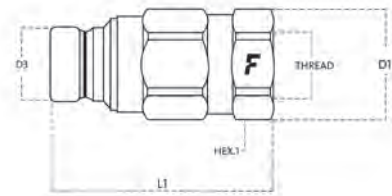

FFH

Size		Thread details			MALE									
mm	inch	Thread Type	Standard	Thread	Part Number	L (L1 + Thread)		D1		D3		HEX1		
						mm	inch	mm	inch	mm	inch	mm	inch	
3.2	1/8"	01/ BSPP	ISO 1179-3	1/4" BSPP MALE	FFH02-21/14G M	51	2.01	21	0.83	11.6	0.46	19	0.75	
3.2	1/8"	01/ SAE	ISO 11926-3	9/16"-18 UNF MALE	FFH02-1/38S M	54	2.13	19	0.75	11.6	0.46	17	0.67	
3.2	1/8"	F BSPP	ISO 1179-1	BSPP 1/8" FEMALE	FFH02 18GAS M	44	1.73	18	0.71	11.6	0.46	16	0.63	
6.3	1/4"	27/ SAE	ISO 8434-3	11/16" – 16 UN	FFH04-27/38S M	50	1.97	26	1.02	16.1	0.63	24	0.94	
6.3	1/4"	0/ SAE	ISO 11926-1	7/16"-20 UNF FEMALE ORB	FFH04 14SAE M	49	1.93	26	1.02	16.1	0.63	24	0.94	
6.3	1/4"	F JPT	UNI EN 10226-2	RC 1/4 FEMALE (JPT)	FFH04 14JPT M	49	1.93	26	1.02	16.1	0.63	24	0.94	
6.3	1/4"	07/ METRIC	ISO 8434-1-L	M14x1.5 MALE BULKHEAD SHORT 8L	FFH04-7/1415 M	63.5	2.5	26	1.02	16.1	0.63	24	0.94	
6.3	1/4"	06/ METRIC	ISO 8434-1-S	M16x1.5 MALE BULKHEAD 8S	FFH04-6/1615 M	75.5	2.97	26	1.02	16.1	0.63	24	0.94	
6.3	1/4"	05/ METRIC	ISO 8434-1-L	M16x1.5 MALE BULKHEAD 10L	FFH04-5/1615 M	74.5	2.93	26	1.02	16.1	0.63	24	0.94	
6.3	1/4"	03/ METRIC	ISO 8434-1-S	M16x1.5 MALE 8S	FFH04-3/1615 M	51.5	2.03	26	1.02	16.1	0.63	24	0.94	
6.3	1/4"	28/ SAE	ISO 8434-2	3/4"-16 UNF FEMALE JIC	FFH04-28/12S M	50	1.97	26	1.02	16.1	0.63	24	0.94	
6.3	1/4"	14/ SAE	ISO 8434-2	9/16"-18 UNF MALE BULKHEAD JIC	FFH04-14/38S M	72	2.83	26	1.02	16.1	0.63	24	0.94	
6.3	1/4"	13/ SAE	ISO 8434-2	9/16"-18 UNF MALE JIC	FFH04-13/38S M	53.6	2.11	26	1.02	16.1	0.63	24	0.94	
6.3	1/4"	12/ SAE	ISO 8434-3	11/16"-16 UN MALE BULKHEAD ORFS	FFH04-12/38S M	73.5	2.89	26	1.02	16.1	0.63	24	0.94	
6.3	1/4"	01/ BSPP	ISO 1179-3	1/4" BSPP MALE	FFH04-1/14G M	52	2.05	26	1.02	16.1	0.63	24	0.94	
6.3	1/4"	0/ SAE	ISO 11926-1	9/16"-18 UNF FEMALE ORB	FFH04 38SAE M	52	2.05	26	1.02	16.1	0.63	24	0.94	
6.3	1/4"	F NPTF	ANSI B1.20.3	NPTF 1/4" FEMALE	FFH04 14NPT M	49	1.93	26	1.02	16.1	0.63	24	0.94	
6.3	1/4"	F BSPP	ISO 1179-1	BSPP 1/4" FEMALE	FFH04 14GAS M	49	1.93	26	1.02	16.1	0.63	24	0.94	
10	3/8"	07/ METRIC	ISO 8434-1-L	M22x1.5 MALE BULKHEAD SHORT 15L	FFH06-7/2215 MT	89.3	3.52	33	1.3	19.7	0.78	30	1.18	
10	3/8"	07/ METRIC	ISO 8434-1-L	M18x1.5 MALE BULKHEAD SHORT 12L	FFH06-7/1815 MT	87.3	3.44	33	1.3	19.7	0.78	30	1.18	
10	3/8"	27/ SAE	ISO 8434-3	11/16" – 16 UN	FFH06-27/38S M	69.3	2.73	33	1.3	19.7	0.78	30	1.18	
10	3/8"	F NPTF	ANSI B1.20.3	NPTF 3/8" FEMALE	FFH06 38NPT MT	68.3	2.69	33	1.3	19.7	0.78	30	1.18	
10	3/8"	F JPT	UNI EN 10226-2	RC 3/8 FEMALE (JPT)	FFH06 38JPT M	68.3	2.69	33	1.3	19.7	0.78	30	1.18	
10	3/8"	F BSPP	ISO 1179-1	BSPP 3/8" FEMALE	FFH06 38GAS MB	68.3	2.69	33	1.3	19.7	0.78	30	1.18	
10	3/8"	F JPT	UNI EN 10226-2	RC 1/2 FEMALE (JPT)	FFH06 12JPT M	71.8	2.83	33	1.3	19.7	0.78	30	1.18	
10	3/8"	07/ METRIC	ISO 8434-1-L	M22x1.5 MALE BULKHEAD SHORT 15L	FFH06-7/2215 M	89.3	3.52	33	1.3	19.7	0.78	30	1.18	
10	3/8"	07/ METRIC	ISO 8434-1-L	M18x1.5 MALE BULKHEAD SHORT 12L	FFH06-7/1815 M	87.3	3.44	33	1.3	19.7	0.78	30	1.18	
10	3/8"	06/ METRIC	ISO 8434-1-S	M20x1.5 MALE BULKHEAD 12S	FFH06-6/2015 M	99.3	3.91	33	1.3	19.7	0.78	30	1.18	
10	3/8"	05/ METRIC	ISO 8434-1-L	M18x1.5 MALE BULKHEAD 12L	FFH06-5/1815 M	97.3	3.83	33	1.3	19.7	0.78	30	1.18	
10	3/8"	03/ METRIC	ISO 8434-1-S	M20x1.5 MALE 12S	FFH06-3/2015 M	73.3	2.89	33	1.3	19.7	0.78	30	1.18	
10	3/8"	01/ BSPP	ISO 1179-3	1/2" BSPP MALE	FFH06-21/12G M	75.3	2.96	33	1.3	19.7	0.78	30	1.18	
10	3/8"	02/ METRIC	ISO 8434-1-L	M22x1.5 MALE 15L	FFH06-2/2215 M	73.3	2.89	33	1.3	19.7	0.78	30	1.18	
10	3/8"	02/ METRIC	ISO 8434-1-L	M18x1.5 MALE 12L	FFH06-2/1815 M	72.3	2.85	33	1.3	19.7	0.78	30	1.18	
10	3/8"	02/ METRIC	ISO 8434-1-L	M16x1.5 MALE 10L	FFH06-2/1615 M	72.3	2.85	33	1.3	19.7	0.78	30	1.18	
10	3/8"	14/ SAE	ISO 8434-2	3/4"-16 UN MALE BULKHEAD JIC	FFH06-14/12S M	97.9	3.85	33	1.3	19.7	0.78	30	1.18	
10	3/8"	12/ SAE	ISO 8434-3	13/16"-16 UN MALE BULKHEAD ORFS	FFH06-12/12S M	98	3.86	33	1.3	19.7	0.78	30	1.18	
10	3/8"	11/ SAE	ISO 8434-3	11/16"-16 UN MALE ORFS	FFH06-11/38S M	72.3	2.85	33	1.3	19.7	0.78	30	1.18	
10	3/8"	11/ SAE	ISO 8434-3	13/16"-16 UN MALE ORFS	FFH06-11/12S M	74	2.91	33	1.3	19.7	0.78	30	1.18	
10	3/8"	01/ SAE	ISO 11926-3	3/4"-16 UNF MALE	FFH06-1/12S M	72.4	2.85	33	1.3	19.7	0.78	30	1.18	
10	3/8"	01/ BSPP	ISO 1179-3	1/2" BSPP MALE	FFH06-1/12G M	75.8	2.98	33	1.3	19.7	0.78	30	1.18	
10	3/8"	F BSPP	ISO 1179-1	BSPP 3/8" FEMALE	FFH06 38GAS MV	68.3	2.69	33	1.3	19.7	0.78	30	1.18	
10	3/8"	0/ SAE	ISO 11926-1	3/4"-16 UNF FEMALE ORB	FFH06 12SAE M	71.8	2.83	33	1.3	19.7	0.78	30	1.18	
10	3/8"	F NPTF	ANSI B1.20.3	NPTF 1/2" FEMALE	FFH06 12NPT M	71.8	2.83	33	1.3	19.7	0.78	30	1.18	
10	3/8"	F NPTF	ANSI B1.20.3	NPTF 3/8" FEMALE	FFH06 38NPT M	68.3	2.69	33	1.3	19.7	0.78	30	1.18	
10	3/8"	F BSPP	ISO 1179-1	BSPP 3/8" FEMALE	FFH06 38GAS M	68.3	2.69	33	1.3	19.7	0.78	30	1.18	
10	3/8"	F BSPP	ISO 1179-1	BSPP 1/2" FEMALE	FFH06 12GAS M	73.3	2.89	33	1.3	19.7	0.78	30	1.18	

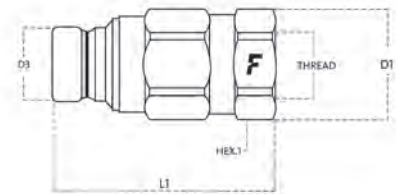

FFH

Size		Thread details			MALE									
mm	inch	Thread Type	Standard	Thread	Part Number	L (L1 + Thread)		D1		D3		HEX1		
						mm	inch	mm	inch	mm	inch	mm	inch	
12.5	1/2"	F NPTF	ANSI B1.20.3	NPTF 1/2" FEMALE	FFH08 12NPT MT	77	3.03	37	1.46	24.5	0.96	34	1.34	
12.5	1/2"	F JPT	UNI EN 10226-2	RC 1/2 FEMALE (JPT)	FFH08 12JPT M	77	3.03	37	1.46	24.5	0.96	34	1.34	
12.5	1/2"	07/ METRIC	ISO 8434-1-L	M22x1.5 MALE BULKHEAD SHORT 15L	FFH08-7/2215 M	91.5	3.6	37	1.46	24.5	0.96	34	1.34	
12.5	1/2"	61/ SAE	ISO 8434-2	9/16"-18 UN 90° MALE	FFH08-61/38S M	89	3.5	38	1.5	24.5	0.96	34	1.34	
12.5	1/2"	61/ SAE	ISO 8434-2	1-1/16"-12 UN 90° MALE	FFH08-61/34S M	89	3.5	38	1.5	24.5	0.96	34	1.34	
12.5	1/2"	05/ METRIC	ISO 8434-1-L	M18x1.5 MALE BULKHEAD 12L	FFH08-5/1815 M	99.5	3.92	37	1.46	24.5	0.96	34	1.34	
12.5	1/2"	02/ METRIC	ISO 8434-1-L	M22x1.5 MALE 15L	FFH08-2/2215 M	75.5	2.97	37	1.46	24.5	0.96	34	1.34	
12.5	1/2"	02/ METRIC	ISO 8434-1-L	M18x1.5 MALE 12L	FFH08-2/1815 M	74.5	2.93	37	1.46	24.5	0.96	34	1.34	
12.5	1/2"	14/ SAE	ISO 8434-2	7/8"-14 UNF MALE BULKHEAD JIC	FFH08-14/58S M	103.6	4.08	37	1.46	24.5	0.96	34	1.34	
12.5	1/2"	14/ SAE	ISO 8434-2	1-1/16"-12 UN MALE BULKHEAD JIC	FFH08-14/34S M	108.4	4.27	37	1.46	24.5	0.96	34	1.34	
12.5	1/2"	13/ SAE	ISO 8434-2	7/8"-14 UNF MALE JIC	FFH08-13/58S M	82.8	3.26	37	1.46	24.5	0.96	34	1.34	
12.5	1/2"	12/ SAE	ISO 8434-3	1"-14 UNS MALE BULKHEAD ORFS	FFH08-12/58S M	104	4.09	37	1.46	24.5	0.96	34	1.34	
12.5	1/2"	12/ SAE	ISO 8434-3	1-3/16"-12 UN MALE BULKHEAD ORFS	FFH08-12/34S M	105.5	4.15	37	1.46	24.5	0.96	34	1.34	
12.5	1/2"	12/ SAE	ISO 8434-3	13/16"-16 UN MALE BULKHEAD ORFS	FFH08-12/12S M	100	3.94	37	1.46	24.5	0.96	34	1.34	
12.5	1/2"	01/ METRIC	ISO 6149-2	M22x1.5 MALE	FFH08-1/2215 M	78.5	3.09	37	1.46	24.5	0.96	34	1.34	
12.5	1/2"	01/ SAE	ISO 11926-3	3/4"-16 UNF MALE	FFH08-1/12S M	74.6	2.94	37	1.46	24.5	0.96	34	1.34	
12.5	1/2"	01/ BSPP	ISO 1179-3	1/2" BSPP MALE	FFH08-1/12G M	78	3.07	37	1.46	24.5	0.96	34	1.34	
12.5	1/2"	0/ SAE	ISO 11926-1	7/8"-14 UNF FEMALE ORB	FFH08 58SAE M	76	2.99	37	1.46	24.5	0.96	34	1.34	
12.5	1/2"	F NPTF	ANSI B1.20.3	NPTF 3/4" FEMALE	FFH08 34NPT M	77	3.03	37	1.46	24.5	0.96	34	1.34	
12.5	1/2"	0/ SAE	ISO 11926-1	3/4"-16 UNF FEMALE ORB	FFH08 12SAE M	75	2.95	37	1.46	24.5	0.96	34	1.34	
12.5	1/2"	F BSPP	ISO 1179-1	BSPP 1/2" FEMALE	FFH08 12GAS MV	75	2.95	37	1.46	24.5	0.96	34	1.34	
12.5	1/2"	0/ SAE	ISO 11926-1	1-1/16"-12 UN FEMALE ORB	FFH08 34SAE M	81	3.19	37	1.46	24.5	0.96	34	1.34	
12.5	1/2"	F NPTF	ANSI B1.20.3	NPTF 1/2" FEMALE	FFH08 12NPT M	77	3.03	37	1.46	24.5	0.96	34	1.34	
12.5	1/2"	F BSPP	ISO 1179-1	BSPP 3/4" FEMALE	FFH08 34GAS M	78	3.07	37	1.46	24.5	0.96	34	1.34	
12.5	1/2"	F BSPP	ISO 1179-1	BSPP 1/2" FEMALE	FFH08 12GAS M	75	2.95	37	1.46	24.5	0.96	34	1.34	
16	5/8"	06/ METRIC	ISO 8434-1-S	M24x1.5 MALE BULKHEAD 16S	FFH10-6/2415 M	115.7	4.56	45	1.77	27	1.06	41	1.61	
16	5/8"	05/ METRIC	ISO 8434-1-L	M26x1.5 MALE BULKHEAD 18L	FFH10-5/2615 M	115.7	4.56	45	1.77	27	1.06	41	1.61	
16	5/8"	03/ METRIC	ISO 8434-1-S	M24x1.5 MALE 16S	FFH10-3/2415 M	89.7	3.53	45	1.77	27	1.06	41	1.61	
16	5/8"	02/ METRIC	ISO 8434-1-L	M26x1.5 MALE 18L	FFH10-2/2615 M	87.7	3.45	45	1.77	27	1.06	41	1.61	
16	5/8"	01/ SAE	ISO 11926-3	7/8"-14 UNF MALE	FFH10-1/58S M	88.4	3.48	45	1.77	27	1.06	41	1.61	
16	5/8"	01/ SAE	ISO 11926-3	1-1/16"-12 UN MALE	FFH10-1/34S M	90.8	3.57	45	1.77	27	1.06	41	1.61	
16	5/8"	F BSPP	ISO 1179-1	BSPP 5/8" FEMALE	FFH10 58GAS M	91.1	3.59	45	1.77	27	1.06	41	1.61	
16	5/8"	0/ SAE	ISO 11926-1	1-1/16"-12 UN FEMALE ORB	FFH10 34SAE M	94.1	3.7	45	1.77	27	1.06	41	1.61	
16	5/8"	F NPTF	ANSI B1.20.3	NPTF 3/4" FEMALE	FFH10 34NPT M	91.1	3.59	45	1.77	27	1.06	41	1.61	
16	5/8"	F BSPP	ISO 1179-1	BSPP 3/4" FEMALE	FFH10 34GAS M	91.1	3.59	45	1.77	27	1.06	41	1.61	
20	3/4"	F JPT	UNI EN 10226-2	RC 3/4 FEMALE (JPT)	FFH12 34JPT M	101.5	4	46	1.81	29.95	1.18	42	1.65	
20	3/4"	06/ METRIC	ISO 8434-1-S	M30x2 MALE BULKHEAD 20S	FFH12-6/3020 M	129.9	5.11	46	1.81	29.95	1.18	42	1.65	
20	3/4"	14/ SAE	ISO 8434-2	1-1/16"-12 UN MALE BULKHEAD JIC	FFH12-14/34S M	130.3	5.13	46	1.81	29.95	1.18	42	1.65	
20	3/4"	13/ SAE	ISO 8434-2	1-1/16"-12 UN MALE JIC	FFH12-13/34S M	107.8	4.24	46	1.81	29.95	1.18	42	1.65	
20	3/4"	12/ SAE	ISO 8434-3	1-3/16"-12 UN MALE BULKHEAD ORFS	FFH12-12/34S M	127.4	5.02	46	1.81	29.95	1.18	42	1.65	
20	3/4"	01/ SAE	ISO 11926-3	1-1/16"-12 UN MALE	FFH12-1/34S M	101	3.98	46	1.81	29.95	1.18	42	1.65	
20	3/4"	0/ SAE	ISO 11926-1	1-1/16"-12 UN FEMALE ORB	FFH12 34SAE M	101.6	4	46	1.81	29.95	1.18	42	1.65	
20	3/4"	F NPTF	ANSI B1.20.3	NPTF 3/4" FEMALE	FFH12 34NPT M	101.6	4	46	1.81	29.95	1.18	42	1.65	
20	3/4"	0/ SAE	ISO 11926-1	1-5/16"-12 UN FEMALE ORB	FFH12 1SAE M	101.6	4	46	1.81	29.95	1.18	42	1.65	
20	3/4"	F NPTF	ANSI B1.20.3	NPTF 1" FEMALE	FFH12 1NPT M	101.5	4	46	1.81	29.95	1.18	42	1.65	

FFH

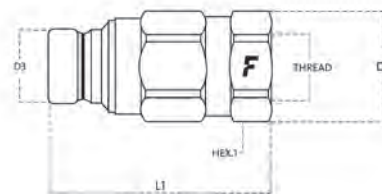

Size		Thread details			MALE								
mm	inch	Thread Type	Standard	Thread	Part Number	L (L1 + Thread)		D1		D3		HEX1	
						mm	inch	mm	inch	mm	inch	mm	inch
20	3/4"	F BSPP	ISO 1179-1	BSPP 1" FEMALE	FFH12 1GAS M	101.6	4	46	1.81	29.95	1.18	42	1.65
20	3/4"	F BSPP	ISO 1179-1	BSPP 3/4" FEMALE	FFH12 34GAS M	101.6	4	46	1.81	29.95	1.18	42	1.65
25	1"	06/ METRIC	ISO 8434-1-5	M36x2 MALE BULKHEAD 25S	FFH16-6/3620 M	140	5.51	59	2.32	36	1.42	55	2.17
25	1"	0/ SAE	ISO 11926-1	1-5/16"-12 UN FEMALE ORB	FFH16 1SAE M	106.5	4.19	59	2.32	36	1.42	55	2.17
25	1"	F NPTF	ANSI B1.20.3	NPTF 1" FEMALE	FFH16 1NPT M	107.5	4.23	59	2.32	36	1.42	55	2.17
25	1"	F NPTF	ANSI B1.20.3	NPTF 1-1/4" FEMALE	FFH16 114NPT M	106.5	4.19	59	2.32	36	1.42	55	2.17
25	1"	F BSPP	ISO 1179-1	BSPP 1-1/4" FEMALE	FFH16 114GAS M	109	4.29	59	2.32	36	1.42	55	2.17
25	1"	F BSPP	ISO 1179-1	BSPP 1-1/2" FEMALE	FFH16 112GAS M	110	4.33	59	2.32	36	1.42	55	2.17
25	1"	F BSPP	ISO 1179-1	BSPP 1" FEMALE	FFH16 1GAS M	106.5	4.19	59	2.32	36	1.42	55	2.17
31.5	1-1/4"	F BSPP	ISO 1179-1	BSPP 1-1/4" FEMALE	FFH20 114GAS M	109	4.29	59	2.32	44	1.73	55	2.17

Part number ending in V have seals in FKM and consequently a Working Temperature of -20°C + 200 °C.

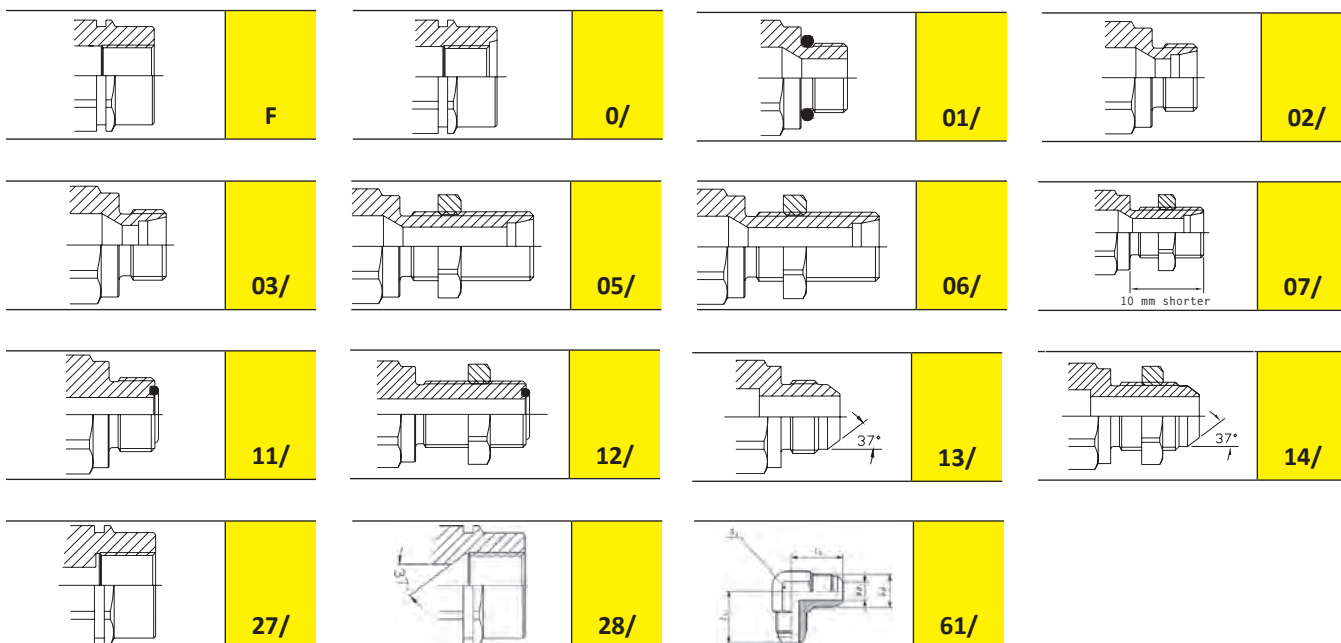

Flat Face

FFH Accessories and Spares

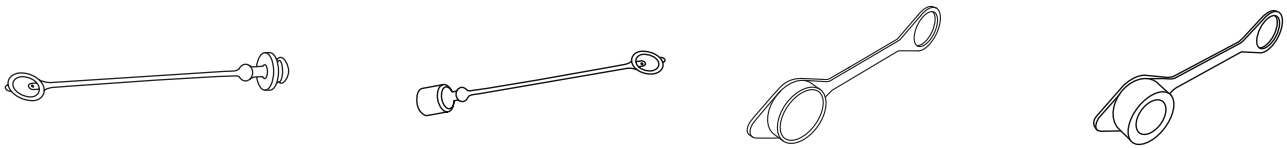

PVC dust protections

page 243

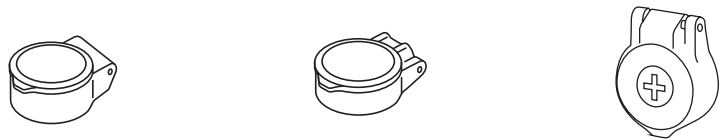

Acetal Resin dust protections

page 250

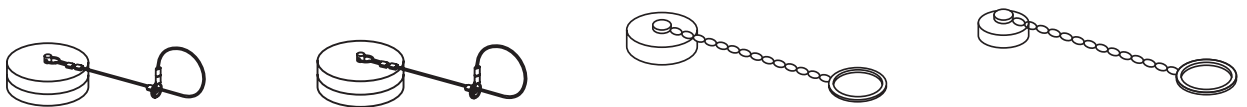

Aluminium dust protections

page 252



Seals Kits

page 262



FSH

Flat face female couplings, ISO 16028 interchange, 35 MPa series, sectors latching.

Flat face female couplings with real maximum working pressure of 35 MPa and Zinc-Nickel plating. The sector latching system enables to effectively tackle the Brinelling effect, provoked by high frequency impulse pressures. ISO 16028 interchange.



Applications



Pressure Drop

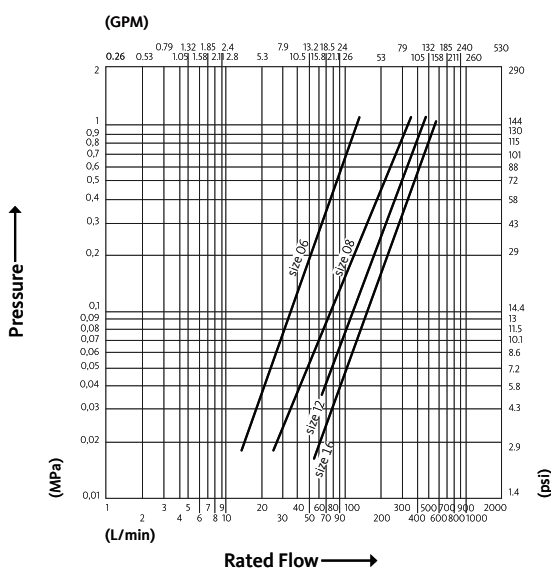

Test performed according to ISO 18869

Technical Specifications

dash	Size mm	inch	Working Pressure (MPa)	Flow Rate (l/min)	Spillage (ml)	Force to Connect (N)	Burst pressure (MPa)		
							Male	Female	Male + Female
06	10	3/8"	35	50	0.008	150	140	140	170
08	12.5	1/2"	35	110	0.01	210	140	140	170
12	20	3/4"	35	160	0.02	215	140	140	140
16	25	1"	35	230	0.03	280	140	140	170

Material	Steel
Seals	NBR; PUR
Working temperatures	- 25 °C to + 100 °C
Surface treatment	MATE 1000 (ZnNi)
Series Interchange	ISO 16028

Valve Type	Flat
Connection	Push to Connect
Disconnection	Sleeve Retraction
Connection Under Pressure	Not Allowed



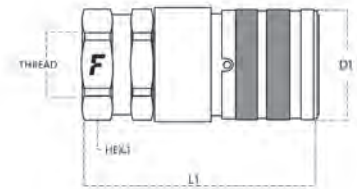

FSH

Size		Thread details			FEMALE						
mm	inch	Thread Type	Standard	Thread	Part Number	L (L1 + Thread)		D1		HEX1	
						mm	inch	mm	inch	mm	inch
10	3/8"	F BSPP	ISO 1179-1	BSPP 3/8" FEMALE	FSH06 38GAS F	75	2.95	30	1.18	27	1.06
10	3/8"	O2/ METRIC	ISO 8434-1-L	M18x1.5 MALE 12L	FSH06-2/1815 F	81	3.19	30	1.18	27	1.06
12.5	1/2"	F BSPP	ISO 1179-1	BSPP 1/2" FEMALE	FSH08 12GAS F	81.3	3.2	38	1.5	34	1.34
12.5	1/2"	O/ SAE	ISO 11926-1	1-1/16"-12 UN FEMALE ORB	FSH08 34SAE F	86.8	3.42	38	1.5	34	1.34
20	3/4"	F BSPP	ISO 1179-1	BSPP 3/4" FEMALE	FSH12 34GAS F	100	3.94	48	1.89	42	1.65
20	3/4"	O/ SAE	ISO 11926-1	1 - 1/16" - 12 UN FEMALE ORB	FSH12 34SAE F	104	4.09	48	1.89	42	1.65
25	1"	F BSPP	ISO 1179-1	BSPP 1" FEMALE	FSH16 1GAS F	100.5	3.96	55	2.17	50	1.97
25	1"	O/ SAE	ISO 11926-1	1-5/16"-12 UN FEMALE ORB	FSH16 1SAE F	100.5	3.96	55	2.17	50	1.97

FSH Accessories and Spares

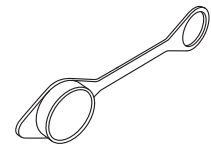

PVC dust protections

page 243



Acetal Resin dust protections

page 250



Aluminium dust protections

page 252

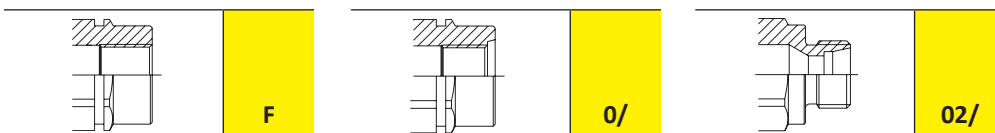

3FFH



Flat face couplings, ISO 16028, connection under pressure.

Flat face couplings, connectable under residual pressure. Real 35 MPa max working pressure. ISO 16028 interchange. Zinc-Nickel plating. It is possible to couple either a 3FFH female half under pressure with a FFH male half, or a 3FFH male half under pressure with a FFH female half.



Applications



Pressure Drop

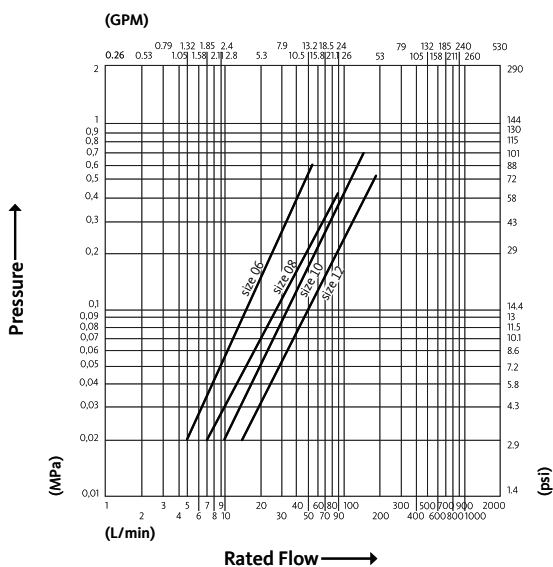

Test performed according to ISO 18869

Technical Specifications

dash	Size mm	inch	Working Pressure (MPa)	Flow Rate (l/min)	Spillage (ml)	Force to Connect (N)	Burst pressure (MPa)		
							Male	Female	Male + Female
06	10	3/8"	35	35	0.008	190	140	140	140
08	12.5	1/2"	35	65	0.01	200	140	140	140
10	16	5/8"	35	97	0.02	210	140	140	140
12	20	3/4"	35	115	0.02	220	140	140	140

Material	Steel
Seals	NBR; PUR
Working temperatures	- 25 °C to + 100 °C
Surface treatment	MATE 1000 (ZnNi)
Series Interchange	ISO 16028

Valve Type	Flat
Connection	Push to Connect
Disconnection	Sleeve Retraction
Connection Under Pressure	Allowed



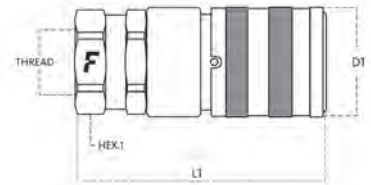

3FFH

Size		Thread details			FEMALE						
mm	inch	Thread Type	Standard	Thread	Part Number	L (L1 + Thread)		D1		HEX1	
						mm	inch	mm	inch	mm	inch
10	3/8"	F BSPP	ISO 1179-1	BSPP 3/8" FEMALE	3FFH06 38GAS F	75	2.95	30	1.18	27	1.06
10	3/8"	O2/ METRIC	ISO 8434-1-L	M22x1.5 MALE 15L	3FFH06-2/2215F	81.9	3.22	30	1.18	27	1.06
12.5	1/2"	F BSPP	ISO 1179-1	BSPP 1/2" FEMALE	3FFH08 12GAS F	81.3	3.2	38	1.5	34	1.34
12.5	1/2"	F NPTF	ANSI B1.20.3	NPTF 1/2" FEMALE	3FFH08 12NPT F	81.3	3.2	38	1.5	34	1.34
12.5	1/2"	O/ SAE	ISO 11926-1	7/8"-14 UNF FEMALE ORB	3FFH08 58SAE F	81.3	3.2	38	1.5	34	1.34
12.5	1/2"	O/ SAE	ISO 11926-1	1-1/16"-12 UN FEMALE ORB	3FFH08 34SAE FA	86.8	3.42	38	1.5	34	1.34
12.5	1/2"	61/ SAE	ISO 8434-2	9/16"-18 UN 90° MALE	3FFH08-61/38SFS	100.8	3.97	38	1.5	34	1.34
12.5	1/2"	61/ SAE	ISO 8434-2	1-1/16"-12 UN 90° MALE	3FFH08-61/34SFS	100.8	3.97	38	1.5	34	1.34
20	3/4"	F BSPP	ISO 1179-1	BSPP 3/4" FEMALE	3FFH12 34GAS F	100	3.94	48	1.89	42	1.65

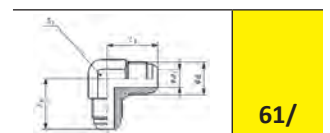
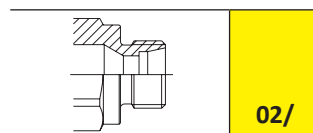
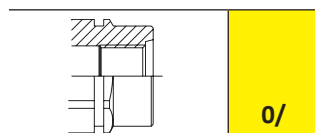
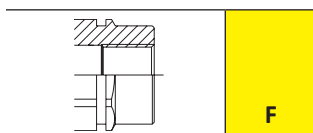

3FFH

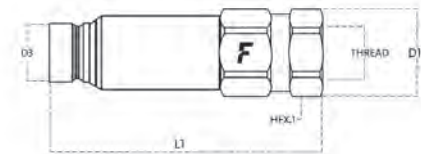

Size		Thread details			MALE									
mm	inch	Thread Type	Standard	Thread	Part Number	L (L1 + Thread)		D1		D3		HEX1		
						mm	inch	mm	inch	mm	inch	mm	inch	
10	3/8"	F NPTF	ANSI B1.20.3	NPTF 3/8" FEMALE	3FFH06 38NPT M	96.8	3.81	33	1.3	19.7	0.78	30	1.18	
10	3/8"	F BSPP	ISO 1179-1	BSPP 3/8" FEMALE	3FFH06 38GAS M	96.8	3.81	30	1.18	19.7	0.78	30	1.18	
10	3/8"	O/ SAE	ISO 11926-1	3/4"-16 UNF FEMALE ORB	3FFH06 12SAE M	100.3	3.95	33	1.3	19.7	0.78	30	1.18	
10	3/8"	F BSPP	ISO 1179-1	BSPP 1/2" FEMALE	3FFH06 12GAS M	101.8	4.01	33	1.3	19.7	0.78	30	1.18	
12.5	1/2"	14/ SAE	ISO 8434-2	7/8"-14 UNF MALE BULKHEAD JIC	3FFH08-14/58S M	144.3	5.68	37	1.46	24.5	0.96	34	1.34	
12.5	1/2"	14/ SAE	ISO 8434-2	1-1/16"-12 UN MALE BULKHEAD JIC	3FFH08-14/34SMB	149.1	5.87	37	1.46	24.5	0.96	34	1.34	
12.5	1/2"	14/ SAE	ISO 8434-2	1-1/16"-12 UN MALE BULKHEAD JIC	3FFH08-14/34S M	149.1	5.87	37	1.46	24.5	0.96	34	1.34	
12.5	1/2"	14/ SAE	ISO 8434-2	3/4"-16 UN MALE BULKHEAD JIC	3FFH08-14/12S M	140.8	5.54	37	1.46	24.5	0.96	34	1.34	
12.5	1/2"	12/ SAE	ISO 8434-3	1"-14 UNS MALE BULKHEAD ORFS	3FFH08-12/58S M	144.7	5.7	37	1.46	24.5	0.96	34	1.34	
12.5	1/2"	12/ SAE	ISO 8434-3	1-3/16"-12 UN MALE BULKHEAD ORFS	3FFH08-12/34S M	146.2	5.76	37	1.46	24.5	0.96	34	1.34	
12.5	1/2"	O/ SAE	ISO 11926-1	7/8"-14 UNF FEMALE ORB	3FFH08 58SAE M	116.7	4.59	37	1.46	24.5	0.96	34	1.34	
12.5	1/2"	O/ SAE	ISO 11926-1	1-1/16"-12 UN FEMALE ORB	3FFH08 34SAE M	121.7	4.79	37	1.46	24.5	0.96	34	1.34	
12.5	1/2"	F BSPP	ISO 1179-1	BSPP 3/4" FEMALE	3FFH08 34GAS M	118.7	4.67	37	1.46	24.5	0.96	34	1.34	
12.5	1/2"	O/ SAE	ISO 11926-1	3/4"-16 UNF FEMALE ORB	3FFH08 12SAE M	115.7	4.56	37	1.46	24.5	0.96	34	1.34	
12.5	1/2"	F NPTF	ANSI B1.20.3	NPTF 1/2" FEMALE	3FFH08 12NPT M	117.7	4.63	37	1.46	24.5	0.96	34	1.34	
12.5	1/2"	F BSPP	ISO 1179-1	BSPP 1/2" FEMALE	3FFH08 12GAS M	115.7	4.56	37	1.46	24.5	0.96	34	1.34	
16	5/8"	O/ SAE	ISO 11926-1	1-1/16"-12 UN FEMALE ORB	3FFH10 34SAE M	126.8	4.99	45	1.77	27	1.06	41	1.61	
16	5/8"	F NPTF	ANSI B1.20.3	NPTF 3/4" FEMALE	3FFH10 34NPT M	123.8	4.87	45	1.77	27	1.06	41	1.61	
20	3/4"	O1/ SAE	ISO 11926-3	1-1/16"-12 UN MALE	3FFH12-1/34S M	128	5.04	46	1.81	29.95	1.18	42	1.65	
20	3/4"	O/ SAE	ISO 11926-1	1-1/16"-12 UN FEMALE ORB	3FFH12 34SAE M	128.4	5.06	46	1.81	29.95	1.18	42	1.65	
20	3/4"	F BSPP	ISO 1179-1	BSPP 3/4" FEMALE	3FFH12 34GAS M	128.4	5.06	46	1.81	29.95	1.18	42	1.65	
20	3/4"	F BSPP	ISO 1179-1	BSPP 1" FEMALE	3FFH12 1GAS M	128.4	5.06	46	1.81	29.95	1.18	42	1.65	

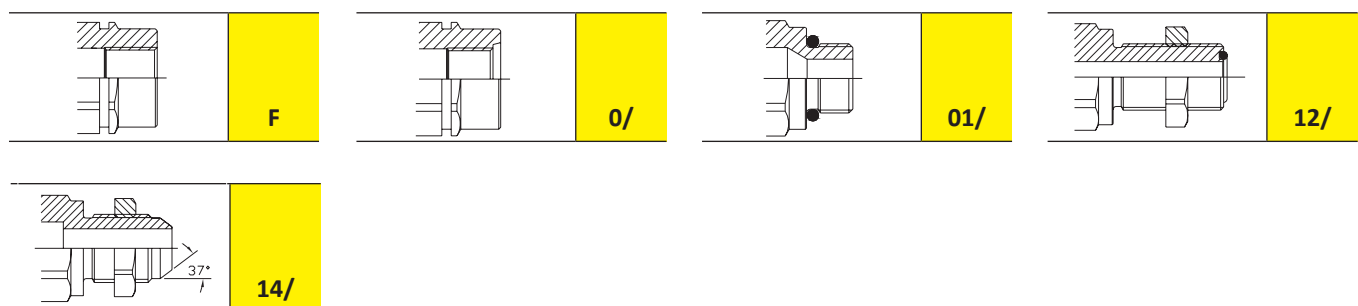

3FFH Accessories and Spares

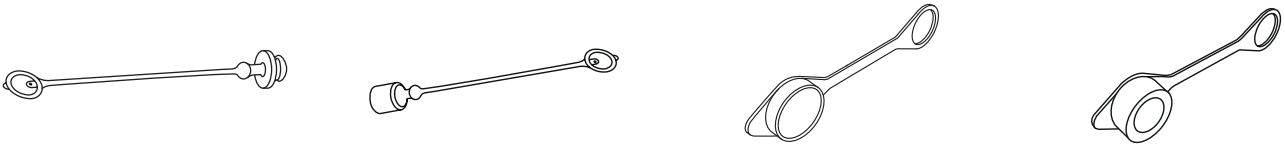

PVC dust protections

page 243

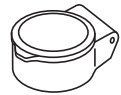

Acetal Resin dust protections

page 250



Aluminium dust protections

page 252



2FSI - FFI

Sectors latching couplings. Size 1-1/2", 2", 3".

Flat face couplings equipped with sector latching system. High resistance to the Brinelling effect, provoked by high frequency impulse pressures. Available on 1", 1-1/2", 2" and 3" sizes. MARKET interchange.



Applications



Pressure Drop

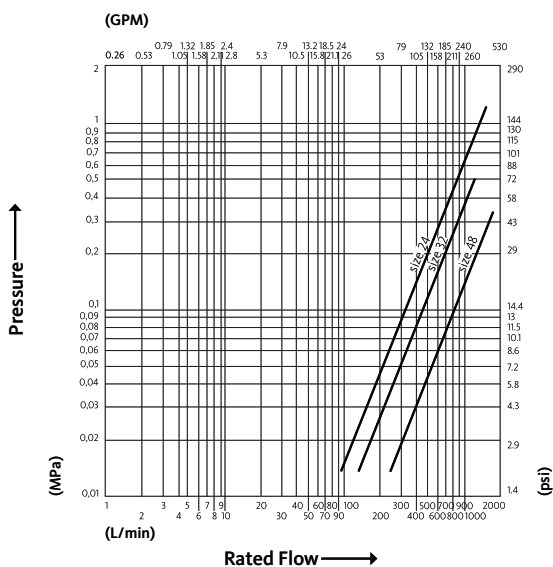

Technical Specifications

dash	Size		Working Pressure (MPa)	Flow Rate (l/min)	Spillage (ml)	Force to Connect (N)	Burst pressure (MPa)		
	mm	inch					Male	Female	Male + Female
24	37.5	1-1/2"	25	500	0.05	345	120	100	125
32	50	2"	25	1000	0.1	430	80	50	100
48	75	3"	12	1150	0.1	520	80	50	80

Material	Steel
Seals	NBR; PUR
Working temperatures	- 25 °C to + 100 °C
Surface treatment	MATE 500 (CrIII)
Series Interchange	MARKET

Valve Type	Flat
Connection	Push to Connect
Disconnection	Sleeve Retraction
Connection Under Pressure	Not Allowed



2FSI - FFI

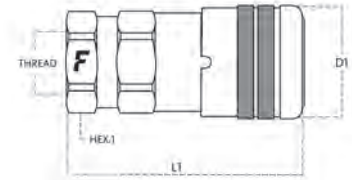

Size		Thread details			FEMALE							
mm	inch	Thread Type	Standard	Thread	Part Number	L (L1 + Thread)		D1		HEX1		
						mm	inch	mm	inch	mm	inch	
37.5	1-1/2"	F BSPP	ISO 1179-1	BSPP 1-1/2" FEMALE	2FSI112 GAS F	133.4	5.25	80	3.15	70	2.76	
37.5	1-1/2"	F NPTF	ANSI B1.20.3	NPTF 1-1/2" FEMALE	2FSI112 NPT F	133.4	5.25	80	3.15	70	2.76	
50	2"	F BSPP	ISO 1179-1	BSPP 2" FEMALE	2FSI 2 GAS F	158.1	6.22	100	3.94	80	3.15	
75	3"	F BSPP	ISO 1179-1	BSPP 3" FEMALE	2FSI 3 GAS F	211.5	8.33	159	6.26	115	4.53	

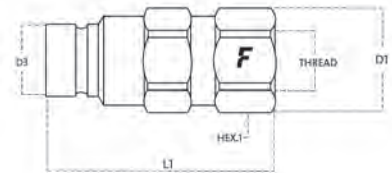

Size		Thread details			MALE									
mm	inch	Thread Type	Standard	Thread	Part Number	L (L1 + Thread)		D1		D3		HEX1		
						mm	inch	mm	inch	mm	inch	mm	inch	
37.5	1-1/2"	F NPTF	ANSI B1.20.3	NPTF 1-1/2" FEMALE	FFI112 NPT M	104.2	4.1	70	2.76	57	2.24	65	2.56	
37.5	1-1/2"	F BSPP	ISO 1179-1	BSPP 1-1/2" FEMALE	FFI112 GAS M	104.2	4.1	70	2.76	57	2.24	65	2.56	
50	2"	F BSPP	ISO 1179-1	BSPP 2" FEMALE	FFI 2 GAS M	142	5.59	90	3.54	73	2.87	80	3.15	
75	3"	F BSPP	ISO 1179-1	BSPP 3" FEMALE	FFI 3 GAS M	182.3	7.18	159	6.26	125	4.92	115	4.53	

2FSI - FFI Accessories and Spares



Aluminium dust protections

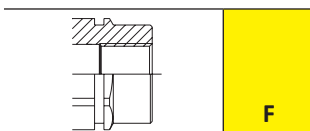



2FFI brass

Flat face couplings, ISO 16028, brass.

Flat face couplings, with brass components and seals in Viton. Suitable for industrial applications. ISO 16028 interchange.



Applications



Pressure Drop

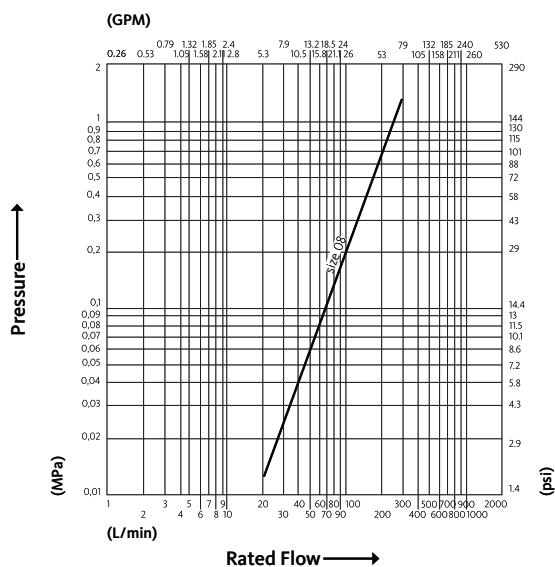

Test performed according to ISO 18869

Technical Specifications

dash	Size mm	inch	Working Pressure (MPa)	Flow Rate (l/min)	Spillage (ml)	Force to Connect (N)	Burst pressure (MPa)		
							Male	Female	Male + Female
08	12.5	1/2"	12	100	0.01	220	50	50	50

Material	Brass
Seals	VITON
Working temperatures	- 20 °C to + 200 °C
Surface treatment	
Series Interchange	ISO 16028

Valve Type	Flat
Connection	Push to Connect
Disconnection	Sleeve Retraction
Connection Under Pressure	Not Allowed



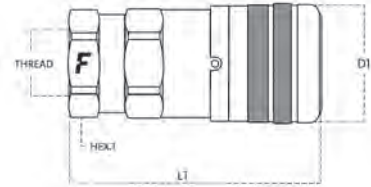

2FFI brass

Size		Thread details			FEMALE							
mm	inch	Thread Type	Standard	Thread	Part Number	L (L1 + Thread)		D1		HEX1		
						mm	inch	mm	inch	mm	inch	
12.5	1/2"	F NPTF	ANSI B1.20.3	NPTF 3/4" FEMALE	2FFI12-34NPTF5V	86.4	3.4	38	1.5	34	1.34	

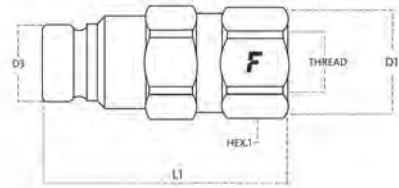

Size		Thread details			MALE								
mm	inch	Thread Type	Standard	Thread	Part Number	L (L1 + Thread)		D1		D3		HEX1	
						mm	inch	mm	inch	mm	inch	mm	inch
12.5	1/2"	F NPTF	ANSI B1.20.3	NPTF 3/4" FEMALE	FFI12-34NPTM5V	81.5	3.21	38	1.5	24.5	0.96	34	1.34

2FFI brass Accessories and Spares

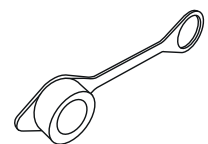
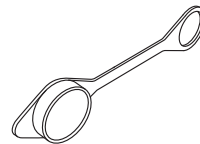

PVC dust protections

page 243



Aluminium dust protections

page 252

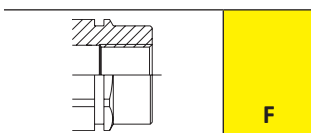



2FFI stainless steel

Flat face couplings, ISO 16028, stainless steel.

Flat face couplings, with stainless steel (AISI 316) components and seals in Viton. High resistance to corrosion. ISO 16028 interchangeable.



Applications



Pressure Drop

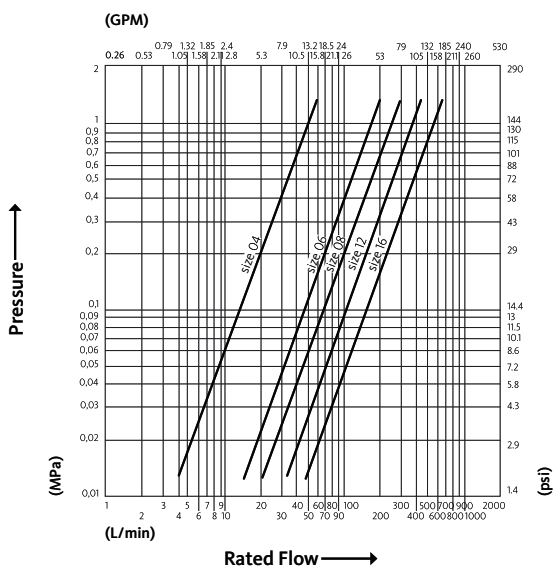

Test performed according to ISO 18869

Technical Specifications

dash	Size		Working Pressure (MPa)	Flow Rate (l/min)	Spillage (ml)	Force to Connect (N)	Burst pressure (MPa)		
	mm	inch					Male	Female	Male + Female
04	6.3	1/4"	25	20	0.006	95	100	100	100
06	10	3/8"	25	45	0.008	115	100	100	100
08	12.5	1/2"	25	100	0.01	220	100	100	100
12	20	3/4"	25	160	0.02	215	100	100	100
16	25	1"	25	210	0.03	280	100	100	100

Material	Stainless Steel
Seals	VITON
Working temperatures	- 20 °C to + 200 °C
Surface treatment	
Series Interchange	ISO 16028

Valve Type	Flat
Connection	Push to Connect
Disconnection	Sleeve Retraction
Connection Under Pressure	Not Allowed



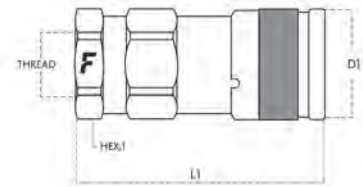

2FFI stainless steel

Size		Thread details			FEMALE							
mm	inch	Thread Type	Standard	Thread	Part Number	L (L1 + Thread)		D1		HEX1		
						mm	inch	mm	inch	mm	inch	
6.3	1/4"	F NPTF	ANSI B1.20.3	NPTF 1/4" FEMALE	2FFI14 NPT F 2	58.6	2.31	27	1.06	24	0.94	
6.3	1/4"	F BSPP	ISO 1179-1	BSPP 1/4" FEMALE	2FFI14 GAS F2V	58.6	2.31	27	1.06	24	0.94	
10	3/8"	F BSPP	ISO 1179-1	BSPP 1/2" FEMALE	2FFN38-12GASF2V	74.9	2.95	30	1.18	27	1.06	
10	3/8"	F BSPP	ISO 1179-1	BSPP 3/8" FEMALE	2FFN38 GAS F 2V	73.2	2.88	30	1.18	27	1.06	
10	3/8"	O3/ METRIC	ISO 8434-1-S	M18x1.5 MALE 10S	2FFN38-3/18 F2V	73.8	2.91	30	1.18	27	1.06	
12.5	1/2"	F BSPP	ISO 1179-1	BSPP 1/2" FEMALE	2FFI12 GAS F 2V	81.9	3.22	38	1.5	32	1.26	
20	3/4"	F NPTF	ANSI B1.20.3	NPTF 3/4" FEMALE	2FFI34 NPT F 2V	100.3	3.95	48	1.89	42	1.65	
20	3/4"	F BSPP	ISO 1179-1	BSPP 3/4" FEMALE	2FFI34 GAS F 2V	100.3	3.95	48	1.89	41	1.61	
25	1"	F BSPP	ISO 1179-1	BSPP 1" FEMALE	2FFI 1 GAS F 2V	101	3.98	55	2.17	50	1.97	

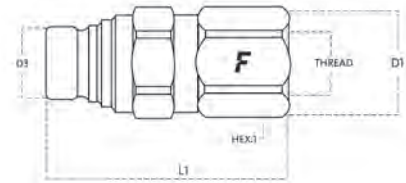

Size		Thread details			MALE								
mm	inch	Thread Type	Standard	Thread	Part Number	L (L1 + Thread)		D1		D3		HEX1	
						mm	inch	mm	inch	mm	inch	mm	inch
6.3	1/4"	F BSPP	ISO 1179-1	BSPP 1/4" FEMALE	FFI14 GAS M2V	62.8	2.47	26	1.02	16.1	0.63	24	0.94
10	3/8"	F BSPP	ISO 1179-1	BSPP 1/2" FEMALE	FFN38-12GAS M2V	71	2.8	30	1.18	19.7	0.78	27	1.06
10	3/8"	F BSPP	ISO 1179-1	BSPP 3/8" FEMALE	FFN38 GAS M 2V	67	2.64	30	1.18	19.7	0.78	30	1.18
10	3/8"	O3/ METRIC	ISO 8434-1-S	M18x1.5 MALE 10S	FFN38-3/18 M2V	68	2.68	30	1.18	19.7	0.78	27	1.06
12.5	1/2"	F BSPP	ISO 1179-1	BSPP 1/2" FEMALE	FFI12 GAS M 2V	83.6	3.29	35	1.38	24.5	0.96	32	1.26
20	3/4"	F NPTF	ANSI B1.20.3	NPTF 3/4" FEMALE	FFI34 NPT M 2V	99.4	3.91	46	1.81	29.9	1.18	42	1.65
20	3/4"	F BSPP	ISO 1179-1	BSPP 3/4" FEMALE	FFI34 GAS M 2V	99.4	3.91	46	1.81	29.9	1.18	42	1.65
25	1"	F BSPP	ISO 1179-1	BSPP 1" FEMALE	FFI 1 GAS M 2V	107.7	4.24	55	2.17	36	1.42	50	1.97



2FFI stainless steel Accessories and Spares

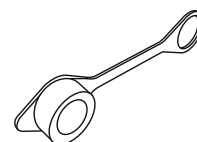
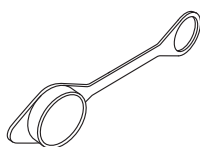

PVC dust protections

page 243



Aluminium dust protections

page 252

FFC



Flat face cartridge couplings, stainless steel.

Self-aligning flat face couplings for multiconnections. Misalignments up to ± 0.5 mm and $\pm 1^\circ$ (angular) are automatically compensated during the connection. Stainless steel components (AISI 316) with Viton seals. Faster proprietary profile. Cartridges without thread, to be installed into machined housing.



Applications



Pressure Drop

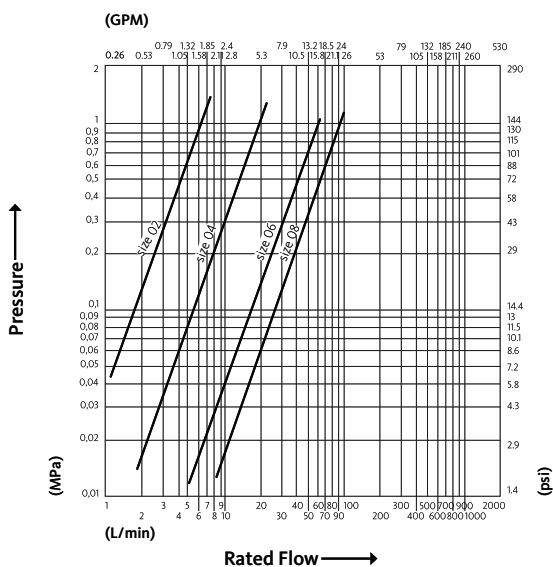

Test performed according to ISO 18869

Technical Specifications

dash	Size mm	inch	Working Pressure (MPa)	Flow Rate (l/min)	Spillage (ml)	Force to Connect (N)	Burst pressure (MPa)		
							Male	Female	Male + Female
02	3.2	1/8"	25	2.5	0.002	80	100	100	130
04	6.3	1/4"	32	8	0.002	80	150	90	130
06	10	3/8"	25	23	0.006	110	90	100	100
08	12.5	1/2"	45	35	0.006	185	140	80	180

Material	Stainless Steel
Seals	VITON
Working temperatures	- 20 °C to +200 °C
Surface treatment	
Series Interchange	MARKET

Valve Type	Flat
Connection	Special
Disconnection	Special
Connection Under Pressure	Not Allowed



FFC

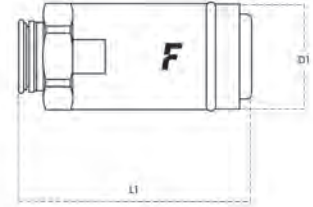

Size		Thread details			FEMALE						
mm	inch	Thread Type	Standard	Thread	Part Number	L (L1 + Thread)		D1		HEX1	
						mm	inch	mm	inch	mm	inch
6.3	1/4"				FFC14 F 2V	44.8	1.76	19	0.75		
10	3/8"				FFC38 F 2V	49.3	1.94	23.9	0.94		
12.5	1/2"				FFC12 F 2V	70.8	2.79	31.3	1.23		

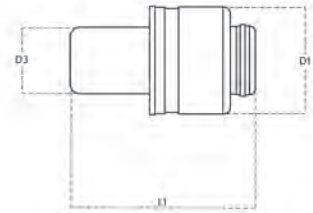

Size		Thread details			MALE								
mm	inch	Thread Type	Standard	Thread	Part Number	L (L1 + Thread)		D1		D3		HEX1	
						mm	inch	mm	inch	mm	inch	mm	inch
6.3	1/4"				FFC14 M 2V	36	1.42	19.6	0.77	12.1	0.48		
10	3/8"				FFC38 M 2V	40.5	1.59	24.5	0.96	16.1	0.63		
12.5	1/2"				FFC12 M 2V	56	2.2	32.5	1.28	19.7	0.78		

OGF

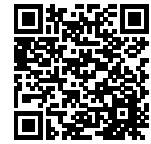

Flat face Push-to-Connect couplings. Equipped with locking ball to prevent accidental disconnection. Available in 5 different sizes

OGF couplings are designed for a wide range of applications. The flat face design guarantees zero spillage and prevents external contamination. Push-to-Connect technology to make connection maneuver easier. Equipped with locking ball to prevent accidental disconnection. Available in 5 different sizes. Interchangeable with Snap-tite 71 series. Thread: NPT (others options available upon request).



Applications



Pressure Drop

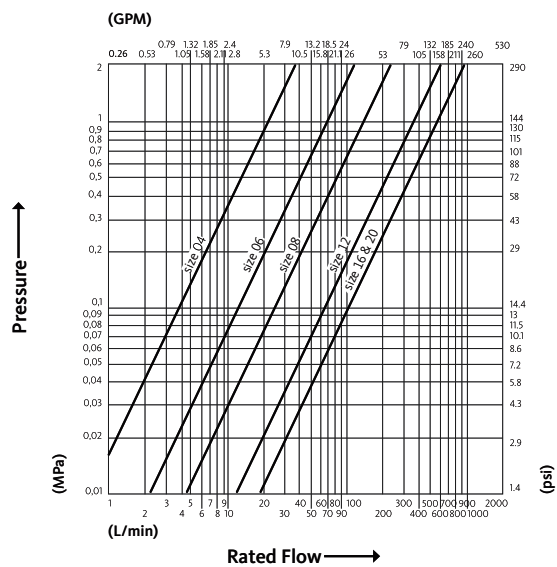

Test performed according to ISO 18869

Technical Specifications

dash	Size mm	inch	Working Pressure (MPa)	Flow Rate (l/min)	Spillage (ml)	Force to Connect (N)	Burst pressure (MPa)		
							Male	Female	Male + Female
06	10	3/8"	53	32	0.01	140	140	160	
08	12.5	1/2"	53	70	0.01	140	140	160	
12	20	3/4"	46	120	0.02	140	140	160	
16	25	1"	53	200	0.03	140	140	160	
20	31.5	1-1/4"	46	350	0.03	140	140	160	
24	37.5	1-1/2"	46	420	0.03	140	140	160	
32	50	2"	35	750	0.03	100	80	120	

Material	Steel
Seals	FKM & PUR
Working temperatures	- 20 °C to 100 °C
Surface treatment	MATE 1000 (ZnNi)
Series Interchange	FASTER

Valve Type	Flat
Connection	Screw to Connect
Disconnection	Unscrew to Disconnect
Connection Under Pressure	Allowed Male Half up to W.P.



OGF

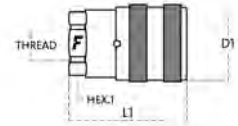

Size		Thread details			FEMALE							
mm	inch	Thread Type	Standard	Thread	Part Number	L (L1 + Thread)		D1		HEX1		
						mm	inch	mm	inch	mm	inch	
6.3	1/4"	F NPTF	ANSI B1.20.3	NPTF 1/4" FEMALE	OGF04 14NPT F	51.7	2.04	30	1.18	24	0.94	
10	3/8"	F NPTF	ANSI B1.20.3	NPTF 3/8" FEMALE	OGF06 38NPT F	61.7	2.43	40	1.58	30	1.18	
12.5	1/2"	F NPTF	ANSI B1.20.3	NPTF 1/2" FEMALE	OGF08 12NPT F	71	2.80	48	1.89	38	1.50	
20	3/4"	F NPTF	ANSI B1.20.3	NPTF 3/4" FEMALE	OGF12 34NPT F	79	3.11	58	2.28	46	1.81	
25	1"	F NPTF	ANSI B1.20.3	NPTF 1" FEMALE	OGF16 1NPT F	87.8	3.46	68	2.68	50	1.97	

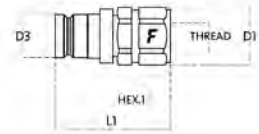

Size		Thread details			MALE									
mm	inch	Thread Type	Standard	Thread	Part Number	L (L1 + Thread)		D1		D3		HEX1		
						mm	inch	mm	inch	mm	inch	mm	inch	
6.3	1/4"	F NPTF	ANSI B1.20.3	NPTF 1/4" FEMALE	OGF04 14NPT M	2.13	54.0	0.95	24.0	0.71	18	0.87	22	
10	3/8"	F NPTF	ANSI B1.20.3	NPTF 3/8" FEMALE	OGF06 38NPT M	2.52	64.0	1.26	31.9	0.93	23.7	1.18	30	
12.5	1/2"	F NPTF	ANSI B1.20.3	NPTF 1/2" FEMALE	OGF08 12NPT M	2.91	74.0	1.54	39.0	1.18	30	1.42	36	
20	3/4"	F NPTF	ANSI B1.20.3	NPTF 3/4" FEMALE	OGF12 34NPT M	3.43	87.0	1.77	45.0	1.52	38.6	1.61	41	
25	1"	F NPTF	ANSI B1.20.3	NPTF 1" FEMALE	OGF16 1NPT M	3.60	91.5	2.17	55.0	1.77	44.95	1.97	50	

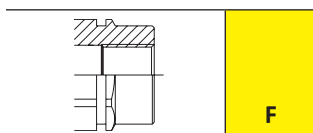

FHV



Screw to connect flat face coupling.

Screw-on flat face couplings, suitable to construction equipment and heavy duty applications. The Zinc-Nickel plating guarantees a remarkable resistance to corrosion. Connectable by hand up to 35 MPa residual pressure in the male half. No hose torsion during connection and disconnection thanks to the internal bearing system. Equipped with a safety sleeve to prevent accidental disconnections due to vibrations. Aluminum and pvc dust caps available. Faster proprietary profile. Part Number with ET have Extended Temperature range (from -30° to 120 °C) in connected configuration. Part Number with HD (Heavy Duty) are equipped with a double Bearing Ball system and greasing nipple.



Applications



Pressure Drop

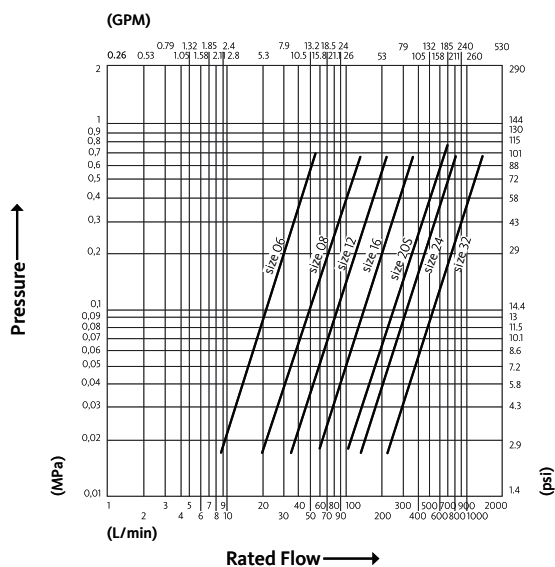

Test performed according to ISO 18869

Technical Specifications

dash	Size		Working Pressure (MPa)	Flow Rate (l/min)	Spillage (ml)	Force to Connect (N)	Burst pressure (MPa)		
	mm	inch					Male	Female	Male + Female
06	10	3/8"	53 MPa	32	0.01		140	140	160
08	12.5	1/2"	53 MPa	70	0.01		140	140	160
12	20	3/4"	46 MPa	120	0.02		140	140	160
16	25	1"	53 MPa	200	0.03		140	140	160
20	31.5	1-1/4"	46 MPa	350	0.03		140	140	160
24	37.5	1-1/2"	46 MPa	420	0.03		140	140	160
32	50	2"	35 MPa	750	0.03		100	80	120

Material	Steel
Seals	VITON; PUR
Working temperatures	- 20 °C to + 100 °C
Surface treatment	MATE 1000 (ZnNi)
Series Interchange	FASTER

Valve Type	Flat
Connection	Screw to Connect
Disconnection	Unscrew to Disconnect
Connection Under Pressure	Allowed Male Half up to W.P.



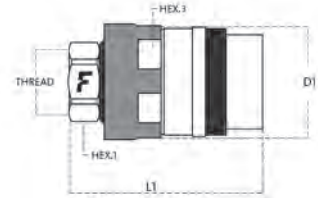

FHV

Size		Thread details			FEMALE									
mm	inch	Thread Type	Standard	Thread	Part Number	L (L1 + Thread)		D1		HEX1		HEX3		
						mm	inch	mm	inch	mm	inch	mm	inch	
10	3/8"	71/ BSPP	JIS B 2351-1	BSPP 3/8" FEMALE ORB	FHV06-71/38G F	102	4.02	48	1.89	45	1.77	34	1.34	
10	3/8"	F NPTF	ANSI B1.20.3	NPTF 3/8" FEMALE	FHV06 38NPT F	101.8	4.01	48	1.89	34	1.34	45	1.77	
10	3/8"	F BSPP	ISO 1179-1	BSPP 3/8" FEMALE	FHV06 38GAS F	101.8	4.01	48	1.89	34	1.34	45	1.77	
12.5	1/2"	71/ BSPP	JIS B 2351-1	BSPP 1/2 FEMALE ORB	FHV08-71/12G F	109.7	4.32	55	2.17	41	1.61	52	2.05	
12.5	1/2"	F BSPP	ISO 1179-1	BSPP 3/4" FEMALE	FHV08 34GAS F	109.7	4.32	55	2.17	41	1.61	52	2.05	
12.5	1/2"	F NPTF	ANSI B1.20.3	NPTF 1/2" FEMALE	FHV08 12NPT F	109.7	4.32	55	2.17	41	1.61	52	2.05	
12.5	1/2"	F BSPP	ISO 1179-1	BSPP 1/2" FEMALE	FHV08 12GAS F	109.7	4.32	55	2.17	41	1.61	52	2.05	
20	3/4"	0/ BSPP	BS 5380	BSPP 3/4 FEMALE ORB	FHV12-71/34G F	129.5	5.1	64	2.52	46	1.81	60	2.36	
20	3/4"	F NPTF	ANSI B1.20.3	NPTF 3/4" FEMALE	FHV12 34NPT F	129.5	5.1	64	2.52	46	1.81	60	2.36	
20	3/4"	F BSPP	ISO 1179-1	BSPP 3/4" FEMALE	FHV12 34GAS F	129.5	5.1	64	2.52	46	1.81	60	2.36	
20	3/4"	F BSPP	ISO 1179-1	BSPP 1" FEMALE	FHV12 1GAS F	129.5	5.1	64	2.52	46	1.81	60	2.36	
25	1"	F BSPP	ISO 1179-1	BSPP 1" FEMALE	FHV16 1GAS F HD1*	138	5.43	70	2.76	55	2.17	70	2.76	
25	1"	03/ METRIC	ISO 8434-1-5	M42x2 MALE 30S	FHV16-3/4220 F	158	6.22	74	2.91	55	2.17	70	2.76	
25	1"	76/ SAE	ISO 6162-2	SAE FLANGE HEAD 1-1/4	FHV16-76/20 F	198	7.8	74	2.91	55	2.17	70	2.76	
25	1"	76/ SAE	ISO 6162-2	SAE FLANGE HEAD 1	FHV16-76/16 F	191	7.52	74	2.91	55	2.17	70	2.76	
25	1"	0/ BSPP	BS 5380	BSPP 1 FEMALE ORB	FHV16-71/1G F	138	5.43	74	2.91	55	2.17	70	2.76	
25	1"	44/ METRIC	ISO 6162-1	METRIC FLANGE 1-1/4	FHV16-44A/20 F	158	6.22	94.6	3.72	55	2.17	70	2.76	
25	1"	44/ METRIC	ISO 6162-1	METRIC FLANGE 1-1/4	FHV16-44/20 F	159	6.26	94.6	3.72	55	2.17	70	2.76	
25	1"	44/ METRIC	ISO 6162-1	METRIC FLANGE 1	FHV16-44/16 F	158	6.22	81.2	3.2	55	2.17	70	2.76	
25	1"	34/ SAE	ISO 6162-2	SAE FLANGE 1-1/4	FHV16-34/20 F	159	6.26	94.6	3.72	55	2.17	70	2.76	
25	1"	01/ METRIC	ISO 6149-2	M33x2 MALE	FHV16-1/3320 F	159	6.26	74	2.91	55	2.17	70	2.76	
25	1"	0/ SAE	ISO 11926-1	1-5/16"-12 UN FEMALE ORB	FHV16 1SAE F	138	5.43	74	2.91	55	2.17	70	2.76	
25	1"	F NPTF	ANSI B1.20.3	NPTF 1" FEMALE	FHV16 1NPT F	138	5.43	74	2.91	55	2.17	70	2.76	
25	1"	F NPTF	ANSI B1.20.3	NPTF 1-1/4" FEMALE	FHV16 114NPT F	138	5.43	74	2.91	55	2.17	70	2.76	
25	1"	F BSPP	ISO 1179-1	BSPP 1-1/4" FEMALE	FHV16 114GAS F	138	5.43	74	2.91	55	2.17	70	2.76	
25	1"	F BSPP	ISO 1179-1	BSPP 1" FEMALE	FHV16 1GAS F	138	5.43	74	2.91	55	2.17	70	2.76	
31.5	1-1/4"	76/ SAE	ISO 6162-2	SAE FLANGE HEAD 1-1/4	FHV20ET-76/20 F	207.2	8.16	74	2.91	55	2.17	70	2.76	
31.5	1-1/4"	71/ BSPP	JIS B 2351-1	BSPP 1-1/4 FEMALE ORB	FHV20ET-71/114GF	146.7	5.78	74	2.91	55	2.17	70	2.76	
31.5	1-1/4"	44/ METRIC	ISO 6162-1	METRIC FLANGE 1-1/4	FHV20ET-44A/20 F	167.2	6.58	74	2.91	-	-	70	2.76	
31.5	1-1/4"	44/ METRIC	ISO 6162-1	METRIC FLANGE 1-1/4	FHV20ET-44/20 F	167.2	6.58	74	2.91	-	-	70	2.76	
31.5	1-1/4"	F NPTF	ANSI B1.20.3	NPTF 1-1/4" FEMALE	FHV20ET 114NPT F	146.7	5.78	74	2.91	55	2.17	70	2.76	
31.5	1-1/4"	F BSPP	ISO 1179-1	BSPP 1-1/4" FEMALE	FHV20ET 114GAS F	146.7	5.78	74	2.91	60	2.36	70	2.76	
31.5	1-1/4"	F BSPP	ISO 1179-1	BSPP 1-1/2" FEMALE	FHV20ET 112GAS F	146.7	5.78	74	2.91	60	2.36	70	2.76	

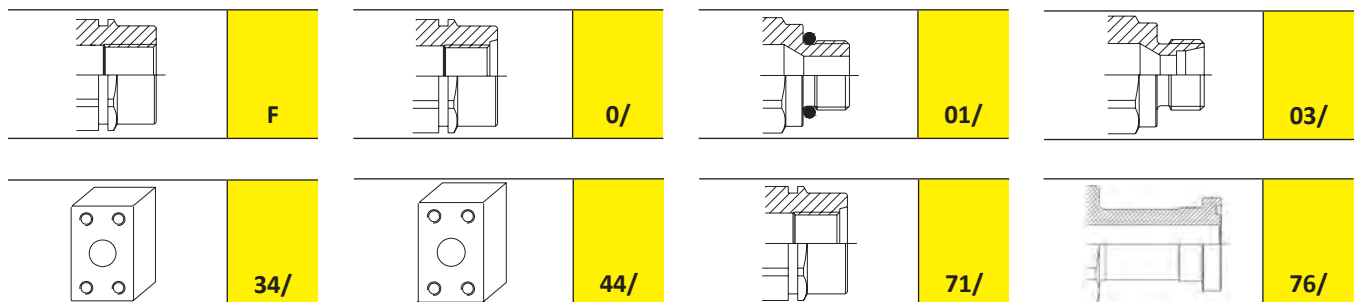

FHV

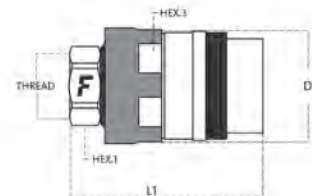

Size		Thread details			FEMALE									
mm	inch	Thread Type	Standard	Thread	Part Number	L (L1 + Thread)		D1		HEX1		HEX3		
						mm	inch	mm	inch	mm	inch	mm	inch	
37.5	1-1/2"	F BSPP	ISO 1179-1	BSPP 1-1/2" FEMALE	FHV24 112GAS F HD1*	170.4	6.71	95	3.74	65	2.56	95	3.74	
37.5	1-1/2"	76/ SAE	ISO 6162-2	SAE FLANGE HEAD 1-1/2	FHV24-76/24 F	236	9.29	100	3.94	65	2.56	95	3.74	
37.5	1-1/2"	76/ SAE	ISO 6162-2	SAE FLANGE HEAD 1-1/4	FHV24-76/20 F	226	8.9	100	3.94	65	2.56	95	3.74	
37.5	1-1/2"	44/ METRIC	ISO 6162-1	METRIC FLANGE 1-1/2	FHV24-44/24 F	192	7.56	113.3	4.46	65	2.56	95	3.74	
37.5	1-1/2"	34/ SAE	ISO 6162-2	SAE FLANGE 1-1/4	FHV24-34/20 F	181	7.13	94.6	3.72	65	2.56	95	3.74	
37.5	1-1/2"	0/ SAE	ISO 11926-1	1-5/8"-12 UN FEMALE ORB	FHV24 114SAE F	170.4	6.71	100	3.94	65	2.56	95	3.74	
37.5	1-1/2"	F NPTF	ANSI B1.20.3	NPTF 1-1/2" FEMALE	FHV24 112NPT F	170.4	6.71	100	3.94	65	2.56	95	3.74	
37.5	1-1/2"	44/ METRIC	ISO 6162-1	METRIC FLANGE 1-1/4	FHV24-44A/20 F	181	7.13	94.6	3.72	65	2.56	95	3.74	
37.5	1-1/2"	F BSPP	ISO 1179-1	BSPP 1-1/2" FEMALE	FHV24 112GAS F	170.4	6.71	100	3.94	65	2.56	95	3.74	
50	2"	71/ BSPP	JIS B 2351-1	BSPP 1-1/2" FEMALE ORB	FHV24-71/112G F	170.4	6.71	100	3.94	65	2.56	95	3.74	
50	2"	76/ SAE	ISO 6162-2	SAE FLANGE HEAD 2	FHV32-76/32 F	290.7	11.44	124	4.88	85	3.35	115	4.53	
50	2"	44/ METRIC	ISO 6162-1	METRIC FLANGE 2	FHV32-44/32 F	230.2	9.06	132.8	5.23	85	3.35	115	4.53	
50	2"	F NPTF	ANSI B1.20.3	NPTF 2" FEMALE	FHV32 2NPT F	200.2	7.88	124	4.88	85	3.35	115	4.53	

* Version with grease nipple and double bearing.

Flat Face

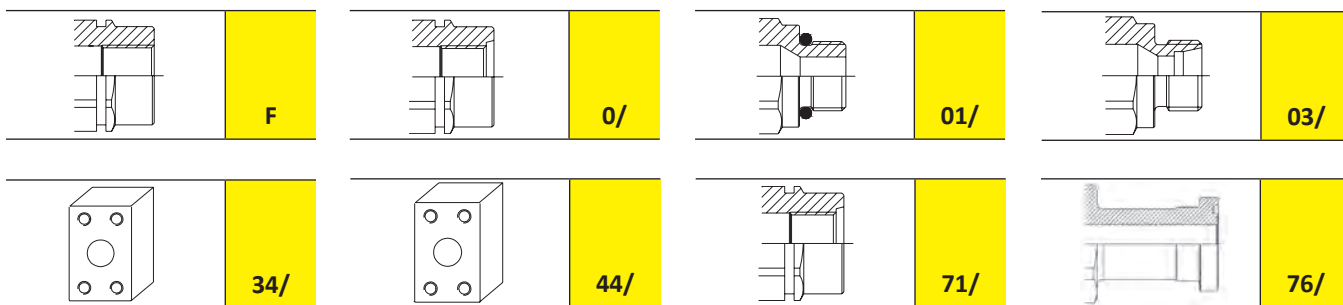



FHV

Size		Thread details			MALE									
mm	inch	Thread Type	Standard	Thread	Part Number	L (L1 + Thread)		D1		D3		HEX1		
						mm	inch	mm	inch	mm	inch	mm	inch	
10	3/8"	71/ BSPP	JIS B 2351-1	BSPP 3/8" FEMALE ORB	FHV06-71/38G M	96.8	3.81	33	1.3	23	0.91	36	1.42	
10	3/8"	F NPTF	ANSI B1.20.3	NPTF 3/8" FEMALE	FHV06 38NPT M	96.8	3.81	33	1.3	23	0.91	36	1.42	
10	3/8"	F BSPP	ISO 1179-1	BSPP 3/8" FEMALE	FHV06 38GAS M	96.8	3.81	33	1.3	23	0.91	36	1.42	
12.5	1/2"	71/ BSPP	JIS B 2351-1	BSPP 1/2 FEMALE ORB	FHV08-71/12G M	109.5	4.31	44.5	1.75	31	1.22	36	1.42	
12.5	1/2"	F BSPP	ISO 1179-1	BSPP 3/4" FEMALE	FHV08 34GAS M	109.5	4.31	44.5	1.75	31	1.22	36	1.42	
12.5	1/2"	F NPTF	ANSI B1.20.3	NPTF 1/2" FEMALE	FHV08 12NPT M	109.5	4.31	44.5	1.75	31	1.22	36	1.42	
12.5	1/2"	F BSPP	ISO 1179-1	BSPP 1/2" FEMALE	FHV08 12GAS M	109.5	4.31	44.5	1.75	31	1.22	36	1.42	
20	3/4"	0/ BSPP	BS 5380	BSPP 3/4 FEMALE ORB	FHV12-71/34G M	123.3	4.85	54.5	2.15	35	1.38	46	1.81	
20	3/4"	0/ SAE	ISO 11926-1	1-1/16"-12 UN FEMALE ORB	FHV12 34SAE M	122.5	4.82	54.5	2.15	35	1.38	46	1.81	
20	3/4"	F NPTF	ANSI B1.20.3	NPTF 3/4" FEMALE	FHV12 34NPT M	122.3	4.81	54.5	2.15	35	1.38	46	1.81	
20	3/4"	F BSPP	ISO 1179-1	BSPP 3/4" FEMALE	FHV12 34GAS M	122.5	4.82	54.5	2.15	35	1.38	46	1.81	
20	3/4"	F BSPP	ISO 1179-1	BSPP 1" FEMALE	FHV12 1GAS M	124.3	4.89	54.5	2.15	35	1.38	46	1.81	
25	1"	76/ SAE	ISO 6162-2	SAE FLANGE HEAD 1-1/4	FHV16-76/20 M	204.5	8.05	64	2.52	43.8	1.72	55	2.17	
25	1"	76/ SAE	ISO 6162-2	SAE FLANGE HEAD 1	FHV16-76/16 M	197.5	7.78	64	2.52	43.8	1.72	55	2.17	
25	1"	0/ BSPP	BS 5380	BSPP 1 FEMALE ORB	FHV16-71/1G M	143.8	5.66	64	2.52	43.8	1.72	55	2.17	
25	1"	44/ METRIC	ISO 6162-1	METRIC FLANGE 1-1/4	FHV16-44A/20 M	150.5	5.93	94.6	3.72	43.8	1.72	55	2.17	
25	1"	44/ METRIC	ISO 6162-1	METRIC FLANGE 1-1/4	FHV16-44/20 M	150.5	5.93	94.6	3.72	43.8	1.72	55	2.17	
25	1"	44/ METRIC	ISO 6162-1	METRIC FLANGE 1	FHV16-44/16 M	150.5	5.93	81.2	3.2	43.8	1.72	55	2.17	
25	1"	34/ SAE	ISO 6162-2	SAE FLANGE 1-1/4	FHV16-34/20 M	150.5	5.93	94.6	3.72	43.8	1.72	55	2.17	
25	1"	11/ SAE	ISO 8434-3	1-7/16"-12 UN MALE ORFS	FHV16-11/1S M	156	6.14	64	2.52	43.8	1.72	55	2.17	
25	1"	0/ SAE	ISO 11926-1	1-5/16"-12 UN FEMALE ORB	FHV16 1SAE M	143.8	5.66	64	2.52	43.8	1.72	55	2.17	
25	1"	F NPTF	ANSI B1.20.3	NPTF 1" FEMALE	FHV16 1NPT M	143.8	5.66	64	2.52	43.8	1.72	55	2.17	
25	1"	F BSPP	ISO 1179-1	BSPP 1-1/4" FEMALE	FHV16 114GAS M	143.8	5.66	64	2.52	43.8	1.72	55	2.17	
25	1"	F BSPP	ISO 1179-1	BSPP 1" FEMALE	FHV16 1GAS M	143.4	5.65	64	2.52	43.8	1.72	55	2.17	
31.5	1-1/4"	76/ SAE	ISO 6162-2	SAE FLANGE HEAD 1-1/4	FHV20ET-76/20 M	234.8	9.24	68	2.68	47.8	1.88	55	2.17	
31.5	1-1/4"	71/ BSPP	JIS B 2351-1	BSPP 1-1/4 FEMALE ORB	FHV20ET-71/114GM	165.8	6.53	68	2.68	47.8	1.88	55	2.17	
31.5	1-1/4"	44/ METRIC	ISO 6162-1	METRIC FLANGE 1-1/4	FHV20ET-44A/20 M	172.5	6.79	47.8	1.88	47.8	1.88	55	2.17	
31.5	1-1/4"	44/ METRIC	ISO 6162-1	METRIC FLANGE 1-1/4	FHV20ET-44/20 M	172.5	6.79	47.8	1.88	47.8	1.88	55	2.17	
31.5	1-1/4"	F BSPP	ISO 1179-1	BSPP 1-1/4" FEMALE	FHV20ET 114NPT M	165.8	6.53	68	2.68	47.8	1.88	55	2.17	
31.5	1-1/4"	F BSPP	ISO 1179-1	BSPP 1-1/4" FEMALE	FHV20ET 114GAS M	165.8	6.53	68	2.68	47.8	1.88	55	2.17	
31.5	1-1/4"	F BSPP	ISO 1179-1	BSPP 1-1/2" FEMALE	FHV20ET 112GAS M	165.8	6.53	68	2.68	47.8	1.88	60	2.36	
37.5	1-1/2"	44/ METRIC	ISO 6162-1	METRIC FLANGE 1-1/4	FHV24-44/20 M	188	7.4	85	3.35	68.9	2.71	75	2.95	
37.5	1-1/2"	76/ SAE	ISO 6162-2	SAE FLANGE HEAD 1-1/2	FHV24-76/24 M	247	9.72	84.5	3.33	68.9	2.71	75	2.95	
37.5	1-1/2"	76/ SAE	ISO 6162-2	SAE FLANGE HEAD 1-1/4	FHV24-76/20 M	247	9.72	84.5	3.33	68.9	2.71	75	2.95	
37.5	1-1/2"	44/ METRIC	ISO 6162-1	METRIC FLANGE 1-1/2	FHV24-44/24 M	197	7.76	113.3	4.46	68.9	2.71	75	2.95	
37.5	1-1/2"	34/ SAE	ISO 6162-2	SAE FLANGE 1-1/4	FHV24-34/20 M	185	7.28	94.6	3.72	68.9	2.71	75	2.95	

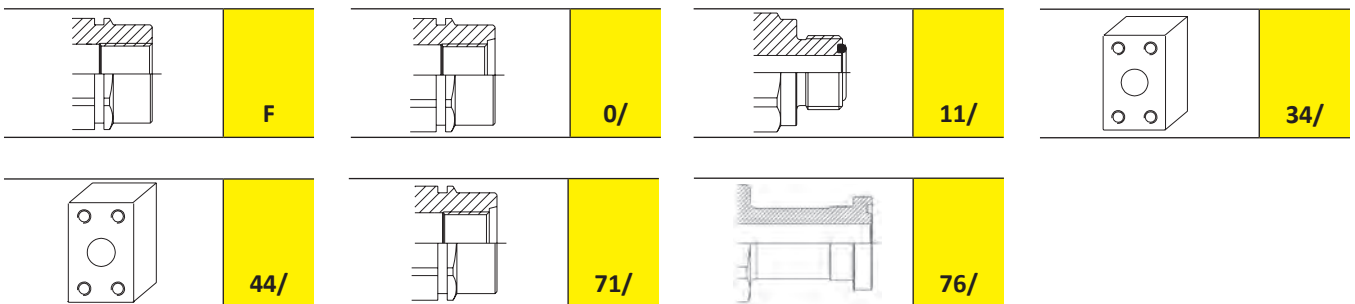

FHV

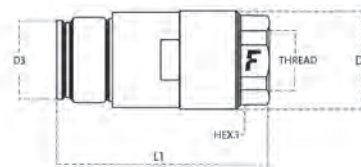

Size		Thread details			MALE									
mm	inch	Thread Type	Standard	Thread	Part Number	L (L1 + Thread)		D1		D3		HEX1		
						mm	inch	mm	inch	mm	inch	mm	inch	
37.5	1-1/2"	O/ SAE	ISO 11926-1	1-5/8"-12 UN FEMALE ORB	FHV24 114SAE M	187.1	7.37	84.5	3.33	68.9	2.71	75	2.95	
37.5	1-1/2"	F NPTF	ANSI B1.20.3	NPTF 1-1/2" FEMALE	FHV24 112NPT M	187.1	7.37	84.5	3.33	68.9	2.71	75	2.95	
37.5	1-1/2"	44/ METRIC	ISO 6162-1	METRIC FLANGE 1-1/4	FHV24-44A/20 M	185	7.28	94.6	3.72	68.9	2.71	75	2.95	
37.5	1-1/2"	F BSPP	ISO 1179-1	BSPP 1-1/2" FEMALE	FHV24 112GAS M	187.1	7.37	84.5	3.33	68.9	2.71	75	2.95	
50	2"	71/ BSPP	JIS B 2351-1	BSPP 1-1/2" FEMALE ORB	FHV24-71/112G M	187	7.36	84.5	3.33	68.9	2.71	75	2.95	
50	2"	76/ SAE	ISO 6162-2	SAE FLANGE HEAD 2	FHV32-76/32 M	332	13.07	115	4.53	84.9	3.34	85	3.35	
50	2"	44/ METRIC	ISO 6162-1	METRIC FLANGE 2	FHV32-44/32 M	253	9.96	132.8	5.23	84.9	3.34	85	3.35	
50	2"	F NPTF	ANSI B1.20.3	NPTF 2" FEMALE	FHV32 2NPT M	237	9.33	115	4.53	84.9	3.34	85	3.35	

Flat Face

FHV Accessories and Spares



PVC dust protections

page 243



Aluminium dust protections

page 252



Seals Kits

page 262

	F		O/		11/		34/
	44/		71/		76/		

FHV IP



Screw to connect flat face coupling - Ingress Protection.

The only screw to connect coupling certified Ingress Protection 54 (IP54). Female screw-on flat face couplings, suitable to construction equipment and heavy duty applications. The Zinc-Nickel plating guarantees a remarkable resistance to corrosion. Connectable by hand up to 35 MPa residual pressure in the male half. No hose torsion during connection and disconnection thanks to the internal bearing system. Equipped with a safety sleeve to prevent accidental disconnections due to vibrations. Aluminum and pvc dust caps available. Faster proprietary profile. Extended Temperature range (from -30° to 120 ° C) in connected configuration. To be connected with FHV ET and FHV K male coupler.



Applications



Pressure Drop

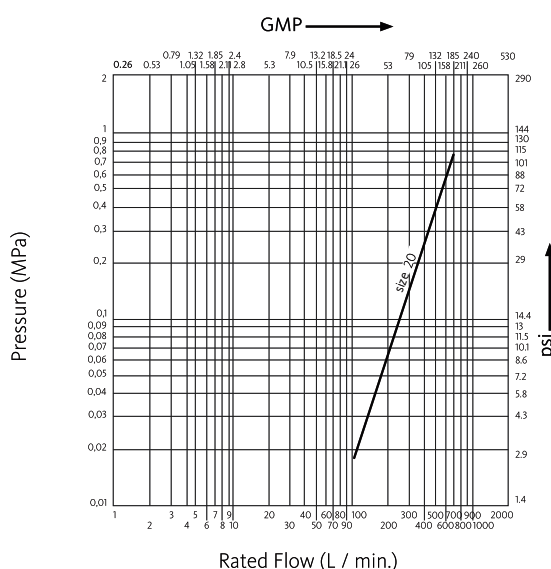

Test performed according to ISO 18869

Technical Specifications

dash	Size		Working Pressure (MPa)	Flow Rate (l/min)	Spillage (ml)	Force to Connect (N)	Burst pressure (MPa)		
	mm	inch					Male	Female	Male + Female
20	31.5	1-1/4"	46	380	0.03		140		160

Material	Steel
Seals	FKM & PUR
Working temperatures	-20 °C to 100 °C
Surface treatment	MATE 1000 (ZnNi)
Series Interchange	FASTER

Valve Type	Flat
Connection	Screw to Connect
Disconnection	Unscrew to Disconnect
Connection Under Pressure	Allowed Male Half up to W.P.



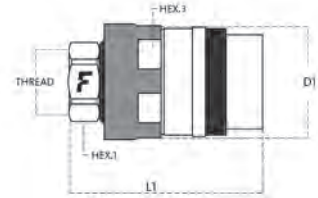

FHV IP

Size		Thread details			FEMALE								
mm	inch	Thread Type	Standard	Thread	Part Number	L (L1 + Thread)		D1		HEX1		HEX3	
						mm	inch	mm	inch	mm	inch	mm	inch
31.5	1-1/4"	08/ METRIC	ISO 8434-1-S	M52X2 MALE BULKHEAD SHORT 38S	FHV20IP-8/5220 F	189.7	7.47	74	2.91	60	2.36	70	2.76
31.5	1-1/4"	76/ SAE	ISO 6162-2	SAE FLANGE HEAD 1-1/4	FHV20IP-76/20 F	207.2	8.16	74	2.91	55	2.17	70	2.76
31.5	1-1/4"	71/ BSPP	JIS B 2351-1	BSPP 1 FEMALE ORB	FHV20IP-71/1GF	146.7	5.78	74	2.91	55	2.17	70	2.76
31.5	1-1/4"	71/ BSPP	JIS B 2351-1	BSPP 1-1/4 FEMALE ORB	FHV20IP-71/114GF	146.7	5.78	74	2.91	55	2.17	70	2.76
31.5	1-1/4"	44/ METRIC	ISO 6162-1	METRIC FLANGE 1-1/4	FHV20IP-44A/20 F	167.2	6.58	74	2.91	-	-	70	2.76
31.5	1-1/4"	44/ METRIC	ISO 6162-1	METRIC FLANGE 1-1/4	FHV20IP-44/20 F	167.2	6.58	74	2.91	-	-	70	2.76
31.5	1-1/4"	03/ METRIC	ISO 8434-1-S	M42x2 MALE 30S	FHV20IP-3/4220 F	166.7	6.56	74	2.91	55	2.17	70	2.76
31.5	1-1/4"	F NPTF	ANSI B1.20.3	NPTF 1-1/4" FEMALE	FHV20IP 114NPT F	146.7	5.78	74	2.91	55	2.17	70	2.76
31.5	1-1/4"	F BSPP	ISO 1179-1	BSPP 1-1/4" FEMALE	FHV20IP 114GAS F	146.7	5.78	74	2.91	55	2.17	70	2.76
31.5	1-1/4"	F BSPP	ISO 1179-1	BSPP 1-1/2" FEMALE	FHV20IP 112GAS F	146.7	5.78	74	2.91	60	2.36	70	2.76
31.5	1-1/4"	F BSPP	ISO 1179-1	BSPP 1-1/2" FEMALE	FHV20ET 112GAS F	146.7	5.78	74	2.91	60	2.36	70	2.76

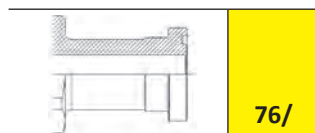
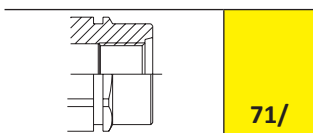
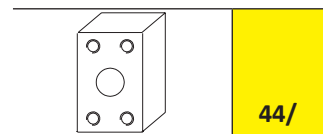
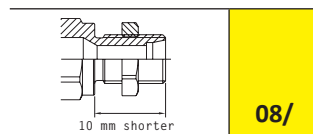
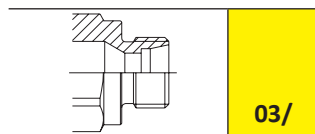
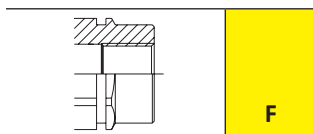

FHV K



Compact FHV screw to connect flat face coupling.

Compact version of Faster FHV series. Male Compact screw-on flat face couplings, suitable to construction equipment and heavy duty applications. The Zinc-Nickel plating guarantees a remarkable resistance to corrosion. No hose torsion during connection and disconnection thanks to the internal bearing system. Equipped with a safety sleeve to prevent accidental disconnections due to vibrations. Aluminum and pvc dust caps available. Faster proprietary profile. Extended Temperature range (from -30° to 120 °C) in connected configuration.



Applications



Pressure Drop

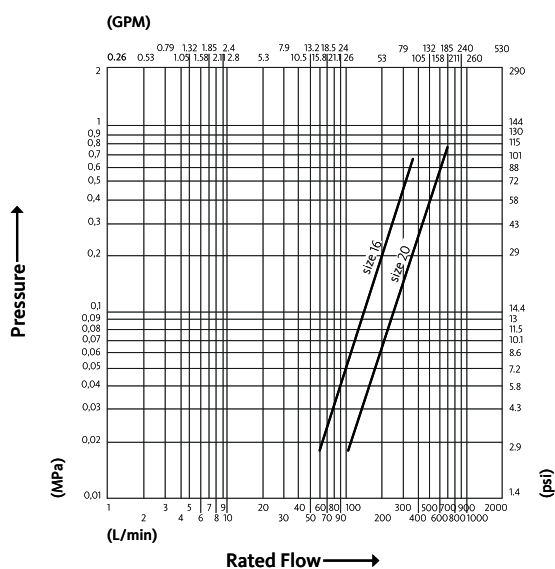

Test performed according to ISO 18869

Technical Specifications

dash	Size		Working Pressure (MPa)	Flow Rate (l/min)	Spillage (ml)	Force to Connect (N)	Burst pressure (MPa)		
	mm	inch					Male	Female	Male + Female
16	25	1"	46	240	0.03		140		160
20	31.5	1-1/4"	46	380	0.03		140		160

Material	Steel
Seals	FKM & PUR
Working temperatures	-20 °C to 100 °C
Surface treatment	MATE 1000 (ZnNi)
Series Interchange	FASTER

Valve Type	Flat
Connection	Screw to Connect
Disconnection	Unscrew to Disconnect
Connection Under Pressure	Not Allowed





FHV K

Size		Thread details			MALE									
mm	inch	Thread Type	Standard	Thread	Part Number	L (L1 + Thread)		D1		D3		HEX1		
						mm	inch	mm	inch	mm	inch	mm	inch	
25	1"	08/ METRIC	ISO 8434-1-S	M42X2 MALE BULKHEAD SHORT 30S	FHVK16-8/4220 M	150.7	5.93	64	2.52	43.8	1.72	55	2.17	
31.5	1-1/4"	08/ METRIC	ISO 8434-1-S	M52X2 MALE BULKHEAD SHORT 38S	FHVK20-8/5220 M	168	6.61	73	2.87	47.8	1.88	60	2.36	
31.5	1-1/4"	F NPTF	ANSI B1.20.3	NPTF 1-1/4" FEMALE	FHVK20 114NPT M	125	4.92	68	2.68	47.8	1.88	55	2.17	

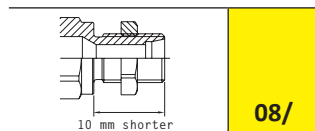
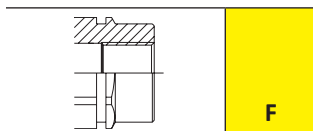

Screw to Connect

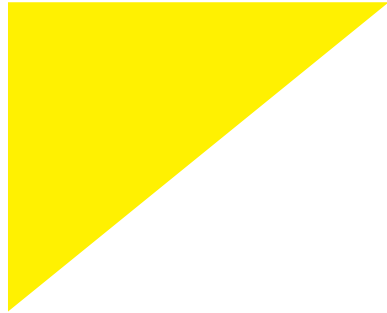

Screw to connect couplings, specifically designed to resist vibrations.

CVV	page 159
CVLS	page 165
CVC	page 167
CVE	page 171
VV	page 173
VVS	page 177
VVS stainless steel	page 181
VVM	page 185
FB	page 187
OGV	page 189
OGVST	page 191
Couplings Accessories	page 242

CVV



Screw to connect couplings, ISO 14541 interchange.

Screw-on couplings suitable for general purpose applications. Connectable under residual pressure. High resistance to pressure and flow impulses. Interchangeable according to ISO 14541 standard for size: 1/4"; 3/8"; 1/2"; 3/4".



Applications



Pressure Drop

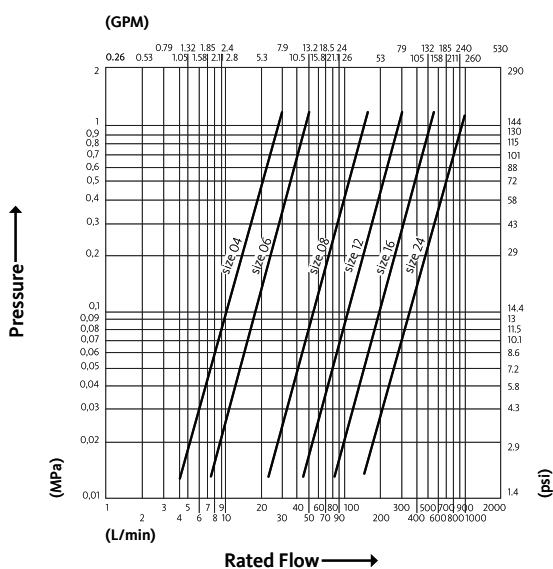

Test performed according to ISO 18869

Technical Specifications

dash	Size mm	inch	Working Pressure* (MPa)	Flow Rate (l/min)	Spillage (ml)	Force to Connect (N)	Burst pressure (MPa)		
							Male	Female	Male + Female
04	6.3	1/4"	37	13	0.8	0	150	160	190
06	10	3/8"	30	25	1.3	0	120	130	170
08	12.5	1/2"	30	65	1.8	0	120	140	140
12	20	3/4"	27	100	8	0	110	120	130
16	25	1"	27	205	13	0	110	130	140
24	37.5	1-1/2"	27	450	34	0	110	110	100

* Working Pressure according to ISO 14541, that requires a safety factor 4:1 on Minimum Burst Pressure. The coupling can perfectly work with a safety factor 3:1 and consequently with higher Working Pressure.

Material	Steel
Seals	NBR; VITON**
Working temperatures	- 25 °C to + 125 °C
Surface treatment	MATE 500 (CrIII)
Series Interchange	MARKET; ISO 14541

Valve Type	Poppet
Connection	Screw to Connect
Disconnection	Unscrew to Disconnect
Connection Under Pressure	Allowed Residual



** Working temperatures: - 20 °C to + 200 °C

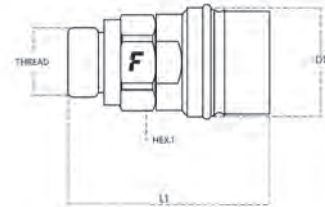

Size		Thread details			FEMALE						
mm	inch	Thread Type	Standard	Thread	Part Number	L (L1 + Thread)		D1		HEX1	
						mm	inch	mm	inch	mm	inch
6.3	1/4"	07/ METRIC	ISO 8434-1-L	M18x1.5 MALE BULKHEAD SHORT 12L	CVV047/1815 F	74	2.91	24	0.94	22	0.87
6.3	1/4"	07/ METRIC	ISO 8434-1-L	M14x1.5 MALE BULKHEAD SHORT 8L	CVV047/1415 F	74	2.91	24	0.94	19	0.75
6.3	1/4"	07/ METRIC	ISO 8434-1-L	M12x1.5 MALE BULKHEAD SHORT 6L	CVV047/1215 F	74	2.91	24	0.94	19	0.75
6.3	1/4"	27/ SAE	ISO 8434-3	9/16"-18 UNF FEMALE	CVV0427/14SAEF	62	2.44	24	0.94	19	0.75
6.3	1/4"	12/ SAE	ISO 8434-3	13/16"-16 UN MALE BULKHEAD ORFS	CVV0412/12S F	82.5	3.25	24	0.94	24	0.94
6.3	1/4"	F BSPP	ISO 1179-1	BSPP 1/4" FEMALE	CVV04 14 GAS F	63	2.48	24	0.94	19	0.75
10	3/8"	05/ METRIC	ISO 8434-1-L	M16x1.5 MALE BULKHEAD 10L	CVV065/1615 F	92	3.62	28	1.1	24	0.94
10	3/8"	02/ METRIC	ISO 8434-1-L	M16x1.5 MALE 10L	CVV062/1615 F	68	2.68	28	1.1	24	0.94
10	3/8"	F BSPP	ISO 1179-1	BSPP 3/8" FEMALE	CVV06 38 GAS F	71	2.8	28	1.1	24	0.94
12.5	1/2"	07/ METRIC	ISO 8434-1-L	M22x1.5 MALE BULKHEAD SHORT 15L	CVV087/2215 FV	72	2.83	36	1.42	27	1.06
12.5	1/2"	07/ METRIC	ISO 8434-1-L	M18x1.5 MALE BULKHEAD SHORT 12L	CVV087/1815 FV	72	2.83	36	1.42	27	1.06
12.5	1/2"	06/ METRIC	ISO 8434-1-S	M24x1.5 MALE BULKHEAD 16S	CVV086/2415 FV	81	3.19	36	1.42	27	1.06
12.5	1/2"	05/ METRIC	ISO 8434-1-L	M26x1.5 MALE BULKHEAD 18L	CVV085/2615 FV	81	3.19	40	1.57	27	1.06
12.5	1/2"	05/ METRIC	ISO 8434-1-L	M22x1.5 MALE BULKHEAD 15L	CVV085/2215 FV	81	3.19	36	1.42	27	1.06
12.5	1/2"	05/ METRIC	ISO 8434-1-L	M18x1.5 MALE BULKHEAD 12L	CVV085/1815 FV	81	3.19	36	1.42	27	1.06
12.5	1/2"	05/ METRIC	ISO 8434-1-L	M16x1.5 MALE BULKHEAD 10L	CVV085/1615 FV	81	3.19	36	1.42	27	1.06
12.5	1/2"	03/ METRIC	ISO 8434-1-S	M24x1.5 MALE 16S	CVV083/2415 FV	60	2.36	36	1.42	27	1.06
12.5	1/2"	03/ METRIC	ISO 8434-1-S	M22x1.5 MALE 14S	CVV083/2215 FV	60	2.36	36	1.42	27	1.06
12.5	1/2"	03/ METRIC	ISO 8434-1-S	M20x1.5 MALE 12S	CVV083/2015 FV	58	2.28	36	1.42	27	1.06
12.5	1/2"	27/ SAE	ISO 8434-3	1"-14 UNS FEMALE ORFS	CVV0827/58SAEFV	64	2.52	36	1.42	30	1.18
12.5	1/2"	02/ METRIC	ISO 8434-1-L	M26x1.5 MALE 18L	CVV082/2615 FV	58	2.28	36	1.42	27	1.06
12.5	1/2"	02/ METRIC	ISO 8434-1-L	M22x1.5 MALE 15L	CVV082/2215 FV	58	2.28	36	1.42	27	1.06
12.5	1/2"	02/ METRIC	ISO 8434-1-L	M18x1.5 MALE 12L	CVV082/1815 FV	57	2.24	36	1.42	27	1.06
12.5	1/2"	02/ METRIC	ISO 8434-1-L	M16x1.5 MALE 10L	CVV082/1615 FV	59	2.32	36	1.42	27	1.06
12.5	1/2"	0/ BSPP	BS 5380	BSPP 3/8 FEMALE ORB	CVV080/38GAS FV	57	2.24	36	1.42	27	1.06
12.5	1/2"	0/ METRIC	ISO 6149-1	M22x1.5 FEMALE ORB	CVV080/2215 FV	61	2.4	36	1.42	27	1.06
12.5	1/2"	0/ SAE	ISO 11926-1	3/4"-16 UNF FEMALE ORB	CVV080/12SAE FV	61	2.4	36	1.42	27	1.06
12.5	1/2"	0/ BSPP	BS 5380	BSPP 1/2 FEMALE ORB	CVV080/12GAS FV	61	2.4	36	1.42	27	1.06
12.5	1/2"	F BSPP	ISO 1179-1	BSPP 3/8" FEMALE	CVV08 38 GAS FV	57	2.24	36	1.42	27	1.06
12.5	1/2"	F BSPP	ISO 1179-1	BSPP 1/2" FEMALE	CVV08 12 GAS FV	61	2.4	36	1.42	27	1.06
20	3/4"	F BSPP	ISO 1179-1	BSPP 3/4" FEMALE	CVV12 34 GAS FV	83	3.27	42	1.65	38	1.5
20	3/4"	0/ SAE	ISO 11926-1	1-1/16"-12 UN FEMALE ORB	CVV120/34SAE FV	83	3.27	42	1.65	38	1.5
25	1"	06/ METRIC	ISO 8434-1-S	M42x2 MALE BULKHEAD 30S	CVV166/422 F V	110	4.33	56	2.2	50	1.97
25	1"	06/ METRIC	ISO 8434-1-S	M36x2 MALE BULKHEAD 25S	CVV166/362 F V	113	4.45	52	2.05	42	1.65
25	1"	06/ METRIC	ISO 8434-1-S	M30x2 MALE BULKHEAD 20S	CVV166/302 F V	114	4.49	48	1.89	38	1.5
25	1"	05/ METRIC	ISO 8434-1-L	M36x2 MALE BULKHEAD 28L	CVV165/362 F V	106	4.17	52	2.05	42	1.65
25	1"	05/ METRIC	ISO 8434-1-L	M30x2 MALE BULKHEAD 22L	CVV165/302 F V	109	4.29	48	1.89	41	1.61
25	1"	03/ METRIC	ISO 8434-1-S	M42x2 MALE 30S	CVV163/422 F V	90	3.54	51	2.01	46	1.81
25	1"	03/ METRIC	ISO 8434-1-S	M36x2 MALE 25S	CVV163/362 F V	93	3.66	48	1.89	38	1.5
25	1"	03/ METRIC	ISO 8434-1-S	M30x2 MALE 20S	CVV163/302 F V	92	3.62	48	1.89	38	1.5
25	1"	02/ METRIC	ISO 8434-1-L	M36x2 MALE 28L	CVV162/362 F V	87	3.43	48	1.89	38	1.5
25	1"	11/ SAE	ISO 8434-3	1-7/16"-12 UN MALE ORFS	CVV1611/1SAE FV	96	3.78	55	2.17	50	1.97
25	1"	11/ SAE	ISO 8434-3	1-11/16"-12 UN MALE ORFS	CVV1611/114S FV	96	3.78	55	2.17	50	1.97
25	1"	0/ BSPP	BS 5380	BSPP 3/4 FEMALE ORB	CVV160/34GASFV	90	3.54	48	1.89	38	1.5
25	1"	0/ BSPP	BS 5380	BSPP 1 FEMALE ORB	CVV160/1GAS FV	93	3.66	48	1.89	42	1.65
25	1"	F BSPP	ISO 1179-1	BSPP 3/4" FEMALE	CVV16 34 GAS FV	89	3.5	48	1.89	38	1.5

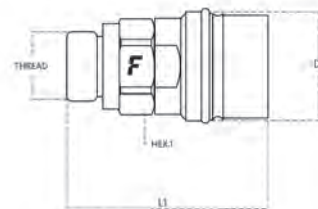

CVV

Size		Thread details			FEMALE						
mm	inch	Thread Type	Standard	Thread	Part Number	L (L1 + Thread)		D1		HEX1	
						mm	inch	mm	inch	mm	inch
25	1"	F BSPP	ISO 1179-1	BSPP 1" FEMALE	CVV16 1 GAS FV	94	3.7	46	1.81	42	1.65
37.5	1-1/2"	06/ METRIC	ISO 8434-1-S	M52x2 MALE BULKHEAD 38S	CVV246/522 F V	137	5.39	73	2.87	55	2.17
37.5	1-1/2"	06/ METRIC	ISO 8434-1-S	M42x2 MALE BULKHEAD 30S	CVV246/422 F V	135	5.31	70	2.76	55	2.17
37.5	1-1/2"	05/ METRIC	ISO 8434-1-L	M45x2 MALE BULKHEAD 35L	CVV245/452 F V	131	5.16	70	2.76	55	2.17
37.5	1-1/2"	03/ METRIC	ISO 8434-1-S	M52x2 MALE 38S	CVV243/522 F V	117	4.61	70	2.76	55	2.17
37.5	1-1/2"	03/ METRIC	ISO 8434-1-S	M42x2 MALE 30S	CVV243/422 F V	115	4.53	70	2.76	55	2.17
37.5	1-1/2"	02/ METRIC	ISO 8434-1-L	M45x2 MALE 35L	CVV242/452 F V	111	4.37	70	2.76	55	2.17
37.5	1-1/2"	F BSPP	ISO 1179-1	BSPP 1-1/2" FEMALE	CVV24 112GAS FV	121	4.76	72	2.83	65	2.56

Part numbers ending in V have seals in FKM and consequently a Working Temperature of -20 °C + 200 °C.

Screw to Connect

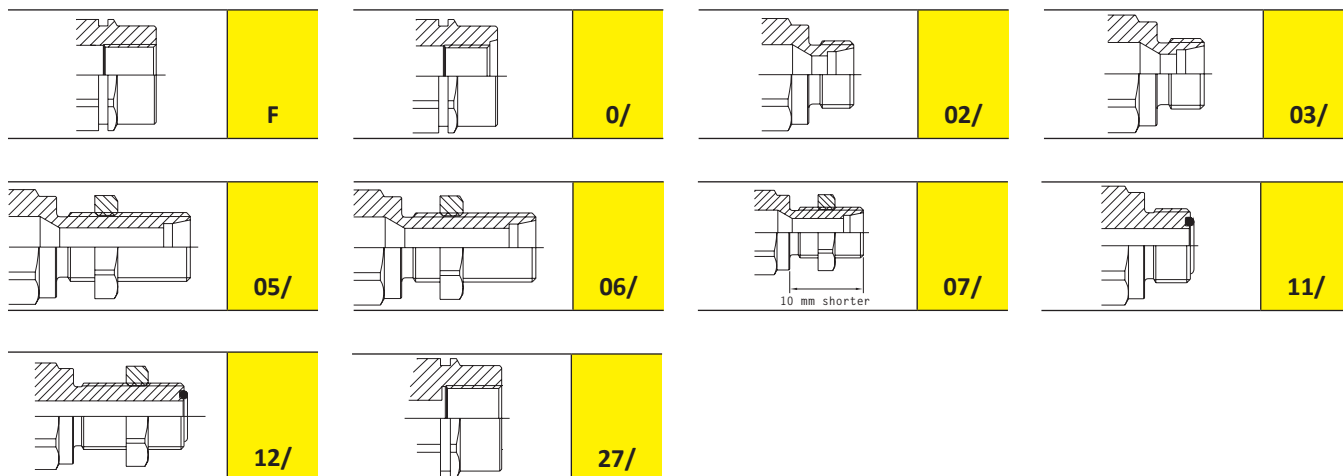

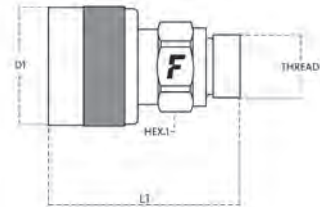

CVV

Size		Thread details			MALE								
mm	inch	Thread Type	Standard	Thread	Part Number	L (L1 + Thread)		D1		D3		HEX1	
						mm	inch	mm	inch	mm	inch	mm	inch
6.3	1/4"	27/ SAE	ISO 8434-3	9/16"-18 UNF FEMALE	CVV0427/14SAEM	62	2.44	30	1.18			19	0.75
6.3	1/4"	02/ METRIC	ISO 8434-1-L	M18x1.5 MALE 12L	CVV042/1815 M	59	2.32	30	1.18			22	0.87
6.3	1/4"	02/ METRIC	ISO 8434-1-L	M14x1.5 MALE 8L	CVV042/1415 M	58	2.28	30	1.18			19	0.75
6.3	1/4"	02/ METRIC	ISO 8434-1-L	M12x1.5 MALE 6L	CVV042/1215 M	58	2.28	30	1.18			19	0.75
6.3	1/4"	11/ SAE	ISO 8434-3	13/16"-16 UN MALE ORFS	CVV0411/12S M	61	2.4	30	1.18			22	0.87
6.3	1/4"	F BSPP	ISO 1179-1	BSPP 1/4" FEMALE	CVV04 14 GAS M	63	2.48	30	1.18			19	0.75
10	3/8"	02/ METRIC	ISO 8434-1-L	M18x1.5 MALE 12L	CVV062/1815 M	68	2.68	34	1.34			24	0.94
10	3/8"	02/ METRIC	ISO 8434-1-L	M16x1.5 MALE 10L	CVV062/1615 M	66	2.6	34	1.34			24	0.94
10	3/8"	F BSPP	ISO 1179-1	BSPP 3/8" FEMALE	CVV06 38 GAS M	70	2.76	34	1.34			24	0.94
12.5	1/2"	07/ METRIC	ISO 8434-1-L	M22x1.5 MALE BULKHEAD SHORT 15L	CVV087/2215 MV	81	3.19	42	1.65			27	1.06
12.5	1/2"	07/ METRIC	ISO 8434-1-L	M18x1.5 MALE BULKHEAD SHORT 12L	CVV087/1815 MV	81	3.19	42	1.65			27	1.06
12.5	1/2"	06/ METRIC	ISO 8434-1-S	M24x1.5 MALE BULKHEAD 16S	CVV086/2415 MV	90	3.54	42	1.65			27	1.06
12.5	1/2"	06/ METRIC	ISO 8434-1-S	M22x1.5 MALE BULKHEAD 14S	CVV086/2215 MV	90	3.54	42	1.65			27	1.06
12.5	1/2"	05/ METRIC	ISO 8434-1-L	M22x1.5 MALE BULKHEAD 15L	CVV085/2215 MV	90	3.54	42	1.65			27	1.06
12.5	1/2"	05/ METRIC	ISO 8434-1-L	M18x1.5 MALE BULKHEAD 12L	CVV085/1815 MV	90	3.54	42	1.65			27	1.06
12.5	1/2"	03/ METRIC	ISO 8434-1-S	M24x1.5 MALE 16S	CVV083/2415 MV	69	2.72	42	1.65			27	1.06
12.5	1/2"	03/ METRIC	ISO 8434-1-S	M22x1.5 MALE 14S	CVV083/2215 MV	69	2.72	42	1.65			27	1.06
12.5	1/2"	03/ METRIC	ISO 8434-1-S	M20x1.5 MALE 12S	CVV083/2015 MV	67	2.64	42	1.65			27	1.06
12.5	1/2"	27/ SAE	ISO 8434-3	1"-14 UNS FEMALE ORFS	CVV0827/58SAEMV	73	2.87	42	1.65			30	1.18
12.5	1/2"	02/ METRIC	ISO 8434-1-L	M26x1.5 MALE 18L	CVV082/2615 MV	67	2.64	42	1.65			27	1.06
12.5	1/2"	02/ METRIC	ISO 8434-1-L	M22x1.5 MALE 15L	CVV082/2215 MV	67	2.64	42	1.65			27	1.06
12.5	1/2"	02/ METRIC	ISO 8434-1-L	M18x1.5 MALE 12L	CVV082/1815 MV	66	2.6	42	1.65			27	1.06
12.5	1/2"	02/ METRIC	ISO 8434-1-L	M16x1.5 MALE 10L	CVV082/1615 MV	67	2.64	42	1.65			27	1.06
12.5	1/2"	0/ BSPP	BS 5380	BSPP 3/8 FEMALE ORB	CVV080/38GAS MV	66	2.6	42	1.65			27	1.06
12.5	1/2"	0/ METRIC	ISO 6149-1	M22x1.5 FEMALE ORB	CVV080/2215 MV	70	2.76	42	1.65			27	1.06
12.5	1/2"	0/ SAE	ISO 11926-1	3/4"-16 UNF FEMALE ORB	CVV080/12SAE MV	70	2.76	42	1.65			27	1.06
12.5	1/2"	0/ BSPP	BS 5380	BSPP 1/2 FEMALE ORB	CVV080/12GAS MV	70	2.76	42	1.65			27	1.06
12.5	1/2"	F BSPP	ISO 1179-1	BSPP 3/8" FEMALE	CVV08 38 GAS MV	66	2.6	42	1.65			27	1.06
12.5	1/2"	F BSPP	ISO 1179-1	BSPP 1/2" FEMALE	CVV08 12 GAS MV	70	2.76	42	1.65			27	1.06
20	3/4"	0/ SAE	ISO 11926-1	1-1/16"-12 UN FEMALE ORB	CVV120/34SAE MV	86	3.39	48	1.89			38	1.5
20	3/4"	F BSPP	ISO 1179-1	BSPP 3/4" FEMALE	CVV12 34 GAS MV	86	3.39	48	1.89			38	1.5
25	1"	06/ METRIC	ISO 8434-1-S	M42x2 MALE BULKHEAD 30S	CVV166/422 M V	110	4.33	56	2.2			50	1.97
25	1"	06/ METRIC	ISO 8434-1-S	M36x2 MALE BULKHEAD 25S	CVV166/362 M V	113	4.45	56	2.2			42	1.65
25	1"	06/ METRIC	ISO 8434-1-S	M30x2 MALE BULKHEAD 20S	CVV166/302 M V	115	4.53	56	2.2			38	1.5
25	1"	05/ METRIC	ISO 8434-1-L	M36x2 MALE BULKHEAD 28L	CVV165/362 M V	107	4.21	56	2.2			42	1.65
25	1"	03/ METRIC	ISO 8434-1-S	M42x2 MALE 30S	CVV163/422 M V	90	3.54	56	2.2			38	1.5
25	1"	03/ METRIC	ISO 8434-1-S	M30x2 MALE 20S	CVV163/302 M V	93	3.66	56	2.2			38	1.5
25	1"	02/ METRIC	ISO 8434-1-L	M36x2 MALE 28L	CVV162/362 M V	88	3.46	56	2.2			38	1.5
25	1"	02/ METRIC	ISO 8434-1-L	M30x2 MALE 22L	CVV162/302 M V	89	3.5	56	2.2			38	1.5
25	1"	11/ SAE	ISO 8434-3	1-7/16"-12 UN MALE ORFS	CVV1611/1SAE MV	97	3.82	56	2.2			50	1.97
25	1"	11/ SAE	ISO 8434-3	1-11/16"-12 UN MALE ORFS	CVV1611/114S MV	97	3.82	56	2.2			50	1.97
25	1"	0/ BSPP	BS 5380	BSPP 3/4 FEMALE ORB	CVV160/34GAS MV	90	3.54	56	2.2			38	1.5
25	1"	0/ BSPP	BS 5380	BSPP 1 FEMALE ORB	CVV160/1GAS MV	49	1.93	56	2.2			42	1.65
25	1"	0/ SAE	ISO 11926-1	1-3/16"-12 UN FEMALE ORB	CVV16 78S M V	93	3.66	56	2.2			42	1.65

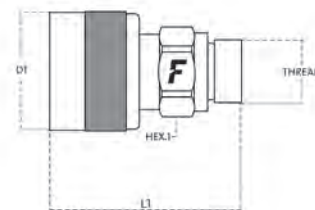

CVV

Size		Thread details			MALE								
mm	inch	Thread Type	Standard	Thread	Part Number	L (L1 + Thread)		D1		D3		HEX1	
						mm	inch	mm	inch	mm	inch	mm	inch
25	1"	03/ METRIC	ISO 8434-1-S	M36x2 MALE 25S	CVV163/362 M V	93	3.66	56	2.2			38	1.5
25	1"	F BSPP	ISO 1179-1	BSPP 3/4" FEMALE	CVV16 34 GAS MV	90	3.54	56	2.2			38	1.5
25	1"	F BSPP	ISO 1179-1	BSPP 1" FEMALE	CVV16 1 GAS MV	95	3.74	56	2.2			42	1.65
37.5	1-1/2"	06/ METRIC	ISO 8434-1-S	M52x2 MALE BULKHEAD 38S	CVV246/522 M V	147	5.79	80	3.15			55	2.17
37.5	1-1/2"	03/ METRIC	ISO 8434-1-S	M52x2 MALE 38S	CVV243/522 M V	127	5	80	3.15			55	2.17
37.5	1-1/2"	03/ METRIC	ISO 8434-1-S	M42x2 MALE 30S	CVV243/422 M V	125	4.92	80	3.15			55	2.17
37.5	1-1/2"	F BSPP	ISO 1179-1	BSPP 1-1/2" FEMALE	CVV24 112GAS MV	131	5.16	80	3.15			65	2.56

Part numbers ending in V have seals in FKM and consequently a Working Temperature of -20 °C + 200 °C.

Screw to Connect

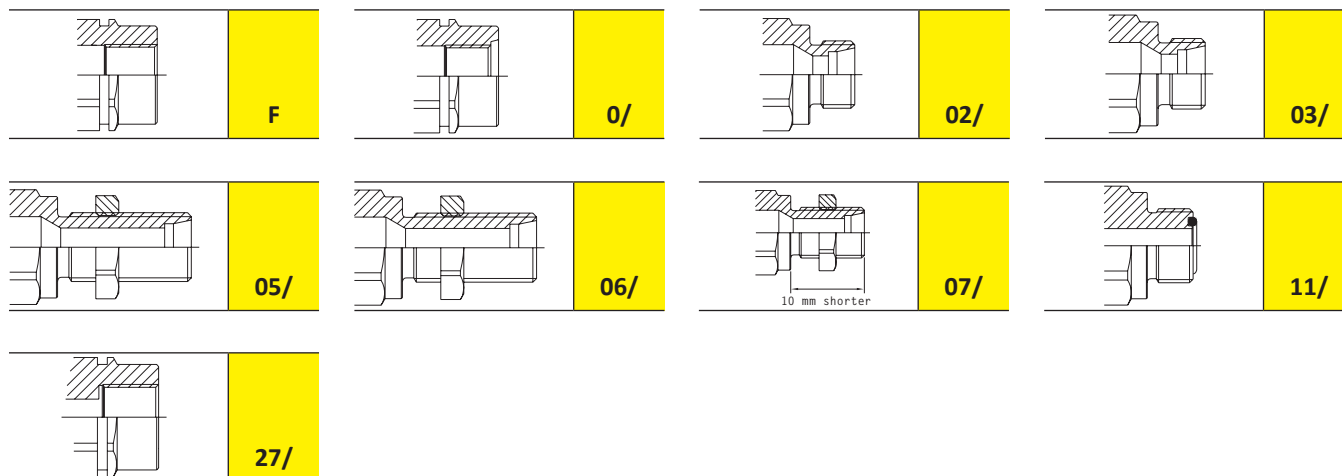

CVV Accessories and Spares

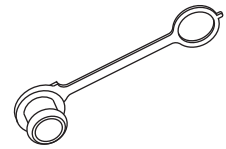
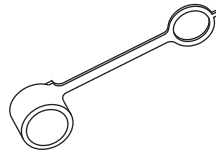

Plastic dust protections

page 249

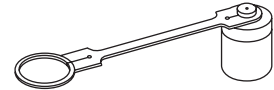
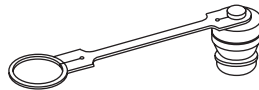

Aluminium dust protections

page 252

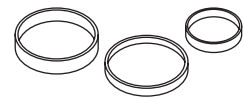

Seals Kits

page 262



CVLS

Screw-to-connect couplings, safety sleeve.

Screw-on male couplings suitable for general purpose applications. Connectable under residual pressure. High resistance to pressure and flow impulses. Equipped with an additional safety sleeve to prevent accidental disconnections provoked by vibrations. Interchangeable according to ISO 14541 standard.



Applications



Pressure Drop

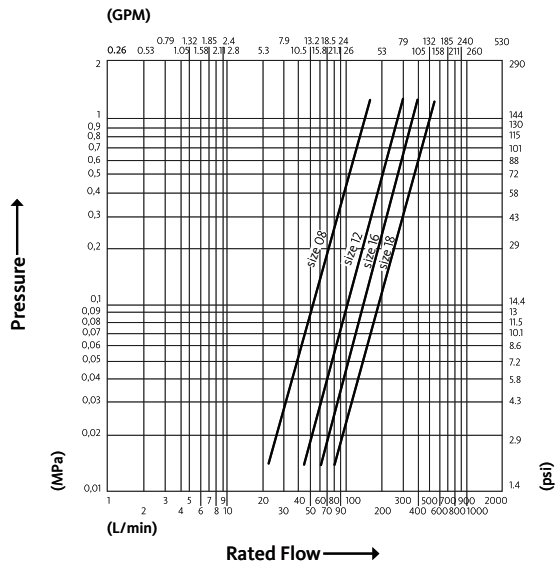

Test performed according to ISO 18869

Technical Specifications

dash	Size		Working Pressure (MPa)	Flow Rate (l/min)	Spillage (ml)	Force to Connect (N)	Burst pressure (MPa)		
	mm	inch					Male	Female	Male + Female
16	25	1"	27	175	13	110		140	

Material	Steel
Seals	VITON
Working temperatures	- 20 °C to + 200 °C
Surface treatment	MATE 500 (CrIII)
Series Interchange	MARKET

Valve Type	Poppet
Connection	Screw to Connect
Disconnection	Unscrew to Disconnect
Connection Under Pressure	Allowed Residual



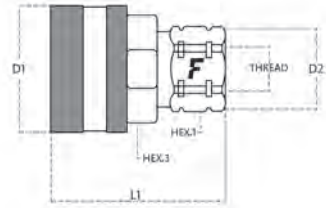

CVLS

Size		Thread details			MALE								
mm	inch	Thread Type	Standard	Thread	Part Number	L (L1 + Thread)		D1		D3		HEX1	
						mm	inch	mm	inch	mm	inch	mm	inch
25	1"	11/ SAE	ISO 8434-3	1-7/16"-12 UN MALE ORFS	CVLS1611/1SAE M	96	3.78	69	2.72			45	1.77
25	1"	F BSPP	ISO 1179-1	BSPP 3/4" FEMALE	CVLS16 34GAS MV	96	3.78	69	2.72			41	1.61

CVLS Accessories and Spares

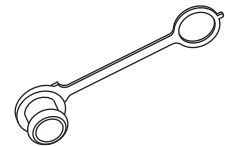

Plastic dust protections

page 249

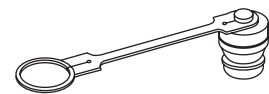

Aluminium dust protections

page 252





CVC

Screw-to-connect couplings for construction equipment application.

Screw-on couplings purposely designed for Caterpillar machines. Connectable under residual pressure. High resistance to pressure and flow impulses. Equipped with a hexagon-shaped sleeve and an external o-ring ensuring high friction and low risk of accidental disconnection due to vibrations.



Applications



Pressure Drop

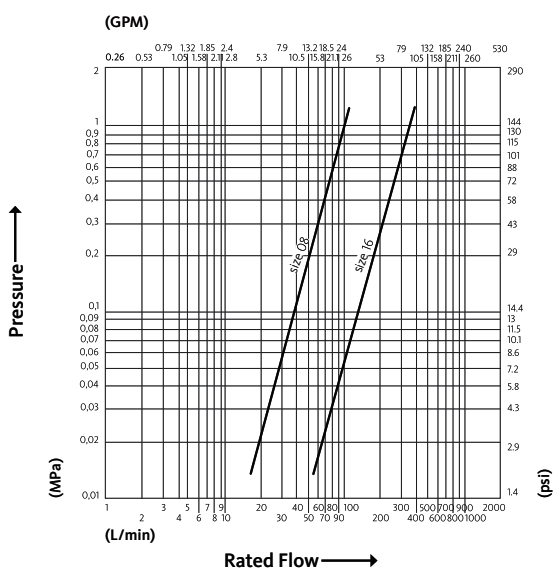

Test performed according to ISO 18869

Technical Specifications

dash	Size mm	inch	Working Pressure (MPa)	Flow Rate (l/min)	Spillage (ml)	Force to Connect (N)	Burst pressure (MPa)		
							Male	Female	Male + Female
08	12.5	1/2"	34	50	2	0	102	102	105
16	25	1"	34	160	10	0	112	112	112

Material	Steel
Seals	NBR
Working temperatures	- 25 °C to + 125 °C
Surface treatment	MATE 500 (CrIII)
Series Interchange	MARKET

Valve Type	Poppet
Connection	Screw to Connect
Disconnection	Unscrew to Disconnect
Connection Under Pressure	Allowed Residual



CVC

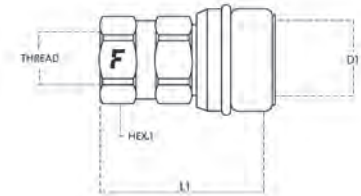

Size		Thread details			FEMALE							
mm	inch	Thread Type	Standard	Thread	Part Number	L (L1 + Thread)		D1		HEX1		
						mm	inch	mm	inch	mm	inch	
12.5	1/2"	02/ METRIC	ISO 8434-1-L	M18x1.5 MALE 12L	CVC082/1815 F	56	2.2	35	1.38	27	1.06	
12.5	1/2"	11/ SAE	ISO 8434-3	13/16"-16 UN MALE ORFS	CVC0811/12S F	58	2.28	35	1.38	27	1.06	
12.5	1/2"	0/ METRIC	ISO 6149-1	M22x1.5 FEMALE ORB	CVC080/2215 F	60	2.36	35	1.38	27	1.06	
12.5	1/2"	0/ SAE	ISO 11926-1	7/8"-14 UNF FEMALE ORB	CVC08 58S F	62	2.44	35	1.38	30	1.18	
12.5	1/2"	F BSPP	ISO 1179-1	BSPP 1/2" FEMALE	CVC08 12 GAS F	50	1.97	35	1.38	30	1.18	
25	1"	0/ SAE	ISO 11926-1	1-3/16"-12 UN FEMALE ORB	CVC16 78S F	97	3.82	54	2.13	42	1.65	
25	1"	F METRIC	ISO 9974-1	M30x1.5 FEMALE	CVC16 3015 F	97	3.82	54	2.13	42	1.65	
25	1"	03/ METRIC	ISO 8434-1-S	M36x2 MALE 25S	CVC163/362 F	98	3.86	54	2.13	38	1.5	

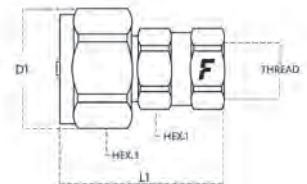

Size		Thread details			MALE								
mm	inch	Thread Type	Standard	Thread	Part Number	L (L1 + Thread)		D1		D3		HEX1	
						mm	inch	mm	inch	mm	inch	mm	inch
12.5	1/2"	02/ METRIC	ISO 8434-1-L	M22x1.5 MALE 15L	CVC082/2215 M	58	2.28	45	1.77			27	1.06
12.5	1/2"	12/ SAE	ISO 8434-3	1"-14 UNS MALE BULKHEAD ORFS	CVC0812/58S M	91	3.58	45	1.77			34	1.34
12.5	1/2"	12/ SAE	ISO 8434-3	13/16"-16 UN MALE BULKHEAD ORFS	CVC0812/12S M	80	3.15	45	1.77			27	1.06
12.5	1/2"	01/ SAE	ISO 11926-3	3/4"-16 UNF MALE	CVC081/12S M	57	2.24	45	1.77			27	1.06
12.5	1/2"	0/ METRIC	ISO 6149-1	M22x1.5 FEMALE ORB	CVC080/2215 M	61	2.4	45	1.77			27	1.06
12.5	1/2"	0/ SAE	ISO 11926-1	7/8"-14 UNF FEMALE ORB	CVC08 58S M	63	2.48	45	1.77			30	1.18
12.5	1/2"	F BSPP	ISO 1179-1	BSPP 1/2" FEMALE	CVC08 12 GAS M	48	1.89	45	1.77			30	1.18
25	1"	0/ SAE	ISO 11926-1	1-5/16"-12 UN FEMALE ORB	CVC16 1SAE M	91	3.58	72	2.83			42	1.65
25	1"	34/ SAE	ISO 6162-2	SAE FLANGE 3/4	CVC1634/12 M	89	3.5	72	2.83			42	1.65
25	1"	03/ METRIC	ISO 8434-1-S	M42x2 MALE 30S	CVC163/422 M	88	3.46	72	2.83			46	1.81
25	1"	03/ METRIC	ISO 8434-1-S	M36x2 MALE 25S	CVC163/362 M	91	3.58	72	2.83			38	1.5
25	1"	0/ SAE	ISO 11926-1	1-3/16"-12 UN FEMALE ORB	CVC16 78S M	90	3.54	72	2.83			42	1.65
25	1"	F METRIC	ISO 9974-1	M30x1.5 FEMALE	CVC16 3015 M	90	3.54	72	2.83			42	1.65

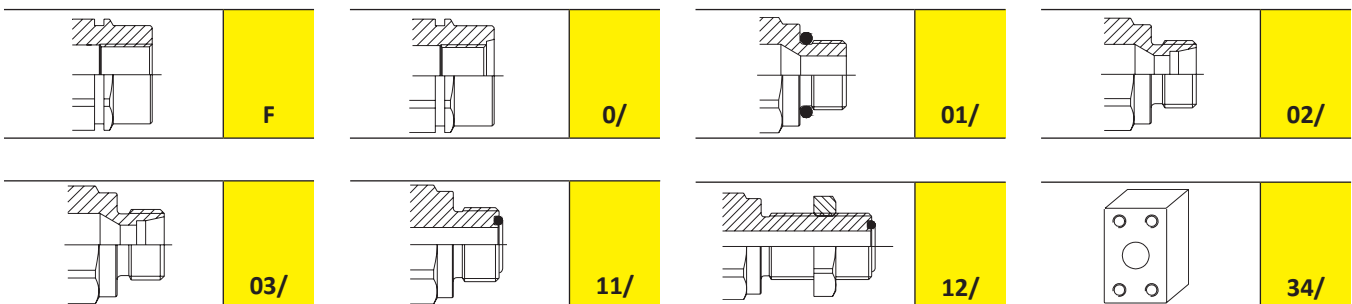

CVC Accessories and Spares



Aluminium dust protections

page 252



Seals Kits

page 262

CVE



Screw to connect couplings for road machines applications.

Couplings designed for the transport industry. Composed by a screw-on sleeve (brass) and wings nuts with hexagon shape.

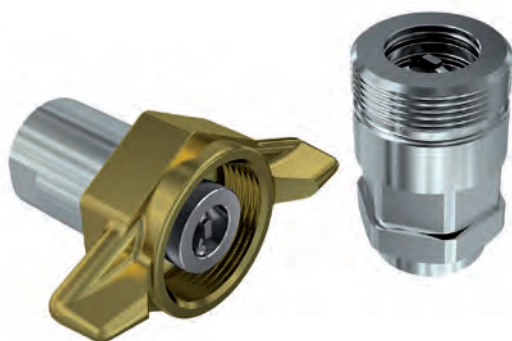

Applications



Pressure Drop

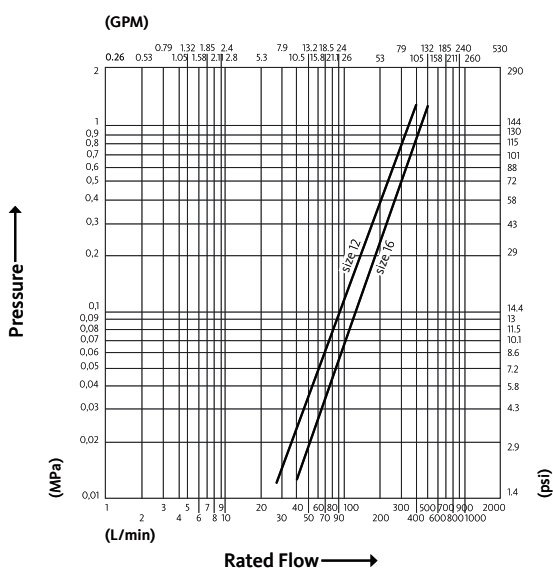

Test performed according to ISO 18869

Technical Specifications

dash	Size mm	inch	Working Pressure (MPa)	Flow Rate (l/min)	Spillage (ml)	Force to Connect (N)	Burst pressure (MPa)		
							Male	Female	Male + Female
12	20	3/4"	36	120	10	0	110	130	130
16	25	1"	30	160	15	0	120	90	130

Material	Steel
Seals	NBR
Working temperatures	- 25 °C to + 125 °C
Surface treatment	MATE 500 (CrIII)
Series Interchange	MARKET

Valve Type	Poppet
Connection	Screw to Connect
Disconnection	Unscrew to Disconnect
Connection Under Pressure	Allowed Residual



CVE

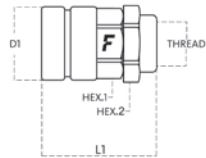

Size		Thread details			FEMALE						
mm	inch	Thread Type	Standard	Thread	Part Number	L (L1 + Thread)		D1		HEX1	
						mm	inch	mm	inch	mm	inch
20	3/4"	F BSPP	ISO 1179-1	BSPP 3/4" FEMALE	CVE 34 GAS F	78	3.07	51	2.01	46	1.81
25	1"	F BSPP	ISO 1179-1	BSPP 1" FEMALE	CVE 1 GAS F	85	3.35	54	2.13	46	1.81

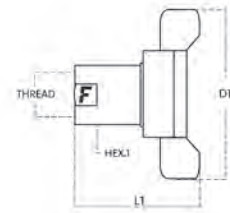

Size		Thread details			MALE								
mm	inch	Thread Type	Standard	Thread	Part Number	L (L1 + Thread)		D1		D3		HEX1	
						mm	inch	mm	inch	mm	inch	mm	inch
20	3/4"	F BSPP	ISO 1179-1	BSPP 3/4" FEMALE	CVE 34 GAS M	84	3.31	100	3.94			34	1.34
25	1"	F BSPP	ISO 1179-1	BSPP 1" FEMALE	CVE 1 GAS M	94.4	3.72	127	5			41	1.61

CVE Accessories and Spares



Aluminium dust protections

page 252

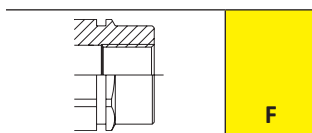



VV

Screw to connect standard couplings, double function sleeve.

VV series couplings are very robust and reliable and allow to connect under residual pressure. Thanks to a double function sleeve it's also possible to connect a female part with either VV or NV male halves. Faster proprietary profile.



Applications



Pressure Drop

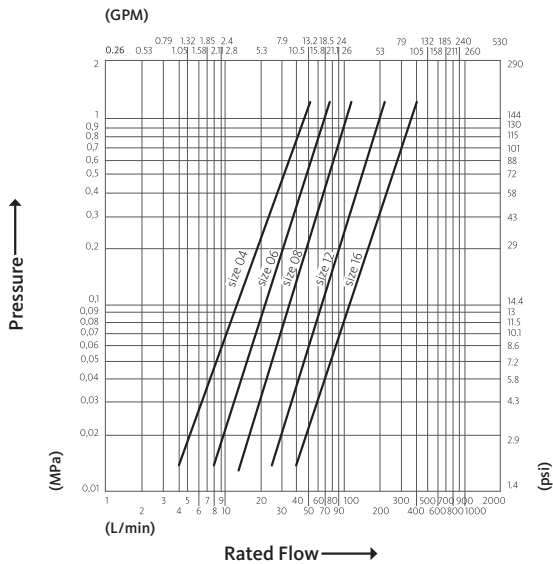

Test performed according to ISO 18869

Technical Specifications

dash	Size mm	inch	Working Pressure (MPa)	Flow Rate (l/min)	Spillage (ml)	Force to Connect (N)	Burst pressure (MPa)		
							Male	Female	Male + Female
04	6.3	1/4"	35	18	0.8	140	170	150	
06	10	3/8"	30	30	1.3	120	120	150	
08	12.5	1/2"	25	65	1.8	100	130	160	
12	20	3/4"	25	100	8	100	100	120	
16	25	1"	22	140	13	90	100	100	

Material	Steel
Seals	NBR
Working temperatures	- 25 °C to + 125 °C
Surface treatment	MATE 500 (CrIII)
Series Interchange	FASTER

Valve Type	Poppet
Connection	Screw to Connect
Disconnection	Unscrew to Disconnect
Connection Under Pressure	Allowed Residual



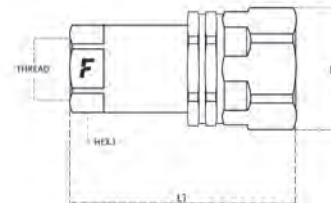

Size		Thread details			FEMALE						
mm	inch	Thread Type	Standard	Thread	Part Number	L (L1 + Thread)		D1		HEX1	
						mm	inch	mm	inch	mm	inch
6.3	1/4"	F NPTF	ANSI B1.20.3	NPTF 1/4" FEMALE	VV 14 NPT F	60	2.36	30	1.18	19	0.75
6.3	1/4"	F BSPP	ISO 1179-1	BSPP 1/4" FEMALE	VV 14 GAS F	60	2.36	30	1.18	19	0.75
10	3/8"	F BSPP	ISO 1179-1	BSPP 3/8" FEMALE	VV 38 GAS F	72	2.83	38	1.5	24	0.94
10	3/8"	F NPTF	ANSI B1.20.3	NPTF 3/8" FEMALE	VV 38 NPT F	72	2.83	38	1.5	24	0.94
12.5	1/2"	F NPTF	ANSI B1.20.3	NPTF 1/2" FEMALE	VV 12 NPT F	79	3.11	42	1.65	27	1.06
12.5	1/2"	F BSPP	ISO 1179-1	BSPP 1/2" FEMALE	VV 12 GAS F	79	3.11	42	1.65	27	1.06
20	3/4"	F NPTF	ANSI B1.20.3	NPTF 3/4" FEMALE	VV 34 NPT F	106	4.17	55	2.17	34	1.34
20	3/4"	F BSPP	ISO 1179-1	BSPP 3/4" FEMALE	VV 34 GAS F	106	4.17	55	2.17	34	1.34
25	1"	F NPTF	ANSI B1.20.3	NPTF 1" FEMALE	VV 1 NPT F	124	4.88	61.5	2.42	41	1.61
25	1"	F BSPP	ISO 1179-1	BSPP 1" FEMALE	VV 1 GAS F	124	4.88	61.5	2.42	41	1.61

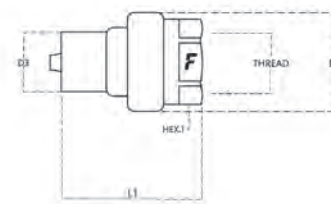

Size		Thread details			MALE								
mm	inch	Thread Type	Standard	Thread	Part Number	L (L1 + Thread)		D1		D3		HEX1	
						mm	inch	mm	inch	mm	inch	mm	inch
6.3	1/4"	F NPTF	ANSI B1.20.3	NPTF 1/4" FEMALE	VV 14 NPT M	33	1.3	25.4	1	14.1	0.56	19	0.75
6.3	1/4"	F BSPP	ISO 1179-1	BSPP 1/4" FEMALE	VV 14 GAS M	34.7	1.37	25.4	1	14.1	0.56	19	0.75
10	3/8"	F BSPP	ISO 1179-1	BSPP 3/8" FEMALE	VV 38 GAS M	40.5	1.59	30.4	1.2	18.9	0.74	24	0.94
10	3/8"	F NPTF	ANSI B1.20.3	NPTF 3/8" FEMALE	VV 38 NPT M	40.5	1.59	30.4	1.2	18.9	0.74	24	0.94
12.5	1/2"	F NPTF	ANSI B1.20.3	NPTF 1/2" FEMALE	VV 12 NPT M	49	1.93	34	1.34	20.5	0.81	27	1.06
12.5	1/2"	F BSPP	ISO 1179-1	BSPP 1/2" FEMALE	VV 12 GAS M	49	1.93	34	1.34	20.5	0.81	27	1.06
20	3/4"	F NPTF	ANSI B1.20.3	NPTF 3/4" FEMALE	VV 34 NPT M	62	2.44	43.5	1.71	27.9	1.1	34	1.34
20	3/4"	F BSPP	ISO 1179-1	BSPP 3/4" FEMALE	VV 34 GAS M	62	2.44	43.5	1.71	27.9	1.1	34	1.34
25	1"	F NPTF	ANSI B1.20.3	NPTF 1" FEMALE	VV 1 NPT M	73	2.87	52	2.05	31.8	1.25	41	1.61
25	1"	F BSPP	ISO 1179-1	BSPP 1" FEMALE	VV 1 GAS M	73	2.87	52	2.05	31.8	1.25	41	1.61

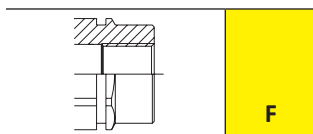

VV Accessories and Spares

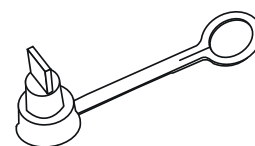
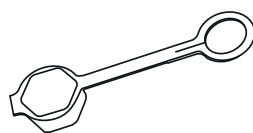

PVC dust protections

page 243

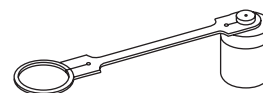
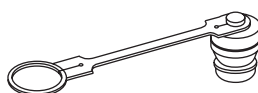

Aluminium dust protections

page 252

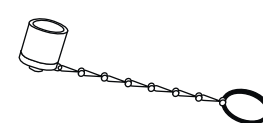

Stainless steel dust protections

page 258



VVS

Screw to connect couplings for high pressure applications, Faster interchange.

Screw-on couplings commonly used for applications characterized by very high working pressures and peaks. Heavy duty internal components guarantee the maximum safety and reliability. Faster proprietary profile. Interchangeable with Faster VV series.



Applications



Pressure Drop

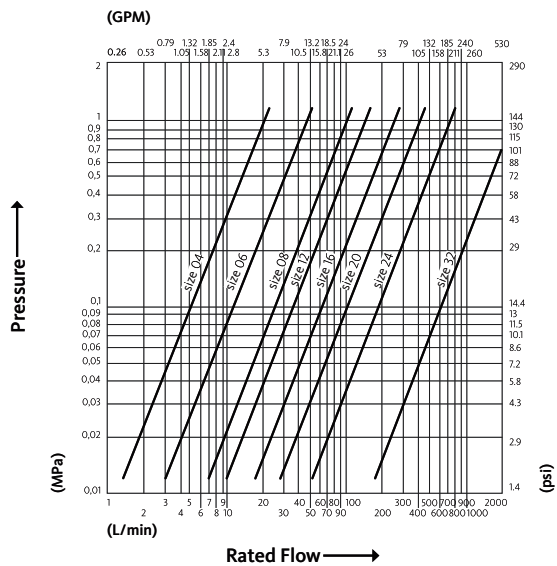

Test performed according to ISO 18869

Technical Specifications

dash	Size mm	inch	Working Pressure (MPa)	Flow Rate (l/min)	Spillage (ml)	Force to Connect (N)	Burst pressure (MPa)		
							Male	Female	Male + Female
04	6.3	1/4"	80	8	0.4	0	240	240	250
06	10	3/8"	80	18	0.8	0	340	350	240
08	12.5	1/2"	70	40	1.3	0	210	210	210
12	20	3/4"	70	55	1.8	0	240	210	230
16	25	1"	63	100	8	0	190	240	190
20	31.5	1-1/4"	60	140	15	0	180	180	200
24	37.5	1-1/2"	40	300	38	0	120	150	150
32	50	2"	35	1000	46	0	130	130	105

Material	Steel
Seals	NBR
Working temperatures	- 25 °C to + 125 °C
Surface treatment	MATE 500 (CrIII)
Series Interchange	FASTER

Valve Type	Poppet
Connection	Screw to Connect
Disconnection	Unscrew to Disconnect
Connection Under Pressure	Not Allowed



VVS

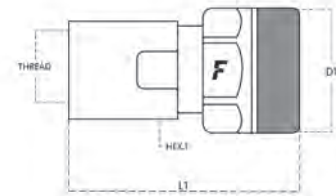

Size		Thread details			FEMALE						
mm	inch	Thread Type	Standard	Thread	Part Number	L (L1 + Thread)		D1		HEX1	
						mm	inch	mm	inch	mm	inch
6.3	1/4"	F NPTF	ANSI B1.20.3	NPTF 1/4" FEMALE	VVS 14 NPT F	68	2.68	30	1.18	22	0.87
6.3	1/4"	F BSPP	ISO 1179-1	BSPP 1/4" FEMALE	VVS 14 GAS F	68	2.68	30	1.18	22	0.87
10	3/8"	F NPTF	ANSI B1.20.3	NPTF 3/8" FEMALE	VVS 38 NPT F	76	2.99	40	1.57	30	1.18
10	3/8"	F BSPP	ISO 1179-1	BSPP 3/8" FEMALE	VVS 38 GAS F	76	2.99	40	1.57	30	1.18
12.5	1/2"	F NPTF	ANSI B1.20.3	NPTF 1/2" FEMALE	VVS 12 NPT F	87	3.43	45	1.77	34	1.34
12.5	1/2"	F BSPP	ISO 1179-1	BSPP 1/2" FEMALE	VVS 12 GAS F	87	3.43	45	1.77	34	1.34
20	3/4"	F NPTF	ANSI B1.20.3	NPTF 3/4" FEMALE	VVS 34 NPT F	106	4.17	55	2.17	41	1.61
20	3/4"	F BSPP	ISO 1179-1	BSPP 3/4" FEMALE	VVS 34 GAS F	106	4.17	55	2.17	41	1.61
25	1"	F NPTF	ANSI B1.20.3	NPTF 1" FEMALE	VVS 1 NPT F	124	4.88	60	2.36	50	1.97
25	1"	F BSPP	ISO 1179-1	BSPP 1" FEMALE	VVS 1 GAS F	124	4.88	60	2.36	50	1.97
31.5	1-1/4"	F NPTF	ANSI B1.20.3	NPTF 1-1/4" FEMALE	VVS114 NPT F	152	5.98	80	3.15	65	2.56
31.5	1-1/4"	F BSPP	ISO 1179-1	BSPP 1-1/4" FEMALE	VVS114 GAS F	152	5.98	80	3.15	65	2.56
37.5	1-1/2"	F NPTF	ANSI B1.20.3	NPTF 1-1/2" FEMALE	VVS112 NPT F	172	6.77	98	3.86	75	2.95
37.5	1-1/2"	F BSPP	ISO 1179-1	BSPP 1-1/2" FEMALE	VVS112 GAS F	172	6.77	98	3.86	75	2.95
50	2"	F NPTF	ANSI B1.20.3	NPTF 2" FEMALE	VVS 2 NPT F	207	8.15	129	5.08	100	3.94
50	2"	F BSPP	ISO 1179-1	BSPP 2" FEMALE	VVS 2 GAS F	206	8.11	129	5.08	100	3.94

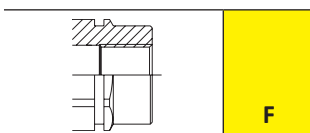

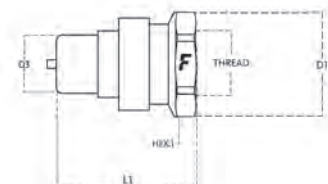

VVS

Size		Thread details			MALE									
mm	inch	Thread Type	Standard	Thread	Part Number	L (L1 + Thread)		D1		D3		HEX1		
						mm	inch	mm	inch	mm	inch	mm	inch	
6.3	1/4"	F NPTF	ANSI B1.20.3	NPTF 1/4" FEMALE	VVS 14 NPT M	48	1.89	28	1.1	14.1	0.56	32	1.26	
6.3	1/4"	F BSPP	ISO 1179-1	BSPP 1/4" FEMALE	VVS 14 GAS M	43	1.69	28	1.1	14.1	0.56	25	0.98	
10	3/8"	F NPTF	ANSI B1.20.3	NPTF 3/8" FEMALE	VVS 38 NPT M	48	1.89	35	1.38	18.9	0.74	30	1.18	
10	3/8"	F BSPP	ISO 1179-1	BSPP 3/8" FEMALE	VVS 38 GAS M	48	1.89	35	1.38	18.9	0.74	30	1.18	
12.5	1/2"	F NPTF	ANSI B1.20.3	NPTF 1/2" FEMALE	VVS 12 NPT M	53	2.09	38	1.5	20.5	0.81	34	1.34	
12.5	1/2"	F BSPP	ISO 1179-1	BSPP 1/2" FEMALE	VVS 12 GAS M	53	2.09	38	1.5	20.5	0.81	34	1.34	
20	3/4"	F NPTF	ANSI B1.20.3	NPTF 3/4" FEMALE	VVS 34 NPT M	63	2.48	50	1.97	27.9	1.1	45	1.77	
20	3/4"	F BSPP	ISO 1179-1	BSPP 3/4" FEMALE	VVS 34 GAS M	63	2.48	50	1.97	27.9	1.1	46	1.81	
25	1"	F NPTF	ANSI B1.20.3	NPTF 1" FEMALE	VVS 1 NPT M	72	2.83	55	2.17	31.3	1.23	50	1.97	
25	1"	F BSPP	ISO 1179-1	BSPP 1" FEMALE	VVS 1 GAS M	72	2.83	55	2.17	31.3	1.23	50	1.97	
31.5	1-1/4"	F NPTF	ANSI B1.20.3	NPTF 1-1/4" FEMALE	VVS114 NPT M	86	3.39	70	2.76	43.9	1.73	65	2.56	
31.5	1-1/4"	F BSPP	ISO 1179-1	BSPP 1-1/4" FEMALE	VVS114 GAS M	86	3.39	70	2.76	43.9	1.73	65	2.56	
37.5	1-1/2"	F NPTF	ANSI B1.20.3	NPTF 1-1/2" FEMALE	VVS112 NPT M	95	3.74	84	3.31	53.4	2.1	80	3.15	
37.5	1-1/2"	F BSPP	ISO 1179-1	BSPP 1-1/2" FEMALE	VVS112 GAS M	95	3.74	84	3.31	53.4	2.1	80	3.15	
50	2"	F NPTF	ANSI B1.20.3	NPTF 2" FEMALE	VVS 2 NPT M	118	4.65	115	4.53	81.9	3.22	110	4.33	
50	2"	F BSPP	ISO 1179-1	BSPP 2" FEMALE	VVS 2 GAS M	118	4.65	115	4.53	81.9	3.22	110	4.33	

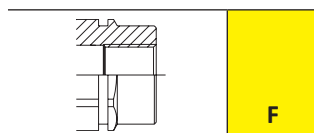
Screw to
Connect

VVS Accessories and Spares



Aluminium dust protections

page 252

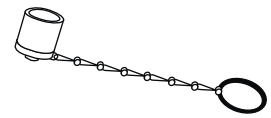

Stainless steel dust protections

page 258

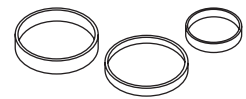

Seals Kits

page 262



VVS stainless steel

Screw to connect couplings for high pressure applications, Faster interchange, stainless steel.

Screw-on stainless steel (AISI 316) couplings commonly used for applications characterized by very high working pressures and peaks. High resistance to corrosion. Heavy duty internal components guarantee the maximum safety and reliability. Faster proprietary profile.



Applications



Pressure Drop

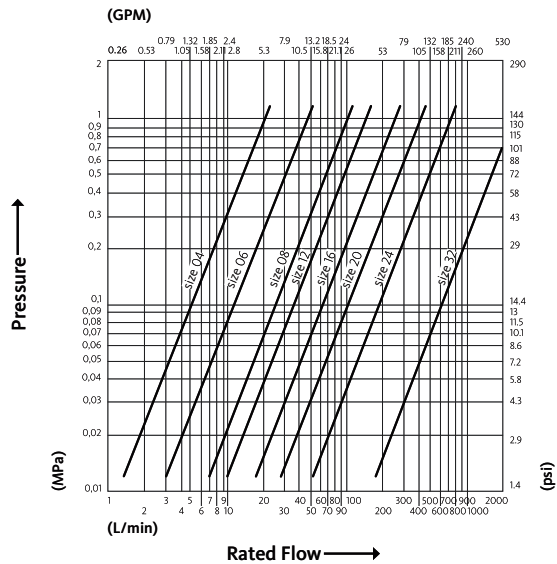

Test performed according to ISO 18869

Technical Specifications

dash	Size mm	inch	Working Pressure (MPa)	Flow Rate (l/min)	Spillage (ml)	Force to Connect (N)	Burst pressure (MPa)		
							Male	Female	Male + Female
04	6.3	1/4"	60	8	0.4	0	180	280	280
06	10	3/8"	65	18	0.8	0	195	200	250
08	12.5	1/2"	60	30	1.3	0	180	195	245
12	20	3/4"	50	45	1.8	0	150	160	190
16	25	1"	46	90	8	0	150	140	160
20	31.5	1-1/4"	38	140	15	0	115	120	150
24	37.5	1-1/2"	36	300	38	0	110	140	155
32	50	2"	21	1000	46	0	65	75	85

Material	Stainless Steel
Seals	VITON
Working temperatures	- 20 °C to + 200 °C
Surface treatment	
Series Interchange	FASTER

Valve Type	Poppet
Connection	Screw to Connect
Disconnection	Unscrew to Disconnect
Connection Under Pressure	Allowed Residual



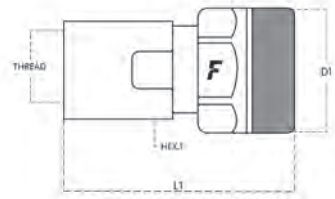

VVS stainless steel

Size		Thread details			FEMALE						
mm	inch	Thread Type	Standard	Thread	Part Number	L (L1 + Thread)		D1		HEX1	
						mm	inch	mm	inch	mm	inch
6.3	1/4"	F NPTF	ANSI B1.20.3	NPTF 1/4" FEMALE	VVS 14 NPT F 2V	68	2.68	30	1.18	22	0.87
6.3	1/4"	F BSPP	ISO 1179-1	BSPP 1/4" FEMALE	VVS 14 GAS F 2V	68	2.68	30	1.18	22	0.87
10	3/8"	F NPTF	ANSI B1.20.3	NPTF 3/8" FEMALE	VVS 38 NPT F 2V	76	2.99	40	1.57	30	1.18
10	3/8"	F BSPP	ISO 1179-1	BSPP 3/8" FEMALE	VVS 38 GAS F 2V	75.4	2.97	40	1.57	30	1.18
12.5	1/2"	F NPTF	ANSI B1.20.3	NPTF 1/2" FEMALE	VVS 12 NPT F 2V	87	3.43	45	1.77	34	1.34
12.5	1/2"	F BSPP	ISO 1179-1	BSPP 1/2" FEMALE	VVS 12 GAS F 2V	87	3.43	45	1.77	34	1.34
20	3/4"	F NPTF	ANSI B1.20.3	NPTF 3/4" FEMALE	VVS 34 NPT F 2V	106	4.17	55	2.17	41	1.61
20	3/4"	F BSPP	ISO 1179-1	BSPP 3/4" FEMALE	VVS 34 GAS F 2V	106	4.17	55	2.17	41	1.61
25	1"	F NPTF	ANSI B1.20.3	NPTF 1" FEMALE	VVS 1 NPT F 2V	124	4.88	60	2.36	50	1.97
25	1"	F BSPP	ISO 1179-1	BSPP 1" FEMALE	VVS 1 GAS F 2V	124	4.88	60	2.36	50	1.97
31.5	1-1/4"	F NPTF	ANSI B1.20.3	NPTF 1-1/4" FEMALE	VVS114 NPT F 2V	153	6.02	80	3.15	65	2.56
31.5	1-1/4"	F BSPP	ISO 1179-1	BSPP 1-1/4" FEMALE	VVS114 GAS F 2V	153	6.02	80	3.15	65	2.56
37.5	1-1/2"	F NPTF	ANSI B1.20.3	NPTF 1-1/2" FEMALE	VVS112 NPT F 2V	172	6.77	98	3.86	75	2.95
37.5	1-1/2"	F BSPP	ISO 1179-1	BSPP 1-1/2" FEMALE	VVS112 GAS F 2V	172	6.77	98	3.86	75	2.95
50	2"	F NPTF	ANSI B1.20.3	NPTF 2" FEMALE	VVS 2 NPT F 2V	207	8.15	129	5.08	100	3.94
50	2"	F BSPP	ISO 1179-1	BSPP 2" FEMALE	VVS 2 GAS F 2V	207	8.15	129	5.08	100	3.94

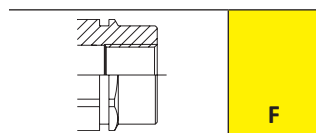

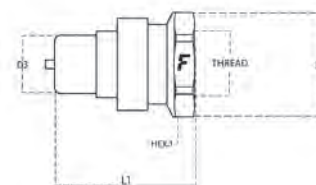

VVS stainless steel

Size		Thread details			MALE									
mm	inch	Thread Type	Standard	Thread	Part Number	L (L1 + Thread)		D1		D3		HEX1		
						mm	inch	mm	inch	mm	inch	mm	inch	
6.3	1/4"	F NPTF	ANSI B1.20.3	NPTF 1/4" FEMALE	VVS 14 NPT M 2V	43	1.69	28	1.1	14.1	0.56	25	0.98	
6.3	1/4"	F BSPP	ISO 1179-1	BSPP 1/4" FEMALE	VVS 14 GAS M 2V	43	1.69	28	1.1	14.1	0.56	25	0.98	
10	3/8"	F NPTF	ANSI B1.20.3	NPTF 3/8" FEMALE	VVS 38 NPT M 2V	48	1.89	35	1.38	18.9	0.74	32	1.26	
10	3/8"	F BSPP	ISO 1179-1	BSPP 3/8" FEMALE	VVS 38 GAS M 2V	48	1.89	35	1.38	18.9	0.74	32	1.26	
12.5	1/2"	F NPTF	ANSI B1.20.3	NPTF 1/2" FEMALE	VVS 12 NPT M 2V	53	2.09	38	1.5	20.5	0.81	34	1.34	
12.5	1/2"	F BSPP	ISO 1179-1	BSPP 1/2" FEMALE	VVS 12 GAS M 2V	53	2.09	38	1.5	20.5	0.81	34	1.34	
20	3/4"	F NPTF	ANSI B1.20.3	NPTF 3/4" FEMALE	VVS 34 NPT M 2V	63	2.48	50	1.97	27.9	1.1	46	1.81	
20	3/4"	F BSPP	ISO 1179-1	BSPP 3/4" FEMALE	VVS 34 GAS M 2V	63	2.48	50	1.97	27.9	1.1	65	2.56	
25	1"	F NPTF	ANSI B1.20.3	NPTF 1" FEMALE	VVS 1 NPT M 2V	72	2.83	55	2.17	31.3	1.23	50	1.97	
25	1"	F BSPP	ISO 1179-1	BSPP 1" FEMALE	VVS 1 GAS M 2V	72	2.83	55	2.17	31.3	1.23	50	1.97	
31.5	1-1/4"	F NPTF	ANSI B1.20.3	NPTF 1-1/4" FEMALE	VVS114 NPT M 2V	86	3.39	70	2.76	43.9	1.73	65	2.56	
31.5	1-1/4"	F BSPP	ISO 1179-1	BSPP 1-1/4" FEMALE	VVS114 GAS M 2V	86	3.39	70	2.76	43.9	1.73	65	2.56	
37.5	1-1/2"	F NPTF	ANSI B1.20.3	NPTF 1-1/2" FEMALE	VVS112 NPT M 2V	95	3.74	84	3.31	53.4	2.1	80	3.15	
37.5	1-1/2"	F BSPP	ISO 1179-1	BSPP 1-1/2" FEMALE	VVS112 GAS M 2V	95	3.74	84	3.31	53.4	2.1	80	3.15	
50	2"	F NPTF	ANSI B1.20.3	NPTF 2" FEMALE	VVS 2 NPT M 2V	118	4.65	115	4.53	81.9	3.22	110	4.33	
50	2"	F BSPP	ISO 1179-1	BSPP 2" FEMALE	VVS 2 GAS M 2V	118	4.65	115	4.53	81.9	3.22	110	4.33	

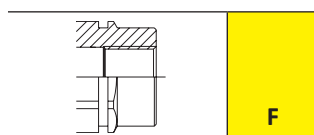

VVS stainless steel Accessories and Spares

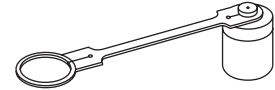

Aluminium dust protections

page 252

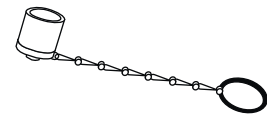
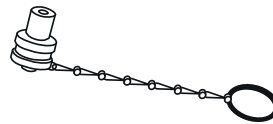

Stainless steel dust protections

page 258

VVM



Screw to connect standard couplings, metal-to-metal sealing.

VVM couplings are characterized by screw to connect sleeve and metal-to-metal sealing system when disconnected. Poppet valve shut-off.



Applications



Pressure Drop

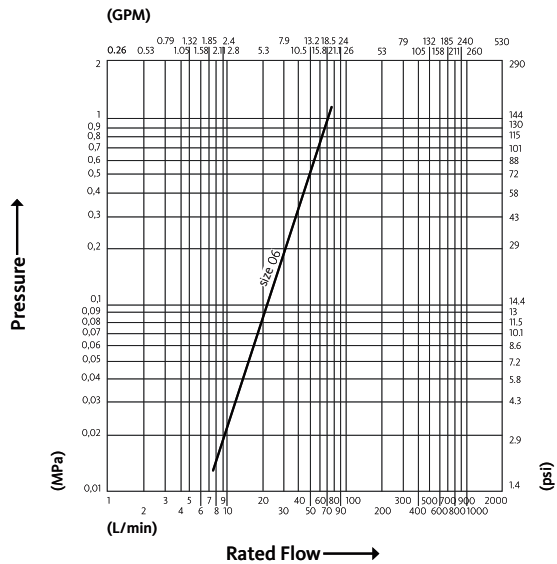

Test performed according to ISO 18869

Technical Specifications

dash	Size		Working Pressure (MPa)	Flow Rate (l/min)	Spillage (ml)	Force to Connect (N)	Burst pressure (MPa)		
	mm	inch					Male	Female	Male + Female
06	10	3/8"	43	45	2	130	140	210	

Material	Steel
Seals	NBR
Working temperatures	- 25 °C to + 125 °C
Surface treatment	MATE 500 (CrIII)
Series Interchange	FASTER

Valve Type	Poppet
Connection	Screw to Connect
Disconnection	Unscrew to Disconnect
Connection Under Pressure	Allowed Residual



VVM

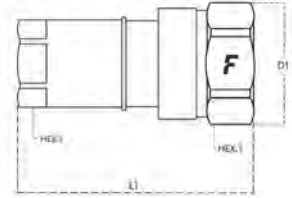

Size		Thread details			FEMALE						
mm	inch	Thread Type	Standard	Thread	Part Number	L (L1 + Thread)		D1		HEX1	
						mm	inch	mm	inch	mm	inch
10	3/8"	F BSPP	ISO 1179-1	BSPP 3/8" FEMALE	VVM 38 GAS F	74	2.91	38	1.5	24	0.94

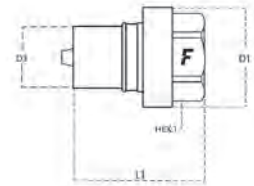

Size		Thread details			MALE								
mm	inch	Thread Type	Standard	Thread	Part Number	L (L1 + Thread)		D1		D3		HEX1	
						mm	inch	mm	inch	mm	inch	mm	inch
10	3/8"	F BSPP	ISO 1179-1	BSPP 3/8" FEMALE	VVM 38 GAS M	40.5	1.59	30.4	1.2	19	0.75	24	0.94

VVM Accessories and Spares

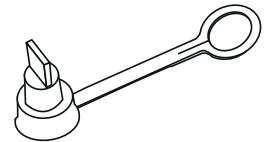
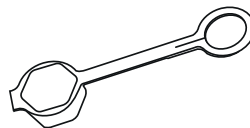

PVC dust protections

page 243



Aluminium dust protections

page 252

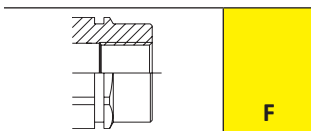



FB

Screw to connect couplings for road machines applications.

Screw-on flat face brass couplings suitable to vehicles and road machines applications. A wing-shaped sleeve helps to connect and disconnect by hand. Interchangeable for US market.



Applications



Pressure Drop

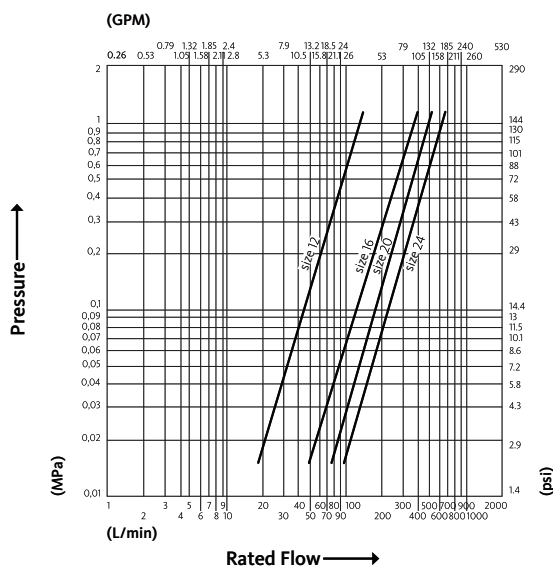

Test performed according to ISO 18869

Technical Specifications

dash	Size mm	inch	Working Pressure (MPa)	Flow Rate (l/min)	Spillage (ml)	Force to Connect (N)	Burst pressure (MPa)		
							Male	Female	Male + Female
12	20	3/4"	25	62	0.1	0	100	75	82
16	25	1"	23	160	0.2	0	130	70	80
20	31.5	1-1/4"	21	220	0.5	0	78	64	68
24	37.5	1-1/2"	20	300	0.7	0	60	60	62

Material	Brass
Seals	NBR
Working temperatures	- 25 °C to + 125 °C
Surface treatment	
Series Interchange	MARKET

Valve Type	Flat
Connection	Screw to Connect
Disconnection	Unscrew to Disconnect
Connection Under Pressure	Allowed Residual



FB

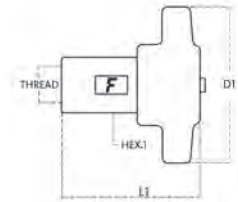

Size		Thread details			FEMALE						
mm	inch	Thread Type	Standard	Thread	Part Number	L (L1 + Thread)		D1		HEX1	
						mm	inch	mm	inch	mm	inch
20	3/4"	F NPTF	ANSI B1.20.3	NPTF 3/4" FEMALE	FB 12/34 NPT F5	81	3.19	90	3.54	30	1.18
20	3/4"	F NPTF	ANSI B1.20.3	NPTF 1/2" FEMALE	FB 12/12 NPT F5	81	3.19	90	3.54	30	1.18
25	1"	F NPTF	ANSI B1.20.3	NPTF 1" FEMALE	FB 16/1 NPT F 5	90.8	3.57	75	2.95	36	1.42
31.5	1-1/4"	F NPTF	ANSI B1.20.3	NPTF 1-1/4" FEMALE	FB 20/114NPT F5	95	3.74	127	5	45	1.77
37.5	1-1/2"	F NPTF	ANSI B1.20.3	NPTF 1-1/2" FEMALE	FB 24/112NPT F5	110.2	4.34	150	5.91	50	1.97

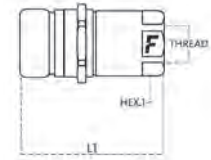

Size		Thread details			MALE								
mm	inch	Thread Type	Standard	Thread	Part Number	L (L1 + Thread)		D1		D3		HEX1	
						mm	inch	mm	inch	mm	inch	mm	inch
20	3/4"	F NPTF	ANSI B1.20.3	NPTF 3/4" FEMALE	FB 12/34 NPT M5	82	3.23	45	1.77			34	1.34
20	3/4"	F NPTF	ANSI B1.20.3	NPTF 1/2" FEMALE	FB 12/12 NPT M5	81.3	3.2	45	1.77			34	1.34
25	1"	F NPTF	ANSI B1.20.3	NPTF 1" FEMALE	FB 16/1 NPT M 5	90.8	3.57	75	2.95			36	1.42
31.5	1-1/4"	F NPTF	ANSI B1.20.3	NPTF 1-1/4" FEMALE	FB 20/114NPT M5	95	3.74	127	5			45	1.77
37.5	1-1/2"	F NPTF	ANSI B1.20.3	NPTF 1-1/2" FEMALE	FB 24/112NPT M5	110	4.33	72	2.83			55	2.17

FB Accessories and Spares

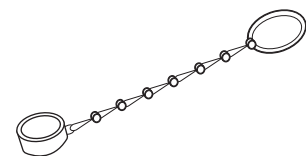
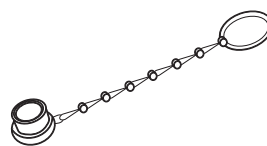

Aluminium dust protections

page 252

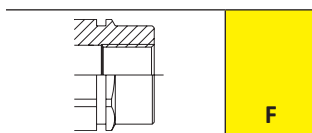



OGV

Screw to connect couplings for oil & gas application, market interchange.

Standard screw to connect coupling suitable for Oil & Gas applications. Robust sleeve design, poppet valve and ACME connection thread.



Applications



Pressure Drop

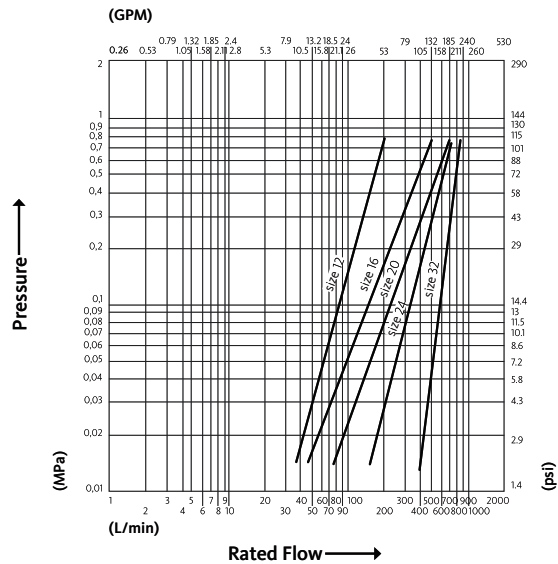

Technical Specifications

dash	Size mm	inch	Working Pressure (MPa)	Flow Rate (l/min)	Spillage (ml)	Force to Connect (N)	Burst pressure (MPa)		
							Male	Female	Male + Female
12	20	3/4"	35	120	8	168	160	165	
16	25	1"	35	230	18	165	165	172	
20	31.5	1-1/4"	35	320	21	180	200	178	
24	37.5	1-1/2"	35	330	41	160	176	170	
32	50	2"	35	570	85	125	130	125	

Material	Steel
Seals	NBR; PUR
Working temperatures	- 25 °C to + 100 °C
Surface treatment	MATE 500 (CrIII)
Series Interchange	MARKET

Valve Type	Poppet
Connection	Screw to Connect
Disconnection	Unscrew to Disconnect
Connection Under Pressure	Allowed Residual



OGV

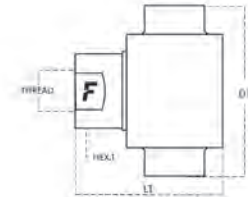

Size		Thread details			FEMALE							
mm	inch	Thread Type	Standard	Thread	Part Number	L (L1 + Thread)		D1		HEX1		
						mm	inch	mm	inch	mm	inch	
20	3/4"	F NPSF	ANSI B1.20.3	NPSF 3/4 FEMALE	OGV12 34NPS F	72.2	2.84	55	2.17	32	1.26	
25	1"	F NPSF	ANSI B1.20.3	NPSF 1 FEMALE	OGV16 1NPS F	87.6	3.45	105.5	4.15	41	1.61	
31.5	1-1/4"	F NPTF	ANSI B1.20.3	NPTF 1-1/4" FEMALE	OGV20 114NPT F	111.9	4.41	118.2	4.65	50	1.97	
37.5	1-1/2"	F NPTF	ANSI B1.20.3	NPTF 1-1/2" FEMALE	OGV24 112NPT F	127.1	5	147	5.79	55	2.17	
50	2"	F NPTF	ANSI B1.20.3	NPTF 2" FEMALE	OGV32 2NPT F	154.2	6.07	170	6.69	75	2.95	

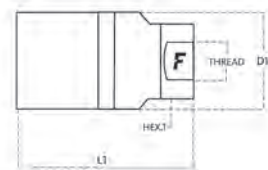

Size		Thread details			MALE								
mm	inch	Thread Type	Standard	Thread	Part Number	L (L1 + Thread)		D1		D3		HEX1	
						mm	inch	mm	inch	mm	inch	mm	inch
20	3/4"	F NPSF	ANSI B1.20.3	NPSF 3/4 FEMALE	OGV12 34NPS M	83.1	3.27	44.25	1.74			32	1.26
25	1"	F NPSF	ANSI B1.20.3	NPSF 1 FEMALE	OGV16 1NPS M	106	4.17	57.12	2.25			41	1.61
31.5	1-1/4"	F NPTF	ANSI B1.20.3	NPTF 1-1/4" FEMALE	OGV20 114NPT M	136.5	5.37	66.65	2.62			50	1.97
37.5	1-1/2"	F NPTF	ANSI B1.20.3	NPTF 1-1/2" FEMALE	OGV24 112NPT M	151.7	5.97	82.52	3.25			55	2.17
50	2"	F NPTF	ANSI B1.20.3	NPTF 2" FEMALE	OGV32 2NPT M	179.1	7.05	101.57	4			75	2.95

OGV Accessories and Spares



Aluminium dust protections

page 252

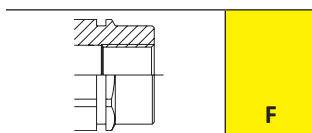



OGVST

Screw to connect couplings for Oil & Gas application, market interchange. Equipped with a marker that confirms the complete connection and a longer locking sleeve for an improved engagement.

Screw-to-connect coupling suitable for Oil & Gas applications. Robust sleeve design, poppet valve and ACME connection thread. Equipped with a marker that confirms the complete connection and a longer locking sleeve for an improved engagement.



Applications



Pressure Drop

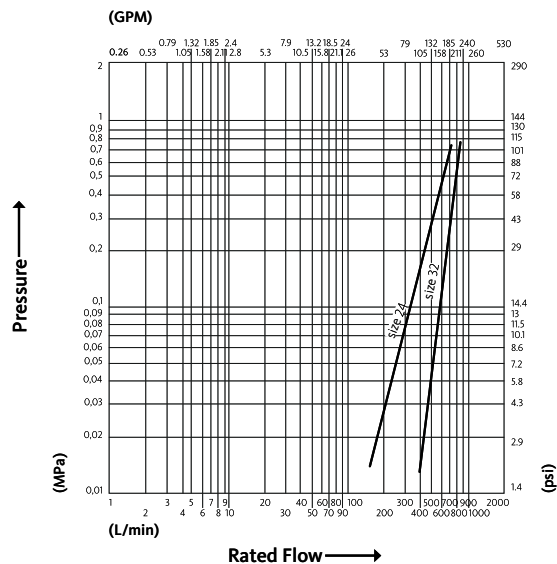

Test performed according to ISO 18869

Technical Specifications

dash	Size		Working Pressure (MPa)	Flow Rate (l/min)	Spillage (ml)	Force to Connect (N)	Burst pressure (MPa)		
	mm	inch					Male	Female	Male + Female
24	37.5	1-1/2"	35	330	41	160	176	170	
32	50	2"	35	570	80	125	130	125	

Material	Steel
Seals	NBR; PUR
Working temperatures	- 25 °C to + 100 °C
Surface treatment	MATE 500 (CrIII)
Series Interchange	MARKET

Valve Type	Poppet
Connection	Screw to Connect
Disconnection	Unscrew to Disconnect
Connection Under Pressure	Allowed Residual



OGVST

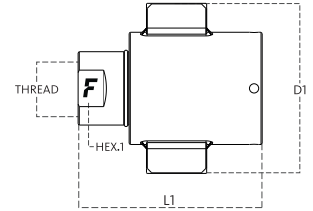

Size		Thread details			FEMALE						
mm	inch	Thread Type	Standard	Thread	Part Number	L (L1 + Thread)		D1		HEX1	
						mm	inch	mm	inch	mm	inch
37.5	1-1/2"	F BSPP	ISO 1179-1	BSPP 1-1/2" FEMALE	OGV24 112GAS F ST	159.1	6.26	147	5.79	55	2.17
50	2"	F BSPP	ISO 1179-1	BSPP 2" FEMALE	OGV32 2GAS F ST	186.4	7.34	170	6.69	75	2.95

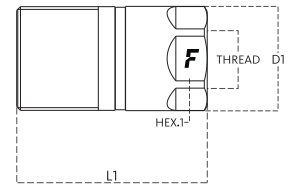

Size		Thread details			MALE						
mm	inch	Thread Type	Standard	Thread	Part Number	L (L1 + Thread)		D1		HEX1	
						mm	inch	mm	inch	mm	inch
37.5	1-1/2"	F BSPP	ISO 1179-1	BSPP 1-1/2" FEMALE	OGV24 112GAS M ST	151.7	5.97	83	3.27	75	2.95
50	2"	F BSPP	ISO 1179-1	BSPP 2" FEMALE	OGV32 2GAS M ST	179.1	7.05	103	6.69	75	2.95

OGV Accessories and Spares



Aluminium dust protections

page 252

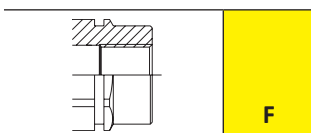

Check Valves and Diagnostic



Non-returning valves used to control the oil flow in just one direction.
Diagnostic: couplings used to check various points of the hydraulic system.

VU	page 195
VUC	page 199
DF	page 203
Couplings Accessories	page 242



VU

Standard check valves.

Check valves acting as a safety device into hydraulic systems. Standard versions contain a spring set to open the valve at 35 KPa; the range of settings is wide (up to 950 kPa). Normally available with inlet and outlet female threads.



Applications



Pressure Drop

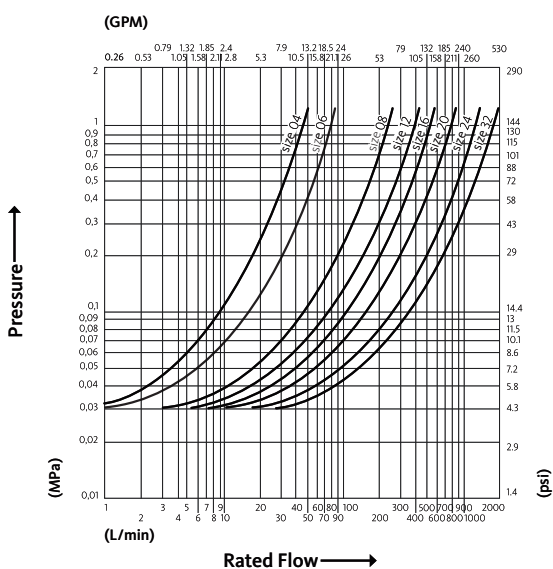

Test performed according to ISO 18869

Technical Specifications

dash	Size mm	inch	Working Pressure (MPa)	Flow Rate (l/min)	Spillage (ml)	Force to Connect (N)	Burst pressure (MPa)		
							Male	Female	Male + Female
04	6.3	1/4"	50	17				200	
06	10	3/8"	27	30				110	
08	12.5	1/2"	35	90				140	
12	20	3/4"	25	140				100	
16	25	1"	25	200				100	
20	31.5	1-1/4"	25	300				100	
24	37.5	1-1/2"	20	500				80	
32	50	2"	13	700				52	

Material	Steel
Seals	NBR
Working temperatures	- 25 °C to + 125 °C
Surface treatment	MATE 500 (CrIII)
Series Interchange	

Valve Type	Poppet
Connection	
Disconnection	
Connection Under Pressure	

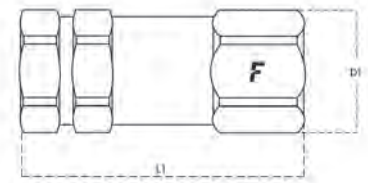

Thread details in the first line are referred to Thread 1, thread details in the second line are referred to Thread 2 - outlet.

Size		Thread details			Part Number	L (L1 + Thread)		D1		HEX1		Pressure
mm	inch	Thread Type	Standard	Thread		mm	inch	mm	inch	mm	inch	Cracking Pressure
6.3	1/4"	27/ SAE	ISO 8434-3	9/16"-18 UNF FEMALE	VUS27/CS11/CSBS	54	2.13	19	0.75	17	0.67	50 kPa
		11/ SAE	ISO 8434-3	9/16" – 18 UNF MALE								
6.3	1/4"	27/ SAE	ISO 8434-3	9/16"-18 UNF FEMALE	VUJ27/CS11/CSBS *	54	2.13	19	0.75	17	0.67	50 kPa
		11/ SAE	ISO 8434-3	9/16" – 18 UNF MALE								
6.3	1/4"	16/ BSPP	ISO 8434-6	60° 1/4 BSPP MALE	VU14M 14M	50	1.97	24.5	0.96	22	0.87	35 kPa
6.3	1/4"	F NPTF	ANSI B1.20.3	NPTF 1/4" FEMALE	VU14FN 14FN	50	1.97	21	0.83	19	0.75	35 kPa
6.3	1/4"	F BSPP	ISO 1179-1	BSPP 1/4" FEMALE	VU14F 14F C	50	1.97	21	0.83	19	0.75	100 kPa
6.3	1/4"	F BSPP	ISO 1179-1	BSPP 1/4" FEMALE	VU14F 14F B	50	1.97	21	0.83	19	0.75	50 kPa
6.3	1/4"	F BSPP	ISO 1179-1	BSPP 1/4" FEMALE	VU14F 14F A2	50	1.97	21	0.83	19	0.75	20 kPa
6.3	1/4"	F BSPP	ISO 1179-1	BSPP 1/4" FEMALE	VU14F 14F	50	1.97	21	0.83	19	0.75	35 kPa
10	3/8"	16/ BSPP	ISO 8434-6	60° 3/8 BSPP MALE	VU38M 38M V	50	1.97	24.5	0.96	22	0.87	35 kPa
10	3/8"	16/ BSPP	ISO 8434-6	60° 3/8 BSPP MALE	VU38M 38M	50	1.97	24.5	0.96	22	0.87	35 kPa
10	3/8"	F NPTF	ANSI B1.20.3	NPTF 3/8" FEMALE	VU38FN 38MN	58.1	2.29	24.5	0.96	22	0.87	35 kPa
10	3/8"	F NPTF	ANSI B1.20.3	NPTF 3/8" FEMALE	VU38FN 38FN	60	2.36	27	1.06	24	0.94	35 kPa
10	3/8"	F BSPP	ISO 1179-1	BSPP 3/8" FEMALE	VU38F 38F B	60	2.36	27	1.06	24	0.94	50 kPa
10	3/8"	F BSPP	ISO 1179-1	BSPP 3/8" FEMALE	VU38F 38F	60	2.36	27	1.06	24	0.94	35 kPa
12.5	1/2"	01/ SAE	ISO 11926-3	3/4"-16 UNF MALE	VU41/FS-11/HS I	63.5	2.5	30	1.18	27	1.06	400 kPa
12.5	1/2"	01/ SAE	ISO 11926-3	3/4"-16 UNF MALE	VU41/FS-11/HS E	63.5	2.5	30	1.18	27	1.06	200 kPa
12.5	1/2"	01/ SAE	ISO 11926-3	3/4"-16 UNF MALE	VU41/FS-11/HS C	63.5	2.5	30	1.18	27	1.06	100 kPa
12.5	1/2"	35/ SAE	ISO 8434-3	13/16"-16 UN FEMALE ORFS	VU27/FS-11/FS B	59.5	2.34	30	1.18	27	1.06	50 kPa
12.5	1/2"	01/ BSPP	ISO 1179-3	1/2" BSPP MALE	VU21/DG-11/HS I	64.6	2.54	30	1.18	27	1.06	400 kPa
12.5	1/2"	02/ METRIC	ISO 8434-1-L	M22x1.5 MALE 15L	VU2/FM-3/GM	120	4.72	30	1.18	27	1.06	35 kPa
12.5	1/2"	02/ METRIC	ISO 8434-1-L	M18x1.5 MALE 12L	VU2/DM-2/DM H	52.4	2.06	30	1.18	27	1.06	350 kPa
12.5	1/2"	13/ SAE	ISO 8434-2	7/8"-14 UNF MALE JIC	VU13/GS-1/GS H	66.7	2.63	30	1.18	27	1.06	350 kPa
12.5	1/2"	13/ SAE	ISO 8434-2	3/4"-16 UNF MALE JIC	VU13/FS-28/FS B	64	2.52	30	1.18	27	1.06	50 kPa
12.5	1/2"	F NPTF	ANSI B1.20.3	NPTF 1/2" FEMALE	VU12M 12M M	56	2.2	30	1.18	27	1.06	500 kPa
12.5	1/2"	F NPTF	ANSI B1.20.3	NPTF 1/2" FEMALE	VU12FN 12FN M	70	2.76	30	1.18	27	1.06	500 kPa
12.5	1/2"	F NPTF	ANSI B1.20.3	NPTF 1/2" FEMALE	VU12FN 12FN	70	2.76	30	1.18	27	1.06	35 kPa
12.5	1/2"	F BSPP	ISO 1179-1	BSPP 1/2" FEMALE	VU12F 12F M	70	2.76	30	1.18	27	1.06	500 kPa
12.5	1/2"	F BSPP	ISO 1179-1	BSPP 1/2" FEMALE	VU12F 12F C	70	2.76	30	1.18	27	1.06	100 kPa
12.5	1/2"	F BSPP	ISO 1179-1	BSPP 1/2" FEMALE	VU12F 12F B	70	2.76	30	1.18	27	1.06	50 kPa
12.5	1/2"	01/ BSPP	ISO 1179-3	3/8" BSPP MALE	VU1/CG-11/HS I	62.6	2.46	30	1.18	27	1.06	400 kPa
12.5	1/2"	01/ BSPP	ISO 1179-3	3/8" BSPP MALE	VU1/CG-11/HS G	62.6	2.46	30	1.18	27	1.06	300 kPa
12.5	1/2"	01/ BSPP	ISO 1179-3	3/8" BSPP MALE	VU1/CG-11/HS E	62.6	2.46	30	1.18	27	1.06	200 kPa
12.5	1/2"	01/ BSPP	ISO 1179-3	3/8" BSPP MALE	VU1/CG-11/HS C	62.6	2.46	30	1.18	27	1.06	100 kPa
12.5	1/2"	16/ BSPP	ISO 8434-6	60° 1/2 BSPP MALE	VU12M 12M	56	2.2	30	1.18	27	1.06	35 kPa
12.5	1/2"	F BSPP	ISO 1179-1	BSPP 1/2" FEMALE	VU12F 12F	70	2.76	30	1.18	27	1.06	35 kPa
20	3/4"	01/ SAE	ISO 11926-3	7/8"-14 UNF MALE	VU41/GS-11/GS I	70.3	2.77	42	1.65	38	1.5	400 kPa
20	3/4"	0/ SAE	ISO 11926-1	1-1/16"-12 UN FEMALE ORB	VU34FS 34FS	88	3.46	40	1.57	36	1.42	35 kPa
20	3/4"	F NPTF	ANSI B1.20.3	NPTF 3/4" FEMALE	VU34FN 34FN M	86	3.39	38	1.5	34	1.34	500 kPa
20	3/4"	F NPTF	ANSI B1.20.3	NPTF 3/4" FEMALE	VU34FN 34FN	86	3.39	38	1.5	34	1.34	35 kPa
20	3/4"	F BSPP	ISO 1179-1	BSPP 3/4" FEMALE	VU34F 34F V	86	3.39	38	1.5	34	1.34	35 kPa
20	3/4"	F BSPP	ISO 1179-1	BSPP 3/4" FEMALE	VU34F 34F B	86	3.39	38	1.5	34	1.34	50 kPa

VU

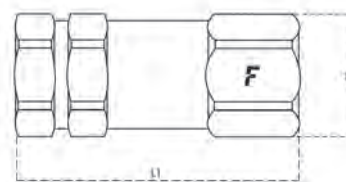

Thread details in the first line are referred to Thread 1, thread details in the second line are referred to Thread 2 - outlet.

Size		Thread details			Part Number	L (L1 + Thread)		D1		HEX1		Pressure
mm	inch	Thread Type	Standard	Thread		mm	inch	mm	inch	mm	inch	Cracking Pressure
20	3/4"	02/ METRIC	ISO 8434-1-L	M26x1.5 MALE 18L	VU2/HM-2/HM H	58.4	2.3	42	1.65	38	1.5	350 kPa
20	3/4"	01/ SAE	ISO 11926-3	1-1/16"-12 UN MALE	VU1/HS-11/LS P	70	2.76	42	1.65	38	1.5	600 kPa
20	3/4"	01/ SAE	ISO 11926-3	1-1/16"-12 UN MALE	VU1/HS-11/LS G	70	2.76	42	1.65	38	1.5	300 kPa
20	3/4"	F BSPP	ISO 1179-1	BSPP 3/4" FEMALE	VU34F 34F	86	3.39	38	1.5	34	1.34	35 kPa
25	1"	F NPTF	ANSI B1.20.3	NPTF 1" FEMALE	VU 1FN 1FN	100	3.94	44	1.73	41	1.61	35 kPa
25	1"	F BSPP	ISO 1179-1	BSPP 1" FEMALE	VU 1F 1F U	100	3.94	44	1.73	41	1.61	800 kPa
25	1"	F BSPP	ISO 1179-1	BSPP 1" FEMALE	VU 1F 1F M	100	3.94	44	1.73	41	1.61	500 kPa
25	1"	F BSPP	ISO 1179-1	BSPP 1" FEMALE	VU 1F 1F L	100	3.94	44	1.73	41	1.61	450 kPa
25	1"	F BSPP	ISO 1179-1	BSPP 1" FEMALE	VU 1F 1F G	100	3.94	44	1.73	41	1.61	300 kPa
25	1"	F BSPP	ISO 1179-1	BSPP 1" FEMALE	VU 1F 1F E	100	3.94	44	1.73	41	1.61	200 kPa
25	1"	F BSPP	ISO 1179-1	BSPP 1" FEMALE	VU 1F 1F B	100	3.94	44	1.73	41	1.61	50 kPa
25	1"	F BSPP	ISO 1179-1	BSPP 1" FEMALE	VU 1F 1F	100	3.94	44	1.73	41	1.61	35 kPa
31.5	1-1/4"	F NPTF	ANSI B1.20.3	NPTF 1-1/4" FEMALE	VU114FN 114FN L	130	5.12	55	2.17	50	1.97	450 kPa
31.5	1-1/4"	F NPTF	ANSI B1.20.3	NPTF 1-1/4" FEMALE	VU114FN 114FN	130	5.12	55	2.17	50	1.97	35 kPa
31.5	1-1/4"	F BSPP	ISO 1179-1	BSPP 1-1/4" FEMALE	VU114F 114F M	130	5.12	55	2.17	50	1.97	500 kPa
31.5	1-1/4"	F BSPP	ISO 1179-1	BSPP 1-1/4" FEMALE	VU114F 114F E	130	5.12	55	2.17	50	1.97	200 kPa
31.5	1-1/4"	F BSPP	ISO 1179-1	BSPP 1-1/4" FEMALE	VU114F 114F C	130	5.12	55	2.17	50	1.97	100 kPa
31.5	1-1/4"	F BSPP	ISO 1179-1	BSPP 1-1/4" FEMALE	VU114F 114F	130	5.12	55	2.17	50	1.97	35 kPa
31.5	1-1/4"	F BSPP	ISO 1179-1	BSPP 1-1/4" FEMALE	VU114F 114F B	130	5.12	55	2.17	50	1.97	50 kPa
37.5	1-1/2"	F BSPP	ISO 1179-1	BSPP 1-1/2" FEMALE	VU112F 112F U	145	5.71	66	2.6	60	2.36	800 kPa
37.5	1-1/2"	F BSPP	ISO 1179-1	BSPP 1-1/2" FEMALE	VU112F 112F I	145	5.71	66	2.6	60	2.36	400 kPa
37.5	1-1/2"	F BSPP	ISO 1179-1	BSPP 1-1/2" FEMALE	VU112F 112F	145	5.71	66	2.6	60	2.36	35 kPa
37.5	1-1/2"	F BSPP	ISO 1179-1	BSPP 1-1/2" FEMALE	VU112F 112F M	145	5.71	66	2.6	60	2.36	500 kPa
50	2"	F BSPP	ISO 1179-1	BSPP 2" FEMALE	VU 2F 2F I	160	6.3	90	3.54	75	2.95	400 kPa
50	2"	F BSPP	ISO 1179-1	BSPP 2" FEMALE	VU 2F 2F C	160	6.3	90	3.54	75	2.95	100 kPa
50	2"	F BSPP	ISO 1179-1	BSPP 2" FEMALE	VU 2F 2F	160	6.3	90	3.54	75	2.95	35 kPa

* O-ring for ORFS outlet adaptor (Faster code 11/..) is in NBR, hardness 90° Shore A.
Part number ending in V have seals in FKM and consequently a Working Temperature of -20 °C + 200 °C.

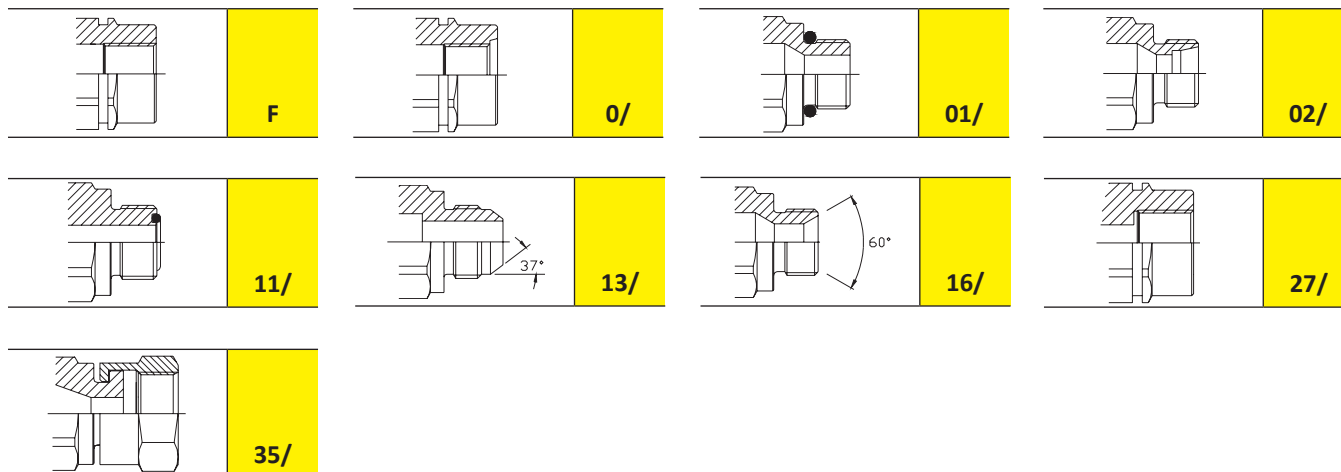



VUC

Compact check valves.

VUC series check valves are very compact being them assembled with only one piece body. Standard cracking pressure 35 kPa.



Applications



Pressure Drop

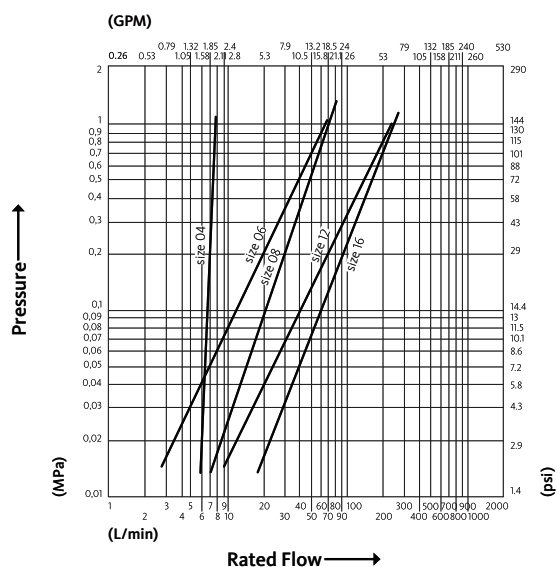

Technical Specifications

dash	Size mm	inch	Working Pressure (MPa)	Flow Rate (l/min)	Spillage (ml)	Force to Connect (N)	Burst pressure (MPa)		
							Male	Female	Male + Female
04	6.3	1/4"	25	5				100	
06	10	3/8"	40	20				160	
08	12.5	1/2"	40	35				160	
12	20	3/4"	40	65				160	
16	25	1"	40	90				160	

Material	Steel
Seals	NBR
Working temperatures	- 25 °C to + 125 °C
Surface treatment	MATE 500 (CrIII)
Series Interchange	

Valve Type	Poppet
Connection	
Disconnection	
Connection Under Pressure	

VUC

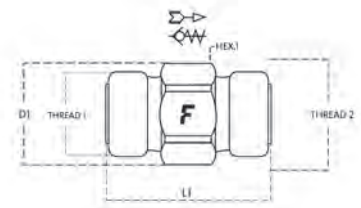

Thread details in the first line are referred to Thread 1, thread details in the second line are referred to Thread 2 - outlet.

Size		Thread details			Pressure							
mm	inch	Thread Type	Standard	Thread	Part Number	L (L1 + Thread)		D1		HEX1		Cracking Pressure
						mm	inch	mm	inch	mm	inch	
6.3	1/4"	41/ METRIC	ISO 6149-2	M12X1.5 MALE	VUC41/AM-2/CM	55.5	2.19	21	0.83	19	0.75	35 kPa
		02/ METRIC	ISO 8434-1-L	M16x1.5 MALE 12L								
6.3	1/4"	02/ METRIC	ISO 8434-1-L	M18x1.5 MALE 12L	VUC2/DM-41/BM	32	1.26	21	0.83	19	0.75	35 kPa
		41/ METRIC	ISO 6149-2	M14X1.5 MALE								
10	3/8"	11/ SAE	ISO 8434-3	9/16" - 18 UNF MALE	VUC11/CS-1/ES E	31.6	1.24	21	0.83	19	0.75	200 kPa
		01/ SAE	ISO 11926-3	9/16"-18 UNF MALE								
10	3/8"	13/ SAE	ISO 8434-2	9/16"-18 UNF MALE JIC	VUC13/ES28/ESZZ	40.5	1.59	21	0.83	19	0.75	1900 kPa
		28/ SAE	ISO 8434-2	9/16"-18 UNF FEMALE								
10	3/8"	13/ SAE	ISO 8434-2	9/16"-18 UNF MALE JIC	VUC13/ES28/ESA2	40.5	1.59	21	0.83	19	0.75	20 kPa
		28/ SAE	ISO 8434-2	9/16"-18 UNF FEMALE								
10	3/8"	11/ SAE	ISO 8434-3	13/16"-16 UN MALE ORFS	VUC11/FS-11/ES	33.6	1.32	24	0.94	22	0.87	35 kPa
		11/ SAE	ISO 8434-3	11/16"-16 UN MALE ORFS								
10	3/8"	11/ SAE	ISO 8434-3	11/16"-16 UN MALE ORFS	VUC11/ES-41/BM	35.9	1.41	21	0.83	19	0.75	35 kPa
		41/ METRIC	ISO 6149-2	M14X1.5 MALE								
10	3/8"	11/ SAE	ISO 8434-3	11/16"-16 UN MALE ORFS	VUC11/ES-11/FS	33.6	1.32	24	0.94	22	0.87	35 kPa
		11/ SAE	ISO 8434-3	13/16"-16 UN MALE ORFS								
10	3/8"	11/ SAE	ISO 8434-3	11/16"-16 UN MALE ORFS	VUC11/ES-11/ES	33.6	1.32	21	0.83	19	0.75	35 kPa
		11/ SAE	ISO 8434-3	11/16"-16 UN MALE ORFS								
10	3/8"	11/ SAE	ISO 8434-3	11/16"-16 UN MALE ORFS	VUC11/ES-1/ES	32.6	1.28	21	0.83	19	0.75	35 kPa
		01/ SAE	ISO 11926-3	9/16"-18 UNF MALE								
10	3/8"	01/ METRIC	ISO 6149-2	M18x1.5 MALE	VUC1/DM-11/ES	41	1.61	26	1.02	24	0.94	35 kPa
		11/ SAE	ISO 8434-3	11/16"-16 UN MALE ORFS								
10	3/8"	01/ METRIC	ISO 6149-2	M14x1.5 MALE	VUC1/BM-11/ESA2	35.9	1.41	21	0.83	19	0.75	20 kPa
		11/ SAE	ISO 8434-3	11/16"-16 UN MALE ORFS								
12.5	1/2"	01/ SAE	ISO 11926-3	3/4"-16 UNF MALE	VUC1/FS-11/FSX	38.1	1.5	26	1.02	24	0.94	850 kPa
		11/ SAE	ISO 8434-3	13/16"-16 UN MALE ORFS								
12.5	1/2"	01/ SAE	ISO 11926-3	3/4"-16 UNF MALE	VUC1/FS-11/FSC	38.1	1.5	26	1.02	24	0.94	100 kPa
		11/ SAE	ISO 8434-3	13/16"-16 UN MALE ORFS								
12.5	1/2"	01/ METRIC	ISO 6149-2	M18x1.5 MALE	VUC1/DM-11/FSB1	43	1.69	26	1.02	24	0.94	70 kPa
		11/ SAE	ISO 8434-3	13/16"-16 UN MALE ORFS								
12.5	1/2"	01/ METRIC	ISO 6149-2	M18x1.5 MALE	VUC1/DM-11/FS	43	1.69	26	1.02	24	0.94	35 kPa
		11/ SAE	ISO 8434-3	13/16"-16 UN MALE ORFS								

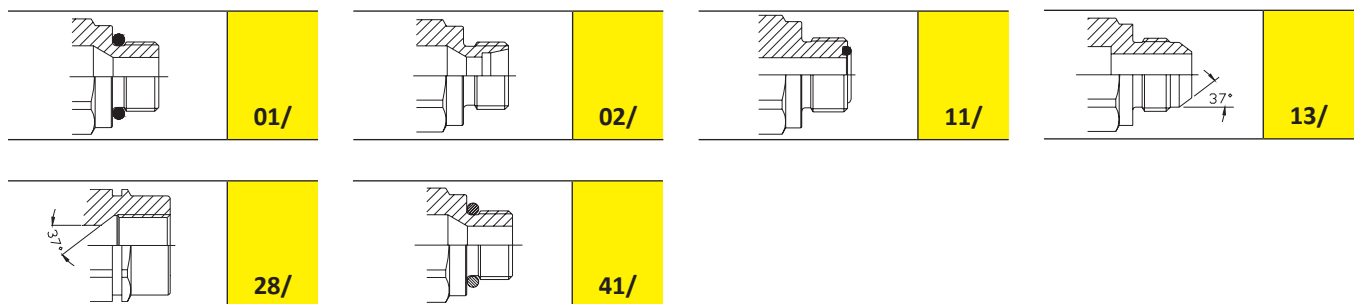

VUC

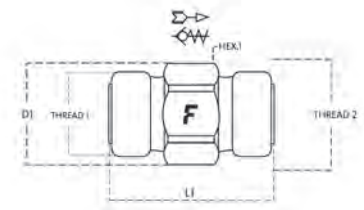

Thread details in the first line are referred to Thread 1, thread details in the second line are referred to Thread 2 - outlet.

Size		Thread details									Pressure	
mm	inch	Thread Type	Standard	Thread	Part Number	L (L1 + Thread)		D1		HEX1		Cracking Pressure
						mm	inch	mm	inch	mm	inch	
20	3/4"	13/ SAE	ISO 8434-2	1-1/16"-12 UN MALE JIC	VUC13/HS13/HSA2	50	1.97	25	0.98	32	1.26	20 kPa
		13/ SAE	ISO 8434-2	1-1/16"-12 UN MALE JIC								
20	3/4"	01/ SAE	ISO 11926-3	1-1/16"-12 UN MALE	VUC1/HS-11/HSE	46.1	1.81	35	1.38	32	1.26	200 kPa
		11/ SAE	ISO 8434-3	1-3/16"-12 UN MALE ORFS								
25	1"	01/ BSPP	BS 5380	G 1"	VUS1/GG-1/GG G	60	2.36	45	1.77	41	1.61	300 kPa
25	1"	11/ SAE	ISO 8434-3	1-7/16"-12 UN MALE ORFS	VUC11/LS11/LSZC	50.5	1.99	42	1.65	38	1.5	1030 kPa
		11/ SAE	ISO 8434-3	1-7/16"-12 UN MALE ORFS								
25	1"	11/ SAE	ISO 8434-3	1-7/16"-12 UN MALE ORFS	VUC11/LS-11/LS	50.5	1.99	42	1.65	38	1.5	35 kPa
		11/ SAE	ISO 8434-3	1-7/16"-12 UN MALE ORFS								
25	1"	01/ METRIC	ISO 6149-2	M33x2 MALE	VUC1/MM-11/MSA1	72.6	2.86	54	2.13	48	1.89	15 kPa
		11/ SAE	ISO 8434-3	1-11/16"-12 UN MALE ORFS								
25	1"	01/ METRIC	ISO 6149-2	M33x2 MALE	VUC1/MM-11/MS	72.6	2.86	54	2.13	48	1.89	35 kPa
		11/ SAE	ISO 8434-3	1-11/16"-12 UN MALE ORFS								

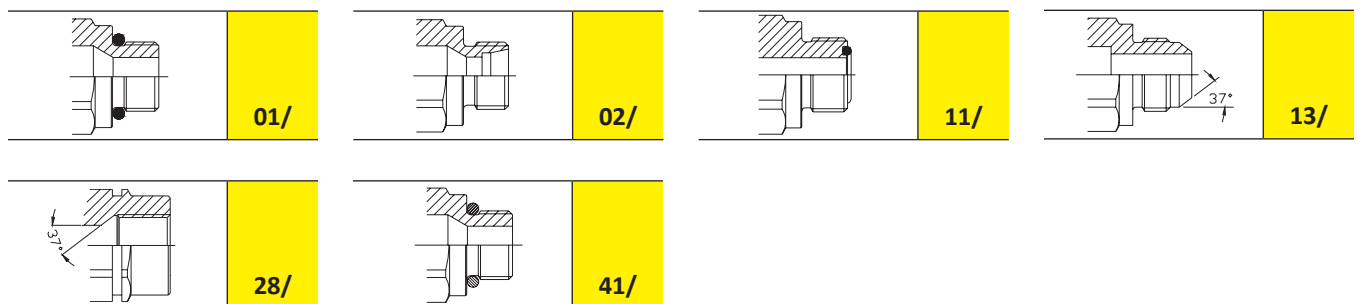

DF



Diagnostic couplings, ISO 15171-1 interchange.

Flat face couplings specifically designed to measure the internal pressure of hydraulic circuits. Male part to be mounted on the hydraulic line and female part to be connected to gauge instruments. ISO 15171-1 interchange.



Applications



Pressure Drop

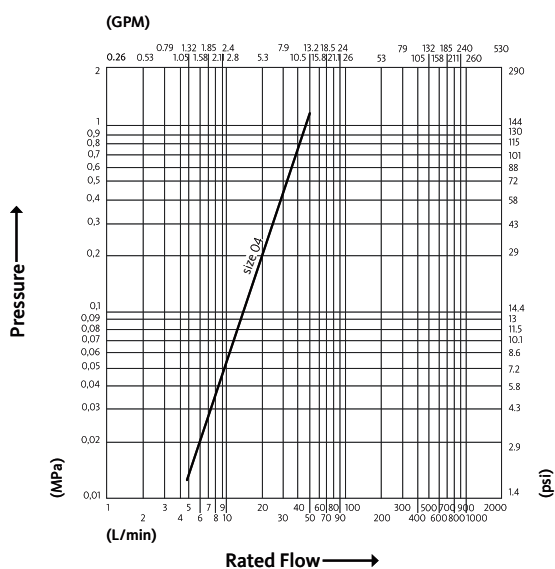

Test performed according to ISO 18869

Technical Specifications

dash	Size mm	inch	Working Pressure (MPa)	Flow Rate (l/min)	Spillage (ml)	Force to Connect (N)	Burst pressure (MPa)		
							Male	Female	Male + Female
04	6.3	1/4"	47	2	0.01	70	190	150	180

Material	Steel
Seals	NBR
Working temperatures	- 25 °C to + 125 °C
Surface treatment	MATE 500 (CrIII)
Series Interchange	ISO 15171-1

Valve Type	Flat
Connection	Push to Connect
Disconnection	Sleeve Retraction
Connection Under Pressure	Not Allowed

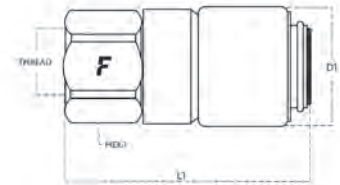

DF

Size		Thread details			FEMALE						
mm	inch	Thread Type	Standard	Thread	Part Number	L (L1 + Thread)		D1		HEX1	
						mm	inch	mm	inch	mm	inch
6.3	1/4"	O/ METRIC	ISO 6149-1	M14x1.5 FEMALE ORB	DF04-0/1415 F	51.5	2.03	24	0.94	21	0.83
6.3	1/4"	O/ SAE	ISO 11926-1	9/16"-18 UNF FEMALE ORB	DF 04-38SAE F	54	2.13	23.5	0.93	21	0.83
6.3	1/4"	O/ SAE	ISO 11926-1	7/16"-20 UNF FEMALE ORB	DF 04-14SAE F	54	2.13	23.5	0.93	21	0.83
6.3	1/4"	F BSPP	ISO 1179-1	BSPP 1/4" FEMALE	DF 04-14GAS F	52.5	2.07	24	0.94	21	0.83
6.3	1/4"	O1/ NPTF	ANSI B1.20.3	1/4" NPTF MALE	DF 04-1/14NPT F	56	2.2	24	0.94	21	0.83
6.3	1/4"	F NPTF	ANSI B1.20.3	NPTF 1/8" FEMALE	DF 04-18NPT F	42	1.65	24	0.94	21	0.83
6.3	1/4"	F NPTF	ANSI B1.20.3	NPTF 1/4" FEMALE	DF 04-14NPT F	50	1.97	24	0.94	21	0.83

DF Accessories and Spares

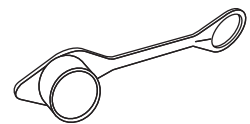

PVC dust protections

page 243

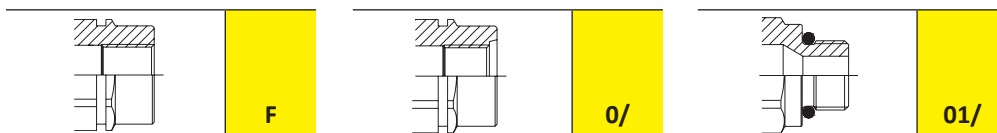

DF

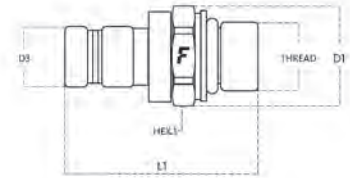

Size		Thread details			MALE									
mm	inch	Thread Type	Standard	Thread	Part Number	L (L1 + Thread)		D1		D3		HEX1		
						mm	inch	mm	inch	mm	inch	mm	inch	
6.3	1/4"	21/ BSPP	ISO 1179-2	1/8" BSPP MALE	DF04-21/18G M	40.8	1.61	19	0.75	12.55	0.49	17	0.67	
6.3	1/4"	35/ SAE	ISO 8434-3	11/16"-16 UN FEMALE ORFS	DF04-35/38SAEM	35.4	1.39	24	0.94	12.55	0.49	22	0.87	
6.3	1/4"	35/ SAE	ISO 8434-3	13/16"-16 UN FEMALE ORFS	DF04-35/12SAEM	39.1	1.54	26	1.02	12.55	0.49	24	0.94	
6.3	1/4"	29/ SAE	ISO 8434-2	3/4"-16 UNF FEMALE JIC	DF04-29/12SAEM	42.6	1.68	24.5	0.96	12.55	0.49	22	0.87	
6.3	1/4"	28/ SAE	ISO 8434-2	9/16" -18 UNF FEMALE JIC	DF04-28/38SAEM	38.1	1.5	21	0.83	12.55	0.49	19	0.75	
6.3	1/4"	27/ SAE	ISO 8434-3	9/16"-18 UNF FEMALE	DF04-27/14SAEM	40.6	1.6	19	0.75	12.55	0.49	17	0.67	
6.3	1/4"	01/ BSPP	ISO 1179-3	1/4" BSPP MALE	DF04-21/14G M	44.9	1.77	21	0.83	12.55	0.49	19	0.75	
6.3	1/4"	01/ METRIC	ISO 6149-2	M14x1.5 MALE	DF04-21/1415M	42.1	1.66	21	0.83	12.55	0.49	19	0.75	
6.3	1/4"	01/ METRIC	ISO 6149-2	M12x1.5 MALE	DF04-21/1215M T	44.9	1.77	21	0.83	12.55	0.49	19	0.75	
6.3	1/4"	13/ SAE	ISO 8434-2	9/16"-18 UNF MALE JIC	DF04-13/38SAEM	41.1	1.62	21	0.83	12.55	0.49	19	0.75	
6.3	1/4"	12/ SAE	ISO 8434-3	9/16"-18 UNF MALE BULKHEAD ORFS	DF04-12/14SAEM	62.2	2.45	21	0.83	12.55	0.49	19	0.75	
6.3	1/4"	01/ SAE	ISO 11926-3	1/2"-20 UNF MALE	DF04-1/516SAEM	36.1	1.42	21	0.83	12.55	0.49	19	0.75	
6.3	1/4"	01/ SAE	ISO 11926-3	9/16"-18 UNF MALE	DF04-1/38SAE M	37.1	1.46	19	0.75	12.55	0.49	17	0.67	
6.3	1/4"	01/ SAE	ISO 11926-3	3/8"-24 UNF MALE	DF04-1/316SAEMT	38.9	1.53	19	0.75	12.55	0.49	17	0.67	
6.3	1/4"	01/ NPTF	ANSI B1.20.3	1/8" NPTF MALE	DF04-1/18NPT M	40.9	1.61	19	0.75	12.55	0.49	17	0.67	
6.3	1/4"	01/ METRIC	ISO 6149-2	M18x1.5 MALE	DF04-1/1815 M	44.1	1.74	27	1.06	12.55	0.49	24	0.94	
6.3	1/4"	01/ SAE	ISO 11926-3	7/16"-20 UNF MALE	DF04-1/14SAE M	40.5	1.59	19	0.75	12.55	0.49	17	0.67	
6.3	1/4"	01/ SAE	ISO 11926-3	3/4"-16 UNF MALE	DF04-1/12SAEM T	42.5	1.67	27	1.06	12.55	0.49	24	0.94	
6.3	1/4"	0/ SAE	ISO 11926-1	9/16"-18 UNF FEMALE ORB	DF 04-38SAE M	37	1.46	19	0.75	12.55	0.49	17	0.67	
6.3	1/4"	F NPTF	ANSI B1.20.3	NPTF 1/8" FEMALE	DF 04-18NPT M	36.1	1.42	19	0.75	12.55	0.49	19	0.75	
6.3	1/4"	0/ SAE	ISO 11926-1	7/16"-20 UNF FEMALE ORB	DF 04-14SAE M	42	1.65	21	0.83	12.55	0.49	19	0.75	
6.3	1/4"	F NPTF	ANSI B1.20.3	NPTF 1/4" FEMALE	DF 04-14NPT M	40	1.57	21	0.83	12.55	0.49	19	0.75	
6.3	1/4"	01/ NPTF	ANSI B1.20.3	1/4" NPTF MALE	DF 04-1/14NPTM	41.1	1.62	21	0.83	12.55	0.49	19	0.75	
6.3	1/4"	01/ BSPP	ISO 1179-3	1/4" BSPP MALE	DF 04-1/14GASM	39.1	1.54	21	0.83	12.55	0.49	19	0.75	
6.3	1/4"	21/ BSPP	ISO 1179-2	1/8" BSPP MALE	DF04-21/18G MT	40.8	1.61	21	0.83	12.55	0.49	17	0.67	

NOTE: Part numbers ending with "T" are provided with caps.

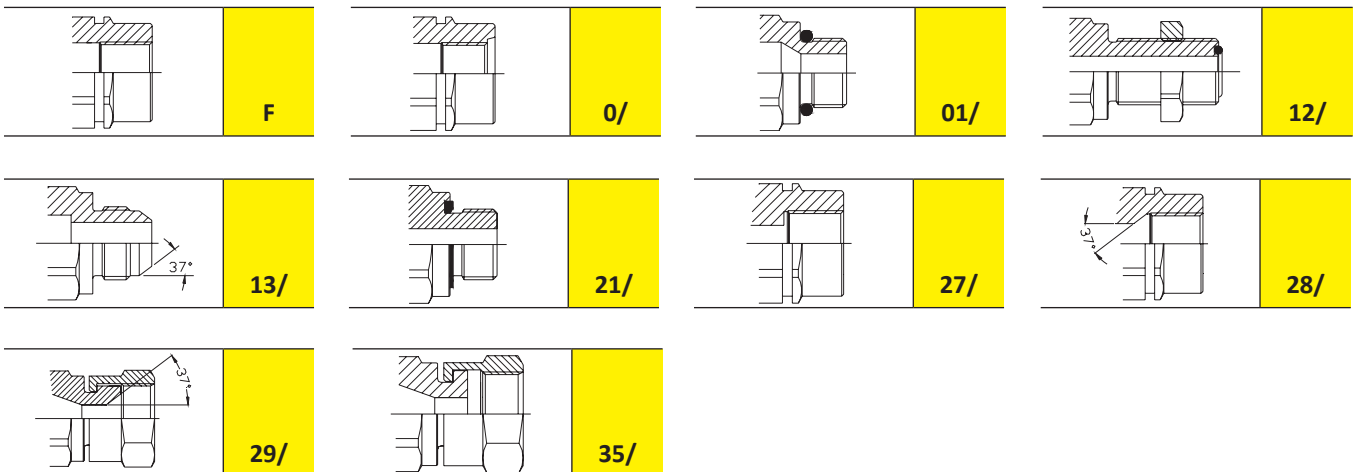

High Pressure

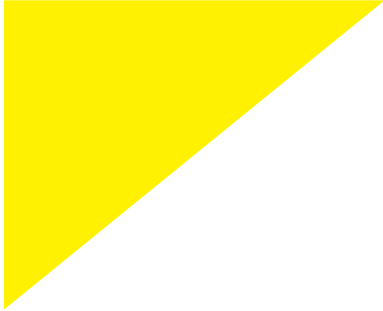

Couplings designed for high pressures applications.

PVVM	page 207
PVSM	page 209
FFHP	page 211
UHP 100	page 213
UHP 150	page 215
Couplings Accessories	page 242



PVVM

Screw to connect couplings for high pressure, ISO 14540 interchange, poppet valve.

Screw-on couplings purposely designed for the heaviest applications. Equipped with a robust metal-to-metal sealing poppet valve, this series guarantees the best performance on the market in terms of maximum working pressure. ISO 14540 interchange.



Applications



Pressure Drop

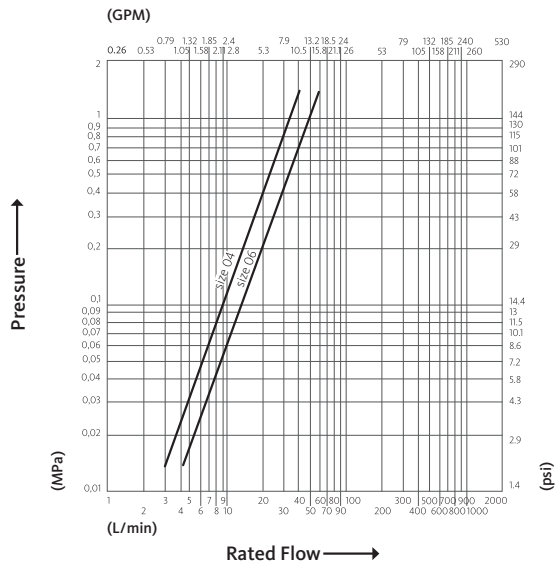

Technical Specifications

dash	Size mm	inch	Working Pressure (MPa)	Flow Rate (l/min)	Spillage (ml)	Force to Connect (N)	Burst pressure (MPa)		
							Male	Female	Male + Female
04	6.3	1/4"	103	15	0.5	0	310	330	350
06	10	3/8"	100	20	1	0	330	300	350

Material	Steel
Seals	NBR
Working temperatures	- 25 °C to + 125 °C
Surface treatment	MATE 500 (CrIII)
Series Interchange	ISO 14540

Valve Type	Poppet
Connection	Screw to Connect
Disconnection	Unscrew to Disconnect
Connection Under Pressure	Allowed Residual



PVVM

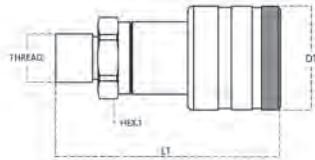

Size		Thread details			FEMALE							
mm	inch	Thread Type	Standard	Thread	Part Number	L (L1 + Thread)		D1		HEX1		
						mm	inch	mm	inch	mm	inch	
6.3	1/4"	01/ NPTF	ANSI B1.20.3	NPTF 1/4" MALE	PVVM1/14NPT F	63	2.48	33	1.3	21	0.83	
10	3/8"	23/ BSPP	n.a.	BSPP 1/4 MALE SPECIAL	PVVM38-23/14G F	147.7	5.81	36	1.42	25	0.98	
10	3/8"	01/ NPTF	ANSI B1.20.3	NPTF 1/4" MALE	PVVM38-1/14NPTF	148.7	5.85	36	1.42	25	0.98	
10	3/8"	01/ NPTF	ANSI B1.20.3	NPTF 3/8" MALE	PVVM1/38NPT F	83	3.27	36	1.42	25	0.98	

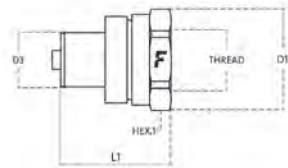

Size		Thread details			MALE								
mm	inch	Thread Type	Standard	Thread	Part Number	L (L1 + Thread)		D1		D3		HEX1	
						mm	inch	mm	inch	mm	inch	mm	inch
6.3	1/4"	F NPTF	ANSI B1.20.3	NPTF 1/4" FEMALE	PVVM 14 NPT M	34	1.34	30	1.18			27	1.06
10	3/8"	23/ BSPP	n.a.	BSPP 1/4 MALE SPECIAL	PVVM38-23/14G M	63.8	2.51	35.5	1.4			25	0.98
10	3/8"	F NPTF	ANSI B1.20.3	NPTF 3/8" FEMALE	PVVM 38 NPT M	39	1.54	35	1.38			32	1.26

PVVM Accessories and Spares

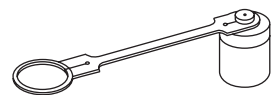
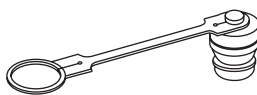

Aluminium dust protections

page 252



Seals Kits

page 262

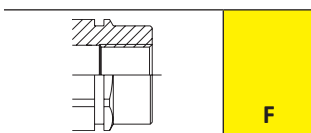

F

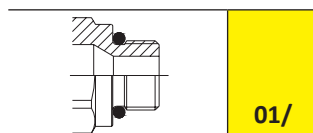

01/

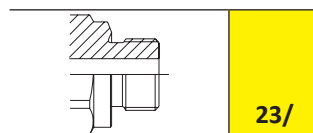

23/



PVSM

Screw to connect couplings for high pressure, ISO 14540 interchange, ball valve.

PVSM screw to connect couplings have been purposely designed for the heaviest applications in terms of working pressure. Equipped with a metal-to-metal sealing ball valve they are interchangeable according to ISO 14540 standards.



Applications



Pressure Drop

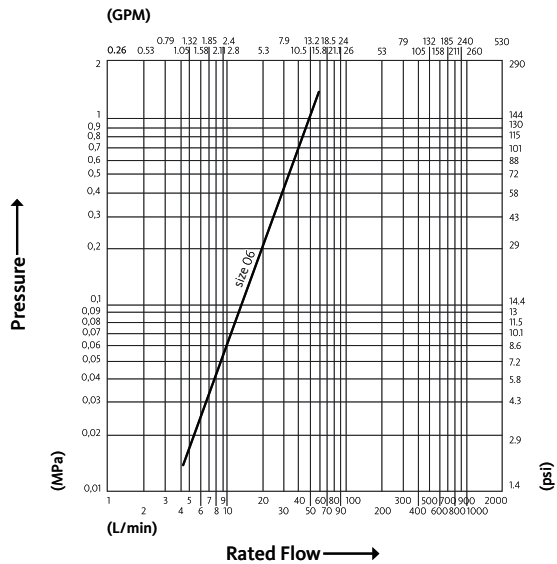

Technical Specifications

dash	Size mm	inch	Working Pressure (MPa)	Flow Rate (l/min)	Spillage (ml)	Force to Connect (N)	Burst pressure (MPa)		
							Male	Female	Male + Female
06	10	3/8"	72	14	1	0	144	180	260

Material	Steel
Seals	NBR
Working temperatures	- 25 °C to + 125 °C
Surface treatment	MATE 500 (CrIII)
Series Interchange	ISO 14540

Valve Type	Ball
Connection	Screw to Connect
Disconnection	Unscrew to Disconnect
Connection Under Pressure	Allowed Residual



PVSM

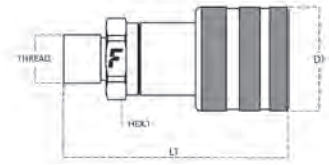

Size		Thread details			FEMALE						
mm	inch	Thread Type	Standard	Thread	Part Number	L (L1 + Thread)		D1		HEX1	
						mm	inch	mm	inch	mm	inch
10	3/8"	01/ NPTF	ANSI B1.20.3	NPTF 3/8" MALE	PVSM1/38NPT F	77.5	3.05	36	1.42	25	0.98

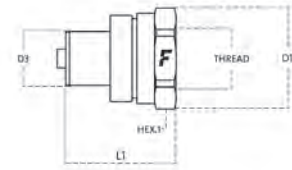

Size		Thread details			MALE								
mm	inch	Thread Type	Standard	Thread	Part Number	L (L1 + Thread)		D1		D3		HEX1	
						mm	inch	mm	inch	mm	inch	mm	inch
10	3/8"	F NPTF	ANSI B1.20.3	NPTF 3/8" FEMALE	PVSM 38 NPT M	39	1.54	35.5	1.4	19	0.75	32	1.26

PVSM Accessories and Spares

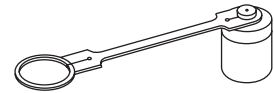
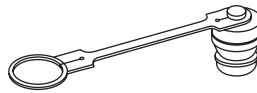

Aluminium dust protections

page 252



Seals Kits

page 262





FFHP

Flat face couplings, high pressure.

Flat Face coupling with real maximum working pressure up to 72 Mpa, suitable for very high pressure application. Very good resistance to wear and corrosion. Market interchangeable.



Applications



Pressure Drop

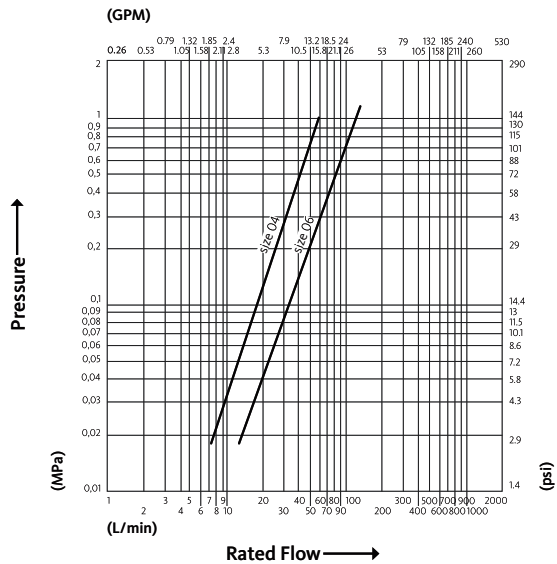

Technical Specifications

dash	Size		Working Pressure (MPa)	Flow Rate (l/min)	Spillage (ml)	Force to Connect (N)	Burst pressure (MPa)		
	mm	inch					Male	Female	Male + Female
04	6.3	1/4"	72	25	0.01	110	216	150	216
06	10	3/8"	72	46	0.02	200	216	125	216

Material	Steel
Seals	NBR; PUR
Working temperatures	- 25 °C to + 100 °C
Surface treatment	MATE 1000 (Zn-Ni)
Series Interchange	MARKET

Valve Type	Flat
Connection	Push to Connect
Disconnection	Sleeve Retraction
Connection Under Pressure	Not Allowed



FFHP

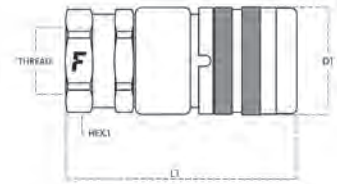

Size		Thread details			FEMALE						
mm	inch	Thread Type	Standard	Thread	Part Number	L (L1 + Thread)		D1		HEX1	
						mm	inch	mm	inch	mm	inch
6.3	1/4"	F NPTF	ANSI B1.20.3	NPTF 1/4" FEMALE	FFHP04 14NPT F	58.9	2.32	29.2	1.15	24	0.94
10	3/8"	F NPTF	ANSI B1.20.3	NPTF 3/8" FEMALE	FFHP06 38NPT F	75.1	2.96	32.2	1.27	27	1.06

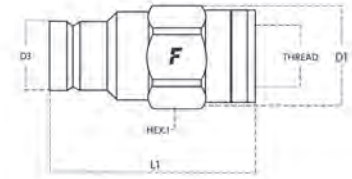

Size		Thread details			MALE								
mm	inch	Thread Type	Standard	Thread	Part Number	L (L1 + Thread)		D1		D3		HEX1	
						mm	inch	mm	inch	mm	inch	mm	inch
6.3	1/4"	F NPTF	ANSI B1.20.3	NPTF 1/4" FEMALE	FFHP04 14NPT M	49	1.93	26	1.02	16.5	0.65	24	0.94
10	3/8"	F NPTF	ANSI B1.20.3	NPTF 3/8" FEMALE	FFHP06 38NPT M	68.3	2.69	33	1.3	19.45	0.77	30	1.18

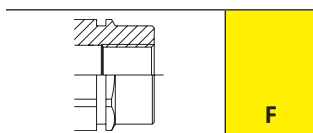

UHP 100



Couplings for Ultra High Pressure applications (100 MPa series).

UHP couplings are the most advanced Faster solution for hydraulic applications with ultra high working pressures of 100 MPa and more. Very robust and reliable, they are characterized by redundant visual and mechanical safety systems.



Applications



Pressure Drop

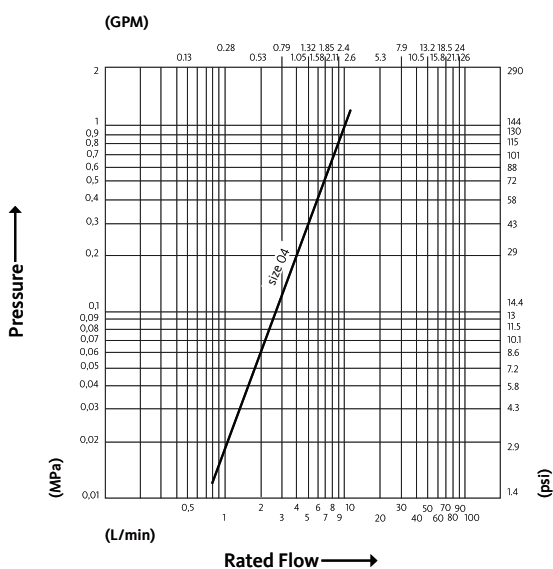

Test performed according to ISO 18869

Technical Specifications

dash	Size mm	inch	Working Pressure (MPa)	Flow Rate (l/min)	Spillage (ml)	Force to Connect (N)	Burst pressure (MPa)		
							Male	Female	Male + Female
04	6.3	1/4"	100	4	0.008	50	300	300	300

Material	Steel
Seals	NBR
Working temperatures	- 25 °C to + 100 °C
Surface treatment	MATE 500 - 1000 (Zn-Ni)
Series Interchange	MARKET

Valve Type	Poppet
Connection	Sleeve Retraction
Disconnection	Sleeve Retraction
Connection Under Pressure	Not Allowed



UHP 100

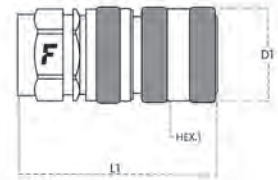

Size		Thread details			FEMALE						
mm	inch	Thread Type	Standard	Thread	Part Number	L (L1 + Thread)		D1		HEX1	
						mm	inch	mm	inch	mm	inch
6.3	1/4"	F BSP (Metal Sealing)	ISO 1179-1	BSP 1/4 FEMALE (METAL SEALING)	UHP100 14GMS F	62.3	2.45	28	1.1	24	0.94
6.3	1/4"	F NPTF	ANSI B1.20.3	NPTF 1/4" FEMALE	UHP100 14NPT F	59.3	2.33	28	1.1	24	0.94

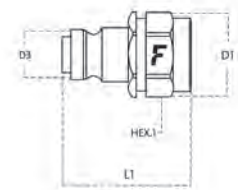

Size		Thread details			MALE								
mm	inch	Thread Type	Standard	Thread	Part Number	L (L1 + Thread)		D1		D3		HEX1	
						mm	inch	mm	inch	mm	inch	mm	inch
6.3	1/4"	F BSP (Metal Sealing)	ISO 1179-1	BSP 1/4 FEMALE (METAL SEALING)	UHP100 14GMS M	39	1.54	25	0.98	14.8	0.58	22	0.87
6.3	1/4"	F NPTF	ANSI B1.20.3	NPTF 1/4" FEMALE	UHP100 14NPT M	38.3	1.51	25	0.98	14.8	0.58	22	0.87

NOTE: Red PVC dust protection are supplied together with the product as a standard.

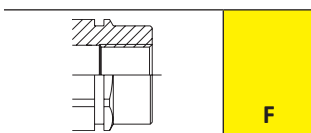



UHP 150

Couplings for Ultra High Pressure applications (150 MPa series).

UHP couplings are the most advanced Faster solution for hydraulic applications with ultra high working pressures of 150 MPa and more. Very robust and reliable, they are characterized by redundant visual and mechanical safety systems.



Applications



Pressure Drop

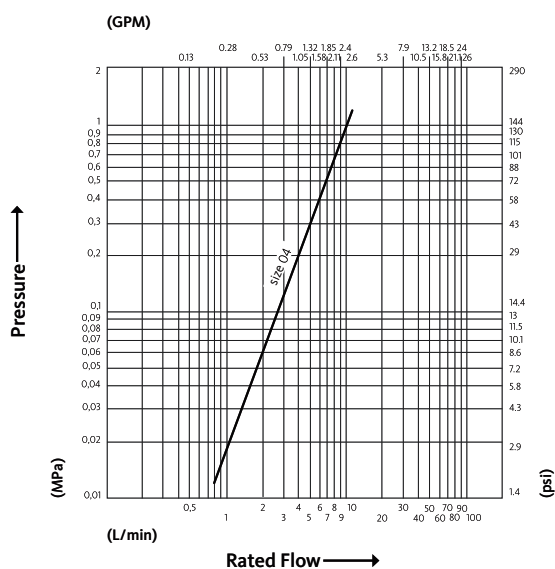

Technical Specifications

dash	Size		Working Pressure (MPa)	Flow Rate (l/min)	Spillage (ml)	Force to Connect (N)	Burst pressure (MPa)		
	mm	inch					Male	Female	Male + Female
04	6.3	1/4"	150	4	0.008	50	350	350	350

Material	Steel
Seals	NBR
Working temperatures	- 25 °C to + 100 °C
Surface treatment	MATE 500 - 1000 (Zn-Ni)
Series Interchange	MARKET

Valve Type	Poppet
Connection	Sleeve Retraction
Disconnection	Sleeve Retraction
Connection Under Pressure	Not Allowed



UHP 150

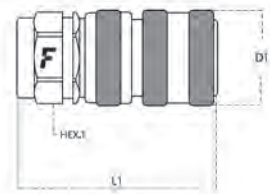

Size		Thread details			FEMALE							
mm	inch	Thread Type	Standard	Thread	Part Number	L (L1 + Thread)		D1		HEX1		
						mm	inch	mm	inch	mm	inch	
6.3	1/4"	F BSP (Metal Sealing)	ISO 1179-1	BSP 1/4 FEMALE (METAL SEALING)	UHP150 14GMS F	62.3	2.45	28	1.1	24	0.94	
6.3	1/4"	F NPTF	ANSI B1.20.3	NPTF 1/4" FEMALE	UHP150 14NPT F	59.3	2.33	28	1.1	24	0.94	

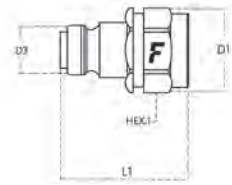

Size		Thread details			MALE								
mm	inch	Thread Type	Standard	Thread	Part Number	L (L1 + Thread)		D1		D3		HEX1	
						mm	inch	mm	inch	mm	inch	mm	inch
6.3	1/4"	F BSP (Metal Sealing)	ISO 1179-1	BSP 1/4 FEMALE (METAL SEALING)	UHP150 14GMS M	39	1.54	25	0.98	14.8	0.58	22	0.87
6.3	1/4"	F NPTF	ANSI B1.20.3	NPTF 1/4" FEMALE	UHP150 14NPT M	38.3	1.51	25	0.98	14.8	0.58	22	0.87

NOTE: Black PVC dust protection are supplied together with the product as a standard.

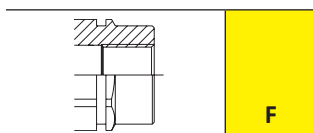

BOP

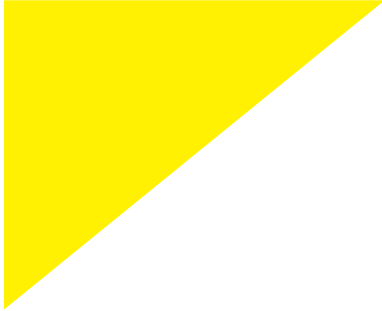

Thanks to specific components and seals, these couplings are API certified and suitable for BOP application.

HNVFR	page 219
FHVFR	page 221
OGVFR	page 223
Couplings Accessories	page 242

HNVFR



Male and Female couplings with poppet valve shut-off system, Lloyd's certified, suitable for Oil & Gas applications.

Thanks to special components and seals, HNVFR couplings are API 16 D certified and suitable for BOP application. Interchangeable according to ISO 7241 Part B.



Applications



Pressure Drop

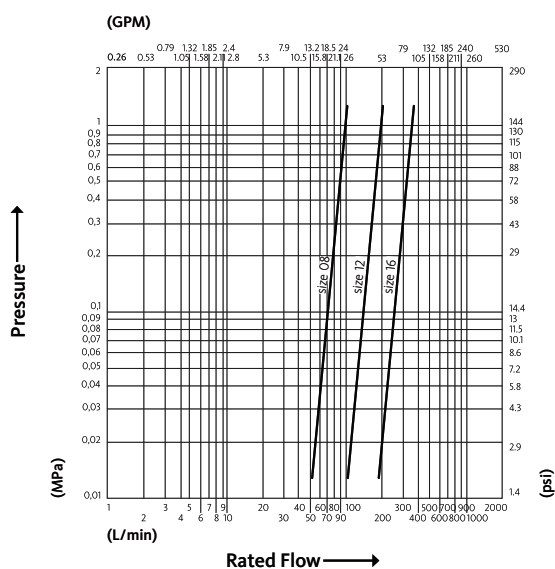

Technical Specifications

dash	Size mm	inch	Working Pressure (MPa)	Flow Rate (l/min)	Spillage (ml)	Force to Connect (N)	Burst pressure (MPa)		
							Male	Female	Male + Female
08	12.5	1/2"	21	60	2.8	130	140	120	150
12	20	3/4"	21	110	10	200	110	100	110
16	25	1"	23	200	13	160	120	120	120

Material	Steel
Seals	SPECIAL
Working temperatures	BOP
Surface treatment	MATE 500 (CrIII); Paint
Series Interchange	ISO 7241 part B

Valve Type	Poppet
Connection	Sleeve Retraction
Disconnection	Sleeve Retraction
Connection Under Pressure	Not Allowed



HNVFR

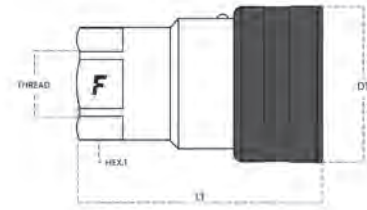

Size		Thread details			FEMALE							
mm	inch	Thread Type	Standard	Thread	Part Number	L (L1 + Thread)		D1		HEX1		
						mm	inch	mm	inch	mm	inch	
12.5	1/2"	F NPTF	ANSI B1.20.3	NPTF 1/2" FEMALE	HNVFR 12 NPT F	72	2.83	47.2	1.86	30	1.18	
20	3/4"	F NPTF	ANSI B1.20.3	NPTF 3/4" FEMALE	HNVFR 34 NPT F	89	3.5	56.2	2.21	36	1.42	
25	1"	F NPTF	ANSI B1.20.3	NPTF 1" FEMALE	HNVFR 1 NPT F	106.4	4.19	62.2	2.45	41	1.61	

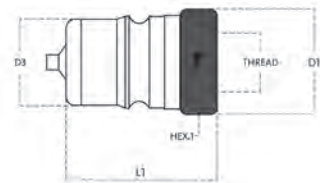

Size		Thread details			MALE									
mm	inch	Thread Type	Standard	Thread	Part Number	L (L1 + Thread)		D1		D3		HEX1		
						mm	inch	mm	inch	mm	inch	mm	inch	
12.5	1/2"	F NPTF	ANSI B1.20.3	NPTF 1/2" FEMALE	HNVFR 12 NPT M	44	1.73	30	1.18	23.5	0.93	27	1.06	
20	3/4"	F NPTF	ANSI B1.20.3	NPTF 3/4" FEMALE	HNVFR 34 NPT M	55	2.17	38	1.5	31.5	1.24	36	1.42	
25	1"	F NPTF	ANSI B1.20.3	NPTF 1" FEMALE	HNVFR 1 NPT M	66	2.6	45	1.77	37.8	1.49	41	1.61	

HNVFR Accessories and Spares



PVC dust protections

page 243

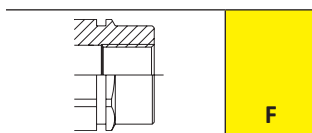

FHVFR



Screw to Connect Flat Face couplings, Lloyd's certified, suitable for Oil & Gas applications.

Equipped with a safety sleeve to help preventing accidental disconnections due to vibrations. Zinc-Nickel plating. Thanks to special components and seals, FHVFR couplings are API 16 D certified and suitable for BOP applications. Faster proprietary profile.



Applications



Pressure Drop

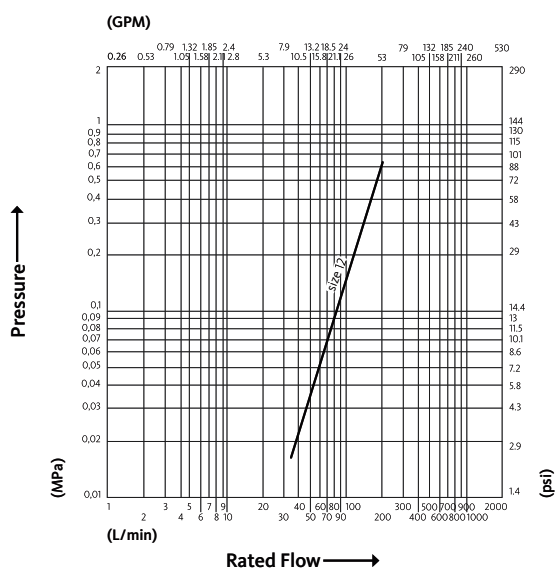

Technical Specifications

dash	Size		Working Pressure (MPa)	Flow Rate (l/min)	Spillage (ml)	Force to Connect (N)	Burst pressure (MPa)		
	mm	inch					Male	Female	Male + Female
12	20	3/4"	35	120	0.02	0	140	140	140

Material	Steel
Seals	SPECIAL
Working temperatures	BOP
Surface treatment	MATE 1000 (ZnNi)
Series Interchange	FASTER

Valve Type	Flat
Connection	Screw to Connect
Disconnection	Unscrew to Disconnect
Connection Under Pressure	Allowed Male Half up to W.P.



FHVFR

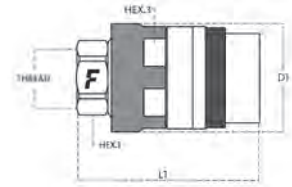

Size		Thread details			FEMALE						
mm	inch	Thread Type	Standard	Thread	Part Number	L (L1 + Thread)		D1		HEX1	
						mm	inch	mm	inch	mm	inch
20	3/4"	F NPTF	ANSI B1.20.3	NPTF 3/4" FEMALE	FHVFR12 34NPT F	129.5	5.1	64	2.52	46	1.81

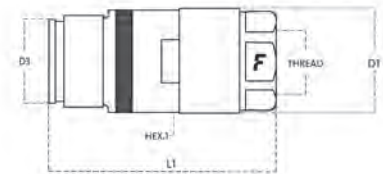

Size		Thread details			MALE								
mm	inch	Thread Type	Standard	Thread	Part Number	L (L1 + Thread)		D1		D3		HEX1	
						mm	inch	mm	inch	mm	inch	mm	inch
20	3/4"	F NPTF	ANSI B1.20.3	NPTF 3/4" FEMALE	FHVFR12 34NPT M	122.5	4.82	54.5	2.15	35	1.38	46	1.81

FHVFR Accessories and Spares



PVC dust protections

page 243



Aluminium dust protections

page 252

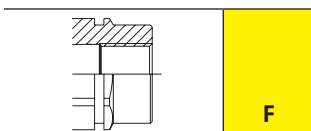



OGVFR

Screw to Connect couplings, Lloyd's certified, suitable for Oil & Gas applications.

Robust sleeve design, poppet valve and ACME connection thread. Thanks to special components and seals, OGVFR couplings are API 16 D certified and suitable for BOP applications.



Applications



Pressure Drop

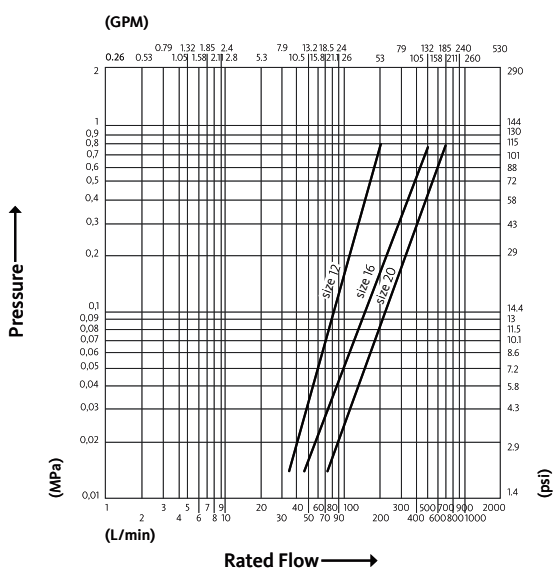

Technical Specifications

dash	Size mm	inch	Working Pressure (MPa)	Flow Rate (l/min)	Spillage (ml)	Force to Connect (N)	Burst pressure (MPa)		
							Male	Female	Male + Female
12	20	3/4"	34.5	120	8	0	168	160	165
16	25	1"	34.5	230	18	0	165	165	172
20	31.5	1-1/4"	34.5	320	21	0	180	200	178

Material	Steel
Seals	SPECIAL
Working temperatures	BOP
Surface treatment	MATE 500 (CrIII); Paint
Series Interchange	MARKET

Valve Type	Poppet
Connection	Screw to Connect
Disconnection	Unscrew to Disconnect
Connection Under Pressure	Allowed Residual



OGVFR

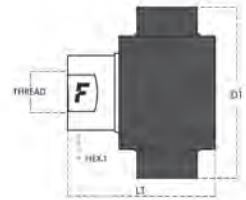

Size		Thread details			FEMALE						
mm	inch	Thread Type	Standard	Thread	Part Number	L (L1 + Thread)		D1		HEX1	
						mm	inch	mm	inch	mm	inch
20	3/4"	F NPSF	ANSI B1.20.3	NPSF 3/4 FEMALE	OGVFR12 34NPS F	72.2	2.84	65	2.56	32	1.26
25	1"	F NPSF	ANSI B1.20.3	NPSF 1 FEMALE	OGVFR16 1NPS F	87.6	3.45	105.5	4.15	41	1.61
31.5	1-1/4"	F NPTF	ANSI B1.20.3	NPTF 1-1/4" FEMALE	OGVFR20 114NPTF	111.9	4.41	118.2	4.65	50	1.97

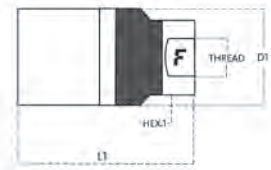

Size		Thread details			MALE								
mm	inch	Thread Type	Standard	Thread	Part Number	L (L1 + Thread)		D1		D3		HEX1	
						mm	inch	mm	inch	mm	inch	mm	inch
20	3/4"	F NPSF	ANSI B1.20.3	NPSF 3/4 FEMALE	OGVFR12 34NPS M	83.1	3.27	44.4	1.74			32	1.26
25	1"	F NPSF	ANSI B1.20.3	NPSF 1 FEMALE	OGVFR16 1NPS M	106	4.17	57.1	2.25			41	1.61
31.5	1-1/4"	F NPTF	ANSI B1.20.3	NPTF 1-1/4" FEMALE	OGVFR20 114NPTM	136.5	5.37	66.4	2.62			50	1.97

OGVFR Accessories and Spares



Aluminium dust protections

page 252

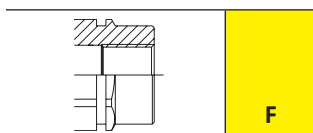

Refrigeration

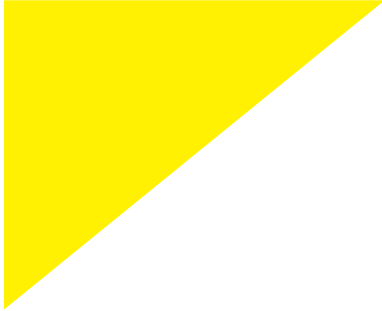

Couplings specifically designed for air conditioning and refrigeration systems.

RF	page 227
RFCS	page 231
RFL	page 235
RFLS-RFS	page 237
Couplings Accessories	page 242



RF

Screw to connect couplings for air conditioning & refrigeration application.

This range of couplings has been specifically designed for air conditioning and refrigeration systems. Interchangeability according to market driven standards. Couplers in steel material, available in both versions with or without adaptor. Wide range of loose supplied adaptors available.



Applications



Technical Specifications

dash	Size		Working Pressure (MPa)	Flow Rate* (g/s)	Air inclusion and fluid loss (cc max)	Maximum leakage rate** (g/year)	Burst pressure (MPa)		
	mm	inch					Male	Female	Male + Female
04	6.3	1/4"	33	20	0.02	1	53	10.5	100
06	10	3/8"	23.3	44	0.05	1	34	19	70
08	12.5	1/2"	18.3	107	0.1	1	55	15	55
12	20	3/4"	14.3	288	0.1	1	43	15	43
16	25	1"	12.3	477	0.2	1	12	15	37

* Flow rate calculated considering air in standard conditions (20°C, 1 bar). For other gases refer to density table on page 241.

** R22 equivalent refrigerant, at operating range, both connected and disconnected.

Material	Steel
Seals	CR (Neoprene)
Working temperatures	- 40 °C to + 120 °C
Surface treatment	MATE 500 (CrIII)
Series Interchange	MARKET

Valve Type	Flat
Connection	Screw to Connect
Disconnection	Unscrew to Disconnect
Connection Under Pressure	Allowed Residual



RF

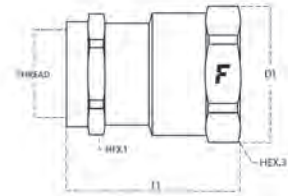

Size		Thread details			FEMALE								
mm	inch	Thread Type	Standard	Thread	Part Number	L (L1 + Thread)		D1		Hex1		Hex3	
						mm	inch	mm	inch	mm	inch	mm	inch
6.3	1/4"	O/ SAE	ASME B1.1	1/2" -20 UNF FEMALE ORB	RF 04 F N	28.7	1.13	21.0	0.83	16.0	0.63	19.0	0.75
10	3/8"	O/ METRIC	ISO 6149-1	M18x1.5 FEMALE ORB	RF 06 F N	34.9	1.37	27.0	1.06	22.0	0.87	24.0	0.94
12.5	1/2"	O/ SAE	ASME B1.1	1/2" -20 UNF FEMALE ORB	RF 08 F N	46.5	1.83	34.0	1.34	27.0	1.06	27.0	1.06
20	3/4"	O/ SAE	ASME B1.1	1-1/4" -18 UNEF FEMALE ORB	RF 12 F N	57.0	2.24	45.0	1.77	36.0	1.42	41.0	1.61
25	1"	O/ SAE	ASME B1.1	1-19/32" -20 UNFEMALE ORB	RF 16 F N	62.5	2.46	55.0	2.17	46.0	1.81	50.0	1.97

Go to page 240 to find the adaptor table. Other seals available upon request.

RF - Threaded adaptor

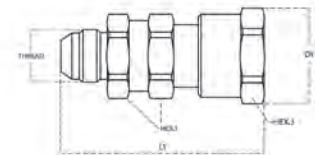

Size		Thread details			FEMALE								
mm	inch	Thread Type	Standard	Thread	Part Number	L (L1 + Thread)		D1		Hex1		Hex3	
						mm	inch	mm	inch	mm	inch	mm	inch
10	3/8"	F NPTF	ANSI B1.20.3	NPTF 3/8" FEMALE	RF06-38NPT F N	51.3	2.02	27.0	1.06	22.0	0.87	24.0	0.94
12.5	1/2"	O/ METRIC	ISO 6149-1	M16x1.5 FEMALE ORB	RF 08 1615 F N	73.6	2.90	34.0	1.34	27.0	1.06	30.0	1.18
20	3/4"	O/ METRIC	ISO 6149-1	M24x1.5 FEMALE ORB	RF 12 2415 F N	82.1	3.23	45.0	1.77	36.0	1.42	41.0	1.61
20	3/4"	F NPTF	ANSI B1.20.3	NPTF 3/4" FEMALE	RF12-34NPT F N	83.6	3.29	45.0	1.77	36.0	1.42	41.0	1.61

Other seals available upon request.



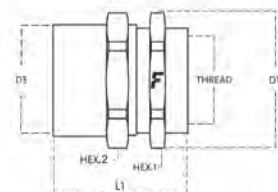

RF

Size		Thread details			MALE									
mm	inch	Thread Type	Standard	Thread	Part Number	L (L1 + Thread)		D1		D3		Hex1		
						mm	inch	mm	inch	mm	inch	mm	inch	
6.3	1/4"	O/SAE	ASME B1.1	1/2" -20 UNF FEMALE ORB	RF 04 M N	27.5	1.08	21.0	0.83	15.8	0.62	19.0	0.75	
10	3/8"	O/METRIC	ISO 6149-1	M18x1.5 FEMALE ORB	RF 06 M N	27.5	1.08	27.0	1.06	20.0	0.79	22.0	0.87	
12.5	1/2"	O/SAE	ASME B1.1	1/2" -20 UNF FEMALE ORB	RF 08 M N	38.5	1.52	34.0	1.34	25.4	1.00	28.0	1.10	
20	3/4"	O/SAE	ASME B1.1	1-1/4" -18 UNEF FEMALE ORB	RF 12 M N	44.0	1.73	46.0	1.81	36.5	1.44	41.0	1.61	
25	1"	O/SAE	ASME B1.1	1-19/32" -20 UNFEMALE ORB	RF 16 M N	46.5	1.83	55.0	2.17	44.5	1.75	48.0	1.89	

Go to page 240 to find the adaptor table. Other seals available upon request.

RF - Threaded adaptor

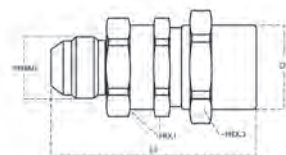

Size		Thread details			MALE									
mm	inch	Thread Type	Standard	Thread	Part Number	L (L1 + Thread)		D1		D3		Hex1		
						mm	inch	mm	inch	mm	inch	mm	inch	
10	1/4"	F NPTF	ANSI B1.20.3	NPTF 3/8" FEMALE	RF06-38NPT M N	44.5	1.75	22.0	0.87	15.8	0.62	22.0	0.87	
12.5	3/8"	O/METRIC	ISO 6149-1	M16x1.5 FEMALE ORB	RF 08 1615 M N	63.5	2.50	34.0	1.34	20.0	0.79	27.0	1.06	
20	1/2"	O/METRIC	ISO 6149-1	M24x1.5 FEMALE ORB	RF 12 2415 M N	69.0	2.72	36.5	1.44	36.5	1.44	36.0	1.42	
20	3/4"	F NPTF	ANSI B1.20.3	NPTF 3/4" FEMALE	RF12-34NPT M N	70.5	2.78	46.0	1.81	36.5	1.44	41.0	1.61	

Other seals available upon request.

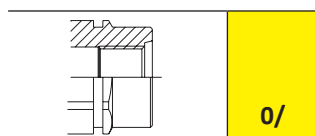
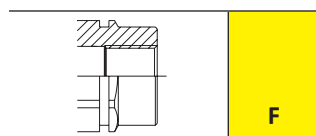

RF Accessories and Spares

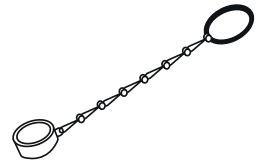
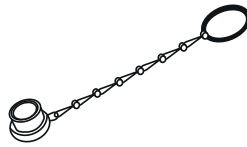

Aluminium dust protections

page 252

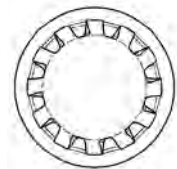

Lock washer for bulkhead mounting

page 259

RFCS



Screw to connect couplings for air conditioning & refrigeration application.

This range of couplings has been specifically designed for air conditioning and refrigeration systems. Interchangeability according to market driven standards. Couplers in brass material with copper sweat braze adaptor.



Applications



Technical Specifications

dash	Size		Working Pressure (MPa)	Flow Rate* (g/s)	Air inclusion and fluid loss (cc max)	Maximum leakage rate** (g/year)	Burst pressure (MPa)		
	mm	inch					Male	Female	Male + Female
06	10	3/8"	6	44	0.05	1	21	19	26
08	12.5	1/2"	5	107	0.1	1	26	15	25
12	20	3/4"	5	288	0.1	1	21	15	19
16	25	1"	5	477	0.2	1	13	15	15

* Flow rate calculated considering air in standard conditions (20°C, 1 bar). For other gases refer to density table on page 241.

** R22 equivalent refrigerant, at operating range, both connected and disconnected.

Material	Brass Copper
Seals	CR (Neoprene)
Working temperatures	- 40 °C to + 120 °C
Surface treatment	
Series Interchange	MARKET

Valve Type	Flat
Connection	Screw to Connect
Disconnection	Unscrew to Disconnect
Connection Under Pressure	Allowed Residual



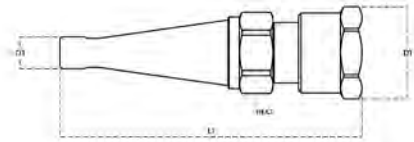

RFCS - Copper sweat

Size		Adaptor Details	FEMALE									
mm	inch		Part Number	L (L1 + Thread)		D1		D3		Hex1		
		Adaptor Type		mm	inch	mm	inch	mm	inch	mm	inch	
10	3/8"	COPPER SWEAT	RF 06 CS065 F5N	67.5	2.66	25.0	0.98	6.5	0.26	22.0	0.87	
10	3/8"	COPPER SWEAT	RF 06 CS095 F5N	76.0	2.99	27.0	1.06	9.7	0.38	22.0	0.87	
12.5	1/2"	COPPER SWEAT	RF 08 CS095 F5N	111.0	4.37	34.0	1.34	9.7	0.38	27.0	1.06	
12.5	1/2"	COPPER SWEAT	RF 08 CS125 F5N	107.0	4.21	34.0	1.34	12.8	0.50	27.0	1.06	
12.5	1/2"	COPPER SWEAT	RF 08 CS160 F5N	107.0	4.21	34.0	1.34	16.1	0.63	27.0	1.06	
20	3/4"	COPPER SWEAT	RF 12 CS160 F5N	131.0	5.16	45.0	1.77	16.1	0.63	36.0	1.42	
20	3/4"	COPPER SWEAT	RF 12 CS190 F5N	131.0	5.16	45.0	1.77	19.2	0.76	36.0	1.42	
20	3/4"	COPPER SWEAT	RF 12 CS220 F5N	131.0	5.16	45.0	1.77	22.4	0.88	36.0	1.42	
25	1"	COPPER SWEAT	RF 16 CS220 F5N	130.8	5.15	53.0	2.09	22.4	0.88	48.0	1.89	
25	1"	COPPER SWEAT	RF 16 CS255 F5N	146.5	5.77	55.0	2.17	25.6	1.01	46.0	1.81	
25	1"	COPPER SWEAT	RF 16 CS290 F5N	146.5	5.77	55.0	2.17	28.7	1.13	50.0	1.97	

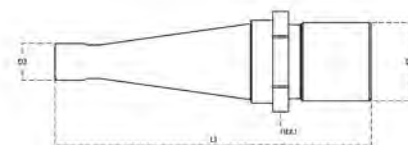

RFCS - Copper sweat

Size		Adaptor details	MALE									
mm	inch		Part Number	L (L1 + Thread)		D1		D3		Hex1		
				mm	inch	mm	inch	mm	inch	mm	inch	
10	3/8"	COPPER SWEAT	RF 06 CS065 M5N	67.5	2.66	25.0	0.98	6.5	0.26	22.0	0.87	
10	3/8"	COPPER SWEAT	RF 06 CS095 M5N	100.0	3.94	32.0	1.26	9.7	0.38	28.0	1.10	
12.5	1/2"	COPPER SWEAT	RF 08 CS095 M5N	100.0	3.94	32.0	1.26	9.7	0.38	28.0	1.10	
12.5	1/2"	COPPER SWEAT	RF 08 CS125 M5N	96.0	3.78	32.0	1.26	12.8	0.50	28.0	1.10	
12.5	1/2"	COPPER SWEAT	RF 08 CS160 M5N	94.0	3.70	32.0	1.26	16.1	0.63	28.0	1.10	
20	3/4"	COPPER SWEAT	RF 12 CS160 M5N	118.5	4.67	46.0	1.81	16.1	0.63	41.0	1.61	
20	3/4"	COPPER SWEAT	RF 12 CS190 M5N	118.5	4.67	46.0	1.81	19.2	0.76	41.0	1.61	
20	3/4"	COPPER SWEAT	RF 12 CS220 M5N	130.8	5.15	53.0	2.09	22.4	0.88	48.0	1.89	
25	1"	COPPER SWEAT	RF 16 CS220 M5N	130.8	5.15	53.0	2.09	22.4	0.88	48.0	1.89	
25	1"	COPPER SWEAT	RF 16 CS255 M5N	130.8	5.15	53.0	2.09	25.6	1.01	48.0	1.89	
25	1"	COPPER SWEAT	RF 16 CS290 M5N	130.8	5.15	53.0	2.09	28.7	1.13	48.0	1.89	

RFCS Accessories and Spares

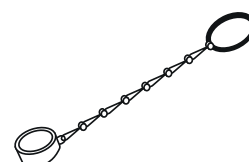
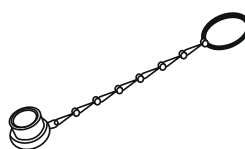

Aluminium dust protections

page 252

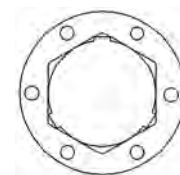

Mounting flanges

page 259



RFL

Screw to connect female couplings for air conditioning & refrigeration application, low friction sleeve.

RFL screw to connect female couplings are equipped with a low friction sleeve in order to reduce connection effort and friction. Fully interchangeable with RF series same size.

Applications



Technical Specifications

dash	Size		Working Pressure (MPa)	Flow Rate* (g/s)	Air inclusion and fluid loss (cc max)	Maximum leakage rate** (g/year)	Burst pressure (MPa)		
	mm	inch					Male	Female	Male + Female
04	6.3	1/4"	3.5	20	0.02	1		10.5	100
06	10	3/8"	6	44	0.05	1		19	70
08	12.5	1/2"	5	107	0.1	1		15	55
12	20	3/4"	5	288	0.1	1		15	43
16	25	1"	5	477	0.2	1		15	37

* Flow rate calculated considering air in standard conditions (20°C, 1 bar). For other gases refer to density table on page 241.

** R22 equivalent refrigerant, at operating range, both connected and disconnected.

Material	Steel
Seals	CR (Neoprene)
Working temperatures	- 40 °C to + 120 °C
Surface treatment	MATE 500 (CrIII)
Series Interchange	RF male Faster

Valve Type	Flat
Connection	Screw to Connect
Disconnection	Unscrew to Disconnect
Connection Under Pressure	Allowed Residual



RFL

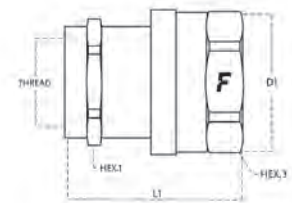

Size		Thread details			FEMALE						
mm	inc	Thread Type	Standard	Thread	Part Number	L (L1 + Thread)		D1		HEX1	
						mm	inch	mm	inch	mm	inch
6.3	1/4"	0/ SAE	ASME B1.1	1/2" -20 UNF FEMALE ORB	RFL04 F N	29.4	1.16	25	0.98	16	0.63
10	3/8"	0/ METRIC	ISO 6149-1	M18x1.5 FEMALE ORB	RFL06 F N	34.5	1.36	28	1.1	22	0.87
12.5	1/2"	0/ SAE	ASME B1.1	7/8" -20 UNEF FEMALE ORB	RFL08 F N	49.3	1.94	34	1.34	27	1.06
20	3/4"	0/ SAE	ASME B1.1	1-1/4" -18 UNEF FEMALE ORB	RFL12 F N	56.8	2.24	45	1.77	36	1.42
25	1"	0/ SAE	ASME B1.1	1-19/32" -20 UN FEMALE ORB	RFL16 F N	64	2.52	55	2.17	46	1.81

Go to page 240 to find the adaptor table.

RFL Accessories and Spares

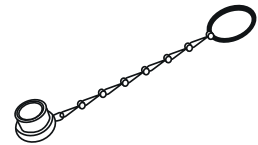

Aluminium dust protections

page 252

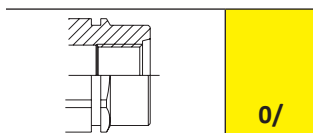



RFLS - RFS

Couplings for air conditioning & refrigeration applications, integrated safety sleeve.

RFLS screw to connect female couplings are equipped with a low friction sleeve to reduce connection effort together with an integrated safety sleeve to prevent accidental disconnections. Corresponding male couplings RFS series are characterized by Faster profile interchangeability.



Applications



Technical Specifications

dash	Size		Working Pressure (MPa)	Flow Rate* (g/s)	Air inclusion and fluid loss (cc max)	Maximum leakage rate** (g/year)	Burst pressure (MPa)		
	mm	inch					Male	Female	Male + Female
04	6.3	1/4"	3.5	20	0.02	1	53	10.5	100
06	10	3/8"	6	44	0.05	1	24	19	70
08	12.5	1/2"	5	107	0.1	1	55	15	55
12	20	3/4"	7	288	0.1	1	55	21	19

* Flow rate calculated considering air in standard conditions (20°C, 1 bar). For other gases refer to density table on page 241.

** R22 equivalent refrigerant, at operating range, both connected and disconnected.

Material	Steel
Seals	CR (Neoprene)
Working temperatures	- 40 °C to + 120 °C
Surface treatment	MATE 500 (CrIII)
Series Interchange	FASTER

Valve Type	Flat
Connection	Screw to Connect
Disconnection	Unscrew to Disconnect
Connection Under Pressure	Allowed Residual



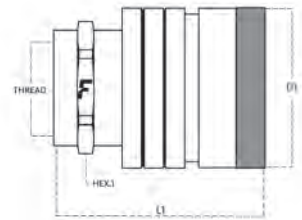

RFLS - RFS

Size		Thread details			FEMALE						
mm	inch	Thread Type	Standard	Thread	Part Number	L (L1 + Thread)		D1		HEX1	
						mm	inch	mm	inch	mm	inch
6.3	1/4"	O/ SAE	ASME B1.1	1/2" -20 UNF FEMALE ORB	RFLS 04 F N	38	1.5	25	0.98	19	0.75
10	3/8"	O/ METRIC	ISO 6149-1	M18x1.5 FEMALE ORB	RFLS 06 F N	43.9	1.73	30	1.18	22	0.87
12.5	1/2"	O/ SAE	ASME B1.1	7/8" -20 UNEF FEMALE ORB	RFLS 08 F N	55.5	2.19	37	1.46	27	1.06
20	3/4"	O/ SAE	ASME B1.1	1-1/4" -18 UNEF FEMALE ORB	RFLS 12 F N	63.6	2.5	48	1.89	36	1.42

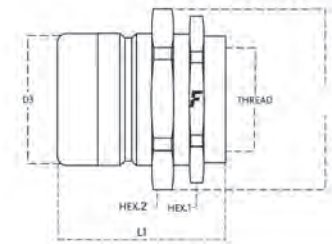

Size		Thread details			MALE								
mm	inch	Thread Type	Standard	Thread	Part Number	L (L1 + Thread)		D1		D3		HEX1	
						mm	inch	mm	inch	mm	inch	mm	inch
6.3	1/4"	O/ SAE	ASME B1.1	1/2" -20 UNF FEMALE ORB	RFS 04 M N	29	1.14	21	0.83	16	0.63	19	0.75
10	3/8"	O/ METRIC	ISO 6149-1	M18x1.5 FEMALE ORB	RFS 06 M N	31.6	1.24	25	0.98	20	0.79	22	0.87
12.5	1/2"	O/ SAE	ASME B1.1	7/8" -20 UNEF FEMALE ORB	RFS 08 M N	41.5	1.63	38	1.5	26	1.02	34	1.34
20	3/4"	O/ SAE	ASME B1.1	1-1/4" -18 UNEF FEMALE ORB	RFS 12 M N	46.6	1.83	50	1.97	36	1.42	46	1.81

RFLS - RFS Accessories and Spares



Aluminium dust protections

page 252

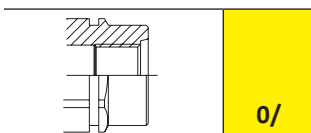

Refrigeration - Adaptor

Braze Tubing Adaptor

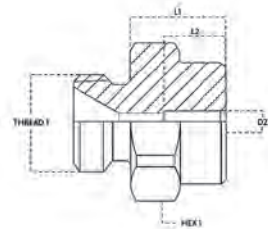

Size			Thread details			Braze Tubing Adaptor								
dash	mm	inch	Part Number	Material	Thread1	HEX1		L1		L2		D2		Tight. Torque Nm
						mm	inch	mm	inch	mm	inch	mm	inch	
04	6.3	1/4	RF 04 TS065	Brass	1/2" - 20 UNF	19	0.75	12.4	0.49	8	0.31	6.5	0.26	20 ⁺⁵ ₋₀
04	6.3	1/4	RF 04 TS095	Brass	1/2" - 20 UNF	19	0.75	12.4	0.49	8	0.31	9.7	0.38	20 ⁺⁵ ₋₀
06	10	3/8	RF 06 TS095	Brass	M18x1.5	21	0.83	13	0.51	8	0.31	9.7	0.38	25 ⁺⁵ ₋₀
06	10	3/8	RF 06 TS125	Brass	M18x1.5	21	0.83	13	0.51	12	0.47	12.8	0.50	25 ⁺⁵ ₋₀
08	12.5	1/2	RF 08 TS065	Brass	7/8" - 20 UNEF	27	1.06	13	0.51	8	0.31	6.5	0.26	40 ⁺⁵ ₋₀
08	12.5	1/2	RF 08 TS095	Brass	7/8" - 20 UNEF	27	1.06	13	0.51	10	0.39	9.7	0.38	40 ⁺⁵ ₋₀
08	12.5	1/2	RF 08 TS125	Brass	7/8" - 20 UNEF	27	1.06	13	0.51	13	0.51	12.8	0.50	40 ⁺⁵ ₋₀
08	12.5	1/2	RF 08 TS160	Brass	7/8" - 20 UNEF	27	1.06	13	0.51	14	0.55	16.1	0.63	40 ⁺⁵ ₋₀
12	20	3/4	RF 12 TS125	Brass	1-1/4" - 18 UNEF	36	1.42	17.5	0.69	13	0.51	12.8	0.50	70 ⁺⁵ ₋₀
12	20	3/4	RF 12 TS160	Brass	1-1/4" - 18 UNEF	36	1.42	17.5	0.69	14	0.55	16.1	0.63	70 ⁺⁵ ₋₀
12	20	3/4	RF 12 TS190	Brass	1-1/4" - 18 UNEF	6	0.24	17.5	0.69	17	0.67	19.2	0.76	70 ⁺⁵ ₋₀
12	20	3/4	RF 12 TS220	Brass	1-1/4" - 18 UNEF	6	0.24	17.5	0.69	20	0.79	22.4	0.88	70 ⁺⁵ ₋₀
16	25	1	RF 16 TS220	Brass	1-19/32" - 18 UN	46	1.81	38	1.50	20	0.79	22.4	0.88	90 ⁺¹⁰ ₋₀
16	25	1	RF 16 TS255	Brass	1-19/32" - 18 UN	46	1.81	38	1.50	20	0.79	25.6	1.01	90 ⁺¹⁰ ₋₀
16	25	1	RF 16 TS290	Brass	1-19/32" - 18 UN	46	1.81	38	1.50	25	0.98	28.7	1.13	90 ⁺¹⁰ ₋₀

Form Tubing Adaptor

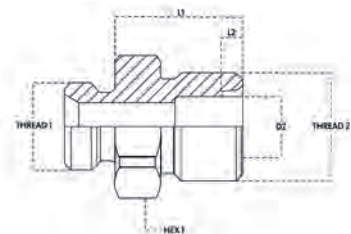

Size			Thread details				Form Tubing Adaptor								
dash	mm	inch	Part Number	Material	Thread1	Thread2	HEX1		L1		L2		D2		Tight. Torque Nm
							mm	inch	mm	inch	mm	inch	mm	inch	
04	6.3	1/4"	RF 04 TD38	Steel	1/2" - 20 UNF	5/8" - 18 UNF	19	0.75	18.9	0.74	3.3	0.13	8.65	0.34	20 ⁺⁵ ₋₀
06	10	3/8"	RF 06 TD38	Steel	M18x1.5	5/8" - 18 UNF	21	0.83	21	0.83	3.3	0.13	8.65	0.34	20 ⁺⁵ ₋₀
08	12.5	1/2"	RF 08 TD12	Steel	7/8" - 20 UNEF	3/4" - 16 UNF	27	1.06	21.5	0.85	3.3	0.13	11.8	0.46	40 ⁺⁵ ₋₀
08	12.5	1/2"	RF 08 TD38	Steel	7/8" - 20 UNEF	5/8" - 18 UNF	27	1.06	19	0.75	3.3	0.13	8.65	0.34	40 ⁺⁵ ₋₀
08	12.5	1/2"	RF 08 TD58	Steel	7/8" - 20 UNEF	7/8" - 14 UNF	27	1.06	25	0.98	3.3	0.13	14.6	0.57	40 ⁺⁵ ₋₀
12	20	3/4"	RF 12 TD58	Steel	1-1/4" - 18 UNEF	7/8" - 14 UNF	36	1.42	28	1.10	3.3	0.13	14.6	0.57	70 ⁺¹⁰ ₋₀

Flow rate calculation

Tests have been carried out according to ANSI/ASHRAE Standard 78-1985 (RA 2003). The diagram shows for each coupling size the pressure drop factor $W\Delta p$ related to mass air flow rate Q .

The graph allows to calculate the pressure drop [kPa] occurring at specified flow rate (g/s) and vice versa, starting from specific weight of the refrigerant gas.

Table below shows specific weights of the most common refrigerant gases in saturated conditions. Data for both liquid and vapour phase are available for different temperatures. Example: You need to calculate a R1234-yf flow rate at 10°C (50°F) in capour status causing a pressure drop of 13,8 kPa through a RF 08 coupling.

Specific gas weight from table is 24,27 kg/m³.

You multiply pressure drop by specific weight to obtain $W\Delta p=334,92 \text{ kgkPa/m}^3$.

From diagram, mass flowrate Q is roughly 40 g/s.

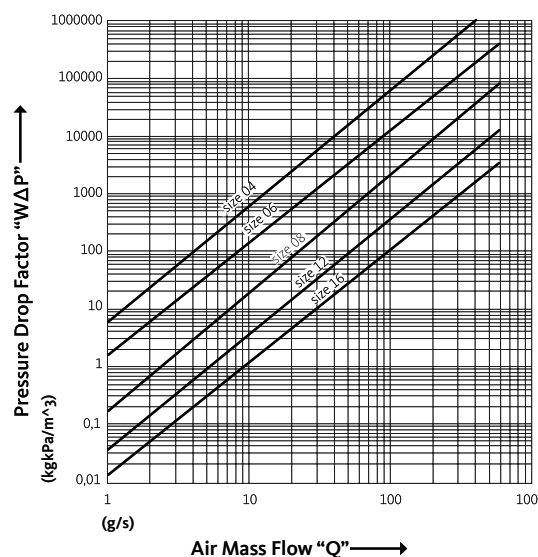

Temperature		R422D		R1234-yf		R407a		R407f		R32		R410a	
°C	°F	Specific Weight kg/m ³		Specific Weight kg/m ³		Specific Weight kg/m ³		Specific Weight kg/m ³		Specific Weight kg/m ³		Specific Weight kg/m ³	
		L	V	L	V	L	V	L	V	L	V	L	V
-50	-58	1423	3.37	1318	2.35	1410	10.95	1385	2.68	1208	3.23	1340	4.54
-45	-49	1408	4.34	1305	3.25	1398	8.93	1369	3.78	1193	5.31	1324	5.67
-40	-40	1391	5.15	1293	3.08	1387	4.57	1355	3.28	1180	5.07	1308	7.02
-35	-31	1375	6.93	1280	3.34	1371	5.75	1340	3.38	1167	4.88	1292	8.62
-30	-22	1358	8.61	1265	5.86	1355	7.16	1322	6.88	1151	7.64	1276	10.48
-25	-13	1342	10.60	1252	5.16	1338	8.84	1309	5.37	1138	6.74	1258	12.65
-20	-4	1324	12.93	1238	6.72	1321	10.81	1292	7.27	1121	11.16	1241	15.15
-15	5	1306	15.64	1223	8.72	1304	13.11	1275	9.77	1107	10.91	1223	18.04
-10	14	1288	18.79	1207	12.56	1286	15.78	1254	15.11	1089	15.87	1205	21.35
-5	23	1270	22.43	1193	14.02	1268	18.87	1238	16.56	1074	17.38	1186	25.13
0	32	1251	26.61	1177	17.33	1249	22.44	1219	20.86	1055	22.09	1167	29.44
5	41	1231	31.41	1160	21.06	1230	26.53	1199	25.76	1038	26.15	1147	34.34
10	50	1210	36.90	1144	24.27	1210	31.22	1180	29.85	1020	30.23	1126	39.91
15	59	1189	43.18	1126	29.85	1189	36.59	1157	37.35	999	37.22	1105	46.22
20	68	1167	50.36	1108	34.89	1168	42.73	1135	44.05	981	40.86	1082	53.38
25	77	1143	58.58	1090	40.37	1145	49.74	1113	51.35	958	50.59	1059	61.50
30	86	1119	68.00	1073	43.73	1122	57.78	1094	55.18	940	54.78	1034	70.71
35	95	1093	78.84	1052	52.63	1097	67.00	1066	67.74	914	66.26	1008	81.18
40	104	1065	91.38	1032	59.41	1071	77.62	1042	76.84	893	73.27	980	93.12
45	113	1036	105.98	1012	66.63	1043	89.92	1016	86.54	868	84.23	951	106.79
50	122	1003	123.18	990	75.88	1013	104.29	988	99.48	839	98.55	920	122.55

Couplings accessories

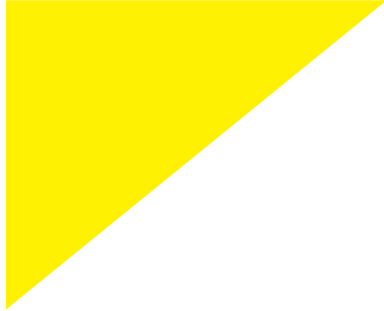

PVC dust protections	page 243
Plastic dust protections	page 249
Acetal Resin dust protections	page 250
Aluminium dust protections	page 252
Stainless steel dust protections	page 258
Lock washer for bulkhead mounting	page 259
Mounting flanges	page 259
FastGrip	page 260
Oil Collecting System	page 261
Seal Kits	page 262

PVC dust protections



Dust protections for female couplings

Size			Details			
dash	mm	inch	Part number	Colour	Available for Series	
02	3.2	1/8"	TMH 18	●	HNH - HNV brass - TNV	
04	6.3	1/4"	TM 14	●	NS - NV	
04	6.3	1/4"	TM 14 A	●		
04	6.3	1/4"	TM 14 G	●		
04	6.3	1/4"	TM 14 GR	●		
04	6.3	1/4"	TM 14 N	●		
04	6.3	1/4"	TM 14 R	●		
04	6.3	1/4"	TM 14 V	●		
04	6.3	1/4"	TMH 14	●		HNH - HNV brass - HNV stainless steel - TNL - TNV
04	6.3	1/4"	TMH 14 N	●		
04	6.3	1/4"	TMA 14	●	ANV	
04	6.3	1/4"	TMA 14 A	●		
04	6.3	1/4"	TMA 14 R	●		
06	10	3/8"	TM 38	●	CFPV - NS - NV	
06	10	3/8"	TM 38 G	●		
06	10	3/8"	TM 38 R	●		
06	10	3/8"	TM 38 V	●		
06	10	3/8"	TMA 38	●	ANV - CPV - TNL - TNV	
06	10	3/8"	TMA 38 A	●		
06	10	3/8"	TMA 38 B	●		
06	10	3/8"	TMA 38 N	●		
06	10	3/8"	TMA 38 R	●		
06	10	3/8"	TMA 38 V	●		
06	10	3/8"	TMH 38	●	HNH - HNV brass - HNV stainless steel	
06	10	3/8"	TMH 38 A	●		
06	10	3/8"	TMH 38 B	●		
06	10	3/8"	TMH 38 G	●		
06	10	3/8"	TMF 38	●	3FFH - FFH - FSH	
06	10	3/8"	TMF 38 B	●		
06	10	3/8"	TMF 38 G	●		
06	10	3/8"	TMF 38 N	●		
06	10	3/8"	TMF 38 R	●		
06	10	3/8"	TMF 38 V	●		
08	12.5	1/2"	TM 12 L	●	NL - NS - NV - SV - 3CNV - 3CPV - 3NV - 4CPV - 4NV - 4PV CFPV - CPV - PS - PV - 3CFHF - 3CKHF - 4SRHF - 4SKHF	
08	12.5	1/2"	TM 12 L/A	●		
08	12.5	1/2"	TM 12 L/G	●		
08	12.5	1/2"	TM 12 L/M	●		
08	12.5	1/2"	TM 12 L/N	●		
08	12.5	1/2"	TM 12 L/R	●		

PVC dust protections



Dust protections for female couplings

Size			Details		
dash	mm	inch	Part number	Colour	Available for Series
08	12.5	1/2"	TM 12 L/V	●	NL - NS - NV - SV - 3CNV - 3CPV - 3NV - 4CPV - 4NV - 4PV CFPV - CPV - PS - PV - 3CFHF - 3CKHF - 4SRHF - 4SKHF
08	12.5	1/2"	TM 12-38	●	NL - NS - NV - SV
08	12.5	1/2"	TMH 12	●	HNVFR - HNV - HNV brass - HNV stainless steel - TNL - TNV
12	20	3/4"	TM 34	●	NL - NV - NS
12	20	3/4"	TMH 34	●	HNVFR - HNV - HNV brass - HNV stainless steel - 4HNV - TNL - TNV
12	20	3/4"	TMH 34 N	●	
12	20	3/4"	TMA 34	●	
12	20	3/4"	TMA 34 N	●	
12	20	3/4"	TMA 34 R	●	ANV
16	25	1"	TM 1	●	NS - NV
16	25	1"	TM 1 R	●	
16	25	1"	TMH 1	●	HNVFR - HNV - HNV brass - HNV stainless steel - TNL brass - TNV
16	25	1"	TMA 1	●	ANV - CPV
16	25	1"	TMA 1 N	●	
16	25	1"	TMA 1 R	●	



Dust protections for female couplings

Size			Details		
dash	mm	inch	Part number	Colour	Available for Series
08	12.5	1/2"	TM 12-38	●	NL - NS - NV - SV - 3CNV - 3CPV - 3NV - 4CPV - 4NV - 4PV CFPV - CPV - PS - PV - 3CFHF - 3CKHF - 4SRHF - 4SKHF
08	12.5	1/2"	TM 12-38 G	●	
08	12.5	1/2"	TM 12-38 GR	●	
08	12.5	1/2"	TM 12-38 M	●	
08	12.5	1/2"	TM 12-38 N	●	
08	12.5	1/2"	TM 12-38 R	●	
08	12.5	1/2"	TM 12-38 V	●	

PVC dust protections

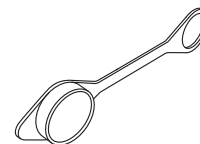

Dust protections for female couplings

Size			Details		
dash	mm	inch	Part number	Colour	Available for Series
04	6.3	1/4"	TM 2FI14	●	2FFI stainless steel - FFH
04	6.3	1/4"	TM 2FI14 N	●	
08	12.5	1/2"	TM 2FI12	●	2FFI brass - 2FFI stainless steel - 3FFH - FFH - FSH
08	12.5	1/2"	TM 2FI12 N	●	
10	16	5/8"	TM 2FI58	●	FFH
12	20	3/4"	TM 2FI34	●	2FFI stainless steel - 3FFH - FFH - FSH
12	20	3/4"	TM 2FI34 N	●	
12	20	3/4"	TM 2FI34 R	●	2FFI stainless steel - 3FFH - FFH - FSH
16	25	1"	TM 2FI1	●	2FFI stainless steel - FFH - FSH
16	25	1"	TM 2FI1 N	●	

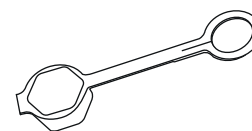

Dust protections for female couplings

Size			Details		
dash	mm	inch	Part number	Colour	Available for Series
06	10	3/8"	TMV 38	●	VV - VVM

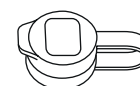

Dust protections for female couplings

Size			Details		
dash	mm	inch	Part number	Colour	Available for Series
04	6.3	1/4"	TM FPI04	●	FPI
06	10	3/8"	TM FPI06	●	
08	12.5	1/2"	TM 5FPI08 R	●	5FPI
10	16	5/8"	TM 5FPI10 N	●	

PVC dust protections



Dust protections for male couplings

Size			Details		
dash	mm	inch	Part number	Colour	Available for Series
02	3.2	1/8"	TFH 18	●	HNV - HNV brass
04	6.3	1/4"	TFA 14	●	ANV - TNL
04	6.3	1/4"	TFA 14 V	●	
04	6.3	1/4"	TF 14	●	NS - NV
04	6.3	1/4"	TF 14 G	●	
04	6.3	1/4"	TF 14 N	●	
04	6.3	1/4"	TF 14 R	●	
04	6.3	1/4"	TF 14 V	●	
04	6.3	1/4"	TFH 14	●	
04	6.3	1/4"	TFH 14 N	●	HNV - HNV brass - HNV stainless steel - TNV
06	10	3/8"	TFF 38	●	2FFI stainless steel - 3FFH - FFH
06	10	3/8"	TFF 38 B	●	
06	10	3/8"	TFF 38 G	●	
06	10	3/8"	TFF 38 N	●	
06	10	3/8"	TFF 38 R	●	
06	10	3/8"	TFF 38 V	●	
06	10	3/8"	TFA 38	●	ANV - CNV - TNL - TNV
06	10	3/8"	TFA 38 A	●	
06	10	3/8"	TFA 38 B	●	
06	10	3/8"	TFA 38 N	●	
06	10	3/8"	TFA 38 R	●	
06	10	3/8"	TFA 38 V	●	
06	10	3/8"	TF 38	●	NS - NV
06	10	3/8"	TF 38 R	●	HNV - HNV brass - HNV stainless steel - TNL - TNV
06	10	3/8"	TFH 38	●	
06	10	3/8"	TFH 38 A	●	
06	10	3/8"	TFH 38 B	●	
06	10	3/8"	TFH 38 G	●	
06	10	3/8"	TFH 38 N	●	
08	12.5	1/2"	TF 12	●	2NS - 2NV - 4NV - AGRI - CNV - NL - NS - NV
08	12.5	1/2"	TF 12 A	●	
08	12.5	1/2"	TF 12 G	●	
08	12.5	1/2"	TF 12 GR	●	
08	12.5	1/2"	TF 12 M	●	
08	12.5	1/2"	TF 12 N	●	
08	12.5	1/2"	TF 12 R	●	
08	12.5	1/2"	TF 12 V	●	
08	12.5	1/2"	TFH 12	●	HNV - HNVFR - HNV brass - HNV stainless steel - TNL - TNV
12	20	3/4"	TFA 34	●	ANV - CNV
12	20	3/4"	TFA 34 B	●	
12	20	3/4"	TFA 34 N	●	
12	20	3/4"	TFA 34 R	●	

PVC dust protections



Dust protections for male couplings

Size			Details		
dash	mm	inch	Part number	Colour	Available for Series
12	20	3/4"	TF 34	●	NL - NS - NV
12	20	3/4"	TFH 34	●	HNV - HNVFR - HNV brass - HNV stainless steel - 4HNV - TNL - TNV
12	20	3/4"	TFH 34 N	●	
16	25	1"	TFA 1	●	
16	25	1"	TFA 1 N	●	ANV - CNV
16	25	1"	TFA 1 R	●	NS - NV
16	25	1"	TF 1	●	
16	25	1"	TFH 1	●	
					HNV - HNV brass - HNV stainless steel - HNVFR - TNL brass

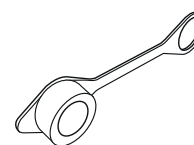

Dust protections for male couplings

Size			Details		
dash	mm	inch	Part number	Colour	Available for Series
04	6.3	1/4"	TF 2FI14	●	2FFI stainless steel - FFH
04	6.3	1/4"	TF 2FI14 N	●	
08	12.5	1/2"	TF 2FI12	●	2FFI brass - 2FFI stainless steel - 3FFH - FFH
08	12.5	1/2"	TF 2FI12 B	●	2FFI stainless steel - 3FFH - FFH
08	12.5	1/2"	TF 2FI12 N	●	2FFI brass - 2FFI stainless steel - 3FFH - FFH
08	12.5	1/2"	TF 2FI12 R	●	2FFI stainless steel - 3FFH - FFH
10	16	5/8"	TF 2FI58	●	3FFH - FFH
12	20	3/4"	TF 2FI34	●	2FFI stainless steel - 3FFH - FFH
12	20	3/4"	TF 2FI34 N	●	
12	20	3/4"	TF 2FI34 R	●	
16	25	1"	TF 2FI1	●	2FFI stainless steel - FFH
16	25	1"	TF 2FI1 N	●	

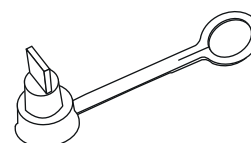

Dust protections for male couplings

Size			Details		
dash	mm	inch	Part number	Colour	Available for Series
06	10	3/8"	TFV 38	●	VV - VVM

PVC dust protections

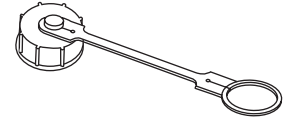

Dust protections for male couplings

Size			Details		
dash	mm	inch	Part number	Colour	Available for Series
06	10	3/8"	TFVA	●	VA
06	10	3/8"	TFVA N	●	

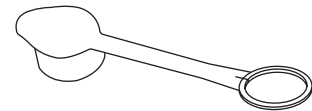

Dust protections for male couplings

Size			Details		
dash	mm	inch	Part number	Colour	Available for Series
06	10	3/8"	TFVF	●	VF
06	10	3/8"	TFVF B	●	
06	10	3/8"	TFVF G	●	
06	10	3/8"	TFVF N	●	
06	10	3/8"	TFVF R	●	

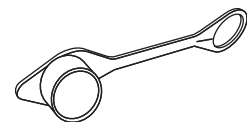

Dust protections for male couplings

Size			Details		
dash	mm	inch	Part number	Colour	Available for Series
04	6.3	1/4"	TFDF 04	●	DF



Dust protections for female/male couplings

Size			Details		
dash	mm	inch	Part number	Colour	Available for Series
06	10	3/8"	TM-TF FHV06	●	FHV
08	12.5	1/2"	TM-TF FHV08	●	
12	20	3/4"	TM-TF FHV12	●	FHV - FHVFR
16	25	1"	TM-TF FHV16	●	
20	31.5	1-1/4"	TM-TF FHV20S	●	FHV
24	37.5	1-1/2"	TM-TF FHV24C	●	
32	50	2"	TM-TF FHV32C	●	

Plastic dust protections

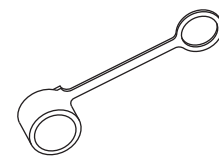

Dust protections for female couplings

Size			Details		
dash	mm	inch	Part number	Colour	Available for Series
04	6.3	1/4"	TMVV 04	●	CVV
06	10	3/8"	TMVV 06	●	
08	12.5	1/2"	TMVV 08	●	
12	20	3/4"	TMVV 12	●	
16	25	1"	TMVV 16	●	
24	37.5	1-1/2"	TMVV 24	●	

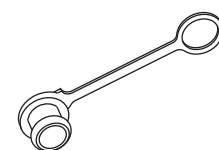

Dust protections for male couplings

Size			Details		
dash	mm	inch	Part number	Colour	Available for Series
04	6.3	1/4"	TFVV 04	●	CVV
06	10	3/8"	TFVV 06	●	
08	12.5	1/2"	TFVV 08	●	
12	20	3/4"	TFVV 12	●	
16	25	1"	TFVV 16	●	CVLS - CVV
24	37.5	1-1/2"	TFVV 24	●	CVV

Acetal Resin dust protections



Dust protections for female couplings

Size			Details		
dash	mm	inch	Part number	Colour	Available for Series
06	10	3/8"	TAF 38	●	3FFH - FFH - FSH
06	10	3/8"	TAF 38 G	●	
06	10	3/8"	TAF 38 M UV	●	
06	10	3/8"	TAF 38 N	●	
06	10	3/8"	TAF 38 R	●	
06	10	3/8"	TAF 38 UV	●	
06	10	3/8"	TAF 38 V	●	
06	10	3/8"	TAF 38 V UV	●	
10	16	5/8"	TAF 58 R UV	●	FFH
10	16	5/8"	TAF 58 UV	●	
12	20	3/4"	TAF 34 R UV	●	
12	20	3/4"	TAF 34 UV	●	



Dust protections for female couplings

Size			Details		
dash	mm	inch	Part number	Colour	Available for Series
08	12.5	1/2"	TAID 12 N	●	FFH - 3CNV - 3CPV - 3NV - CFPV 3CFHF - 3CKHF 4SRHF - 4SKHF

Acetal Resin dust protections



Dust protections for female couplings

Size			Details		
dash	mm	inch	Part number	Colour	Available for Series
08	12.5	1/2"	TA 12	●	FFH - 3CNV - 3CPV - 3NV - CFPV 3CFHF - 3CKHF 4SRHF - 4SKHF 3CNV - 3CPV - 3NV - CFPV 3CFHF - 3CKHF 4SRHF - 4SKHF
08	12.5	1/2"	TA 12 G	●	
08	12.5	1/2"	TA 12 G UV	●	
08	12.5	1/2"	TA 12 GR	●	
08	12.5	1/2"	TA 12 M	●	
08	12.5	1/2"	TA 12 M UV	●	
08	12.5	1/2"	TA 12 N	●	
08	12.5	1/2"	TA 12 N UV	●	
08	12.5	1/2"	TA 12 R	●	
08	12.5	1/2"	TA 12 R UV	●	
08	12.5	1/2"	TA 12 UV	●	
08	12.5	1/2"	TA 12 V	●	
08	12.5	1/2"	TA 12 V UV	●	

Aluminium dust protections



Dust protections for female couplings

Size			Details		
dash	mm	inch	Part number	Colour	Available for Series
02	3.2	1/8"	TMH 18 S	○	HNH - HNV brass
04	6.3	1/4"	TM 14 S	○	NS - NV
04	6.3	1/4"	TMH 14 S	○	HNH - HNV brass - HNV stainless steel - TNL
04	6.3	1/4"	TMV 14 S	○	VVS - VVS stainless steel
04	6.3	1/4"	TMP 14	○	PVVM
04	6.3	1/4"	TMRFLS04 N	○	RFLS/RFS
06	10	3/8"	TMH 38 S	○	HNH
06	10	3/8"	TMP 38	○	VVM
06	10	3/8"	TMV 38 S	○	VV - VVM
06	10	3/8"	TMVM 38 SB	●	
06	10	3/8"	TMVM 38 SG	●	
06	10	3/8"	TMVM 38 SN	●	
06	10	3/8"	TMVM 38 SR	●	
06	10	3/8"	TMP 38	○	PVSM - PVVM
06	10	3/8"	TMRFLS06 N	○	RFLS/RFS
08	12.5	1/2"	TM 12 S	○	NL - NS - NV - SV
08	12.5	1/2"	TMV 12 S	○	VV - VVS - VVS stainless steel
08	12.5	1/2"	TMVM 12 SR	●	
08	12.5	1/2"	TMRFLS08 N	○	RFLS/RFS
08	12.5	1/2"	TM 12 S	○	3CNV - 3CPV - 3NV - 4CPV - 4NV - 4PV - CFPV - CPV PS - PV - 3CFHF - 3CKHF - 4SRHF - 4SKHF
12	20	3/4"	TM 34 S	○	NL - NS - NV
12	20	3/4"	TMV 34 S	○	VV - VVS - VVS stainless steel
12	20	3/4"	TM 34 S	○	CFPV
16	25	1"	TM 1 S	○	NS - NV
16	25	1"	TMV 1 S	○	VV
20	31.5	1-1/4"	TM114 S	○	NV
20	31.5	1-1/4"	TMV114 S	○	VVS - VVS stainless steel
20	31.5	1-1/4"	TMV112 S	○	VVS
24	37.5	1-1/2"	TM112 S	○	NV
24	37.5	1-1/2"	TMH112 S	○	HNH - HNV brass - HNV stainless steel - TNL brass
32	50	2"	TMV 2 S	○	VVS - VVS stainless steel

Aluminium dust protections

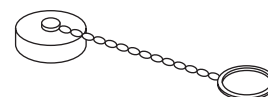

Dust protections for female couplings

Size			Details		
dash	mm	inch	Part number	Colour	Available for Series
04	6.3	1/4"	TM 2FI14 S	○	2FFI stainless steel - FFH
06	10	3/8"	TM 2FN38 S	○	2FFI stainless steel - 3FFH - FFH - FSH
08	12.5	1/2"	TM 2FI12 S	○	2FFI brass - 2FFI stainless steel - 3FFH - FFH - FSH
08	12.5	1/2"	TMCVC 08 S	○	CVC
12	20	3/4"	TM 2FI34 S	○	2FFI stainless steel - 3FFH - FFH - FSH
12	20	3/4"	TMCVE 34 S	○	CVE
16	25	1"	TM 2FI1 S	○	2FFI stainless steel - FFH - FSH
16	25	1"	TMCVC 16 S	○	CVC
16	25	1"	TMCVE 1 S	○	CVE
32	50	2"	TM 2FI2 S	○	2FFI stainless steel

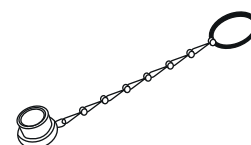

Dust protections for female couplings

Size			Details		
dash	mm	inch	Part number	Colour	Available for Series
04	6.3	1/4"	TMRF 04 S N	○	RF - RFL
06	10	3/8"	TMRF 06 S N	○	RF - RFL - RFCS
08	12.5	1/2"	TMRF 08 S N	○	
12	20	3/4"	TMFB 12 S	○	FB
12	20	3/4"	TMRF 12 S N	○	RF - RFL - RFCS
16	25	1"	TMFB 16 S	○	FB
16	25	1"	TMRF 16 S N	○	RF - RFL - RFCS
20	31.5	1-1/4"	TMFB 20 S	○	FB
24	37.5	1-1/2"	TMFB 24 S	○	

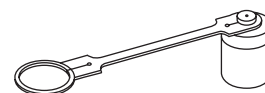

Dust protections for female couplings

Size			Details		
dash	mm	inch	Part number	Colour	Available for Series
04	6.3	1/4"	TMVV 04 S	○	CVV
06	10	3/8"	TMVV 06 S	○	
08	12.5	1/2"	TMVV 08 S	○	
16	25	1"	TMVV 16 S	○	
24	37.5	1-1/2"	TMVV 24 S	○	

Aluminium dust protections



Dust protections for female couplings

Size			Details		
dash	mm	inch	Part number	Colour	Available for Series
12	20	3/4"	TM OGV12 S	○	OGV - OGVFR
16	25	1"	TM OGV16 S	○	
20	31.5	1-1/4"	TM OGV20 S	○	
24	37.5	1-1/2"	TM OGV24 S	○	OGV - OGVST
32	50	2"	TM OGV32 S	○	



Dust protections for female couplings

Size			Details		
dash	mm	inch	Part number	Colour	Available for Series
06	10	3/8"	TM FHV06 S	○	FHV
08	12.5	1/2"	TM FHV08 S	○	
12	20	3/4"	TM FHV12 S	○	FHV - FHVFR
16	25	1"	TM FHV16 S	○	
20	31.5	1-1/4"	TM FHV20 S	○	FHV
24	37.5	1-1/2"	TM FHV24 S	○	
32	50	2"	TM FHV32 S	○	



Dust protections for female couplings

Size			Details		
dash	mm	inch	Part number	Colour	Available for Series
20	31.5	1-1/4"	TM FFH 20 S	○	FFH

Aluminium dust protections

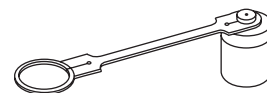

Dust protections for male couplings

Size			Details		
dash	mm	inch	Part number	Colour	Available for Series
02	3.2	1/8"	TFH 18 S	○	HNH - HNV brass
04	6.3	1/4"	TF 14 S	○	NS - NV
04	6.3	1/4"	TFH 14 S	○	HNH - HNV brass - HNV stainless steel
04	6.3	1/4"	TFP 14	○	PVVM - VVS
04	6.3	1/4"	TFV 14 S	○	VVS - VVS stainless steel
04	6.3	1/4"	TFRFS04 N	○	RFLS/RFS
06	10	3/8"	TFP 38	○	PVSM - PVVM - VVM
06	10	3/8"	TFV 38 S	○	VV - VVM
06	10	3/8"	TFVM 38 SB	●	
06	10	3/8"	TFVM 38 SG	●	
06	10	3/8"	TFVM 38 SN	●	
06	10	3/8"	TFVM 38 SR	●	
06	10	3/8"	TFRFS06 N	○	RFLS/RFS
08	12.5	1/2"	TF 12 S	○	NL - NS - NV
08	12.5	1/2"	TFV 12 S	○	VV - VVS - VVS stainless steel
08	12.5	1/2"	TFVM 12 SR	●	
08	12.5	1/2"	TFRFS08 N	○	RFLS/RFS
08	12.5	1/2"	TF 12 S	○	2NS - 2NV - 4NV - AGRI - CNV
12	20	3/4"	TF 34 S	○	CNV - NL - NS - NV
12	20	3/4"	TFV 34 S	○	VV - VVS - VVS stainless steel
16	25	1"	TF 1 S	○	CNV - NS - NV
16	25	1"	TFV 1 S	○	VV - VVS - VVS stainless steel
20	31.5	1-1/4"	TF114 S	○	NV
20	31.5	1-1/4"	TFV114 S	○	VVS - VVS stainless steel
24	37.5	1-1/2"	TF112 S	○	NV
24	37.5	1-1/2"	TFH112 S	○	HNH - HNV brass - HNV stainless steel - TNL brass
32	50	2"	TF 2 S	○	NV
32	50	2"	TFH 2 S	○	HNH - HNV stainless steel
32	50	2"	TFV 2 S	○	VVS - VVS stainless steel

Aluminium dust protections



Dust protections for male couplings

Size			Details		
dash	mm	inch	Part number	Colour	Available for Series
04	6.3	1/4"	TF 2FI14 S	○	2FFI stainless steel - FFH
06	10	3/8"	TF 2FN38 S	○	2FFI stainless steel - 3FFH - FFH
08	12.5	1/2"	TFCVC 08 S	○	CVC
08	12.5	1/2"	TF 2FI12 S	○	2FFI brass - 2FFI stainless steel - 3FFH - FFH
12	20	3/4"	TFCVE 34 S	○	CVE
12	20	3/4"	TF 2FI34 S	○	2FFI stainless steel - 3FFH - FFH
16	25	1"	TFCVC 16 S	○	CVC
16	25	1"	TFCVE 1 S	○	CVE
16	25	1"	TF 2FI1 S	○	2FFI stainless steel - FFH

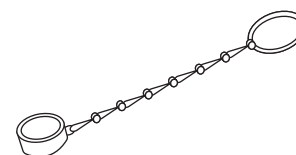

Dust protections for male couplings

Size			Details		
dash	mm	inch	Part number	Colour	Available for Series
04	6.3	1/4"	TFRF 04 S	○	RF
06	10	3/8"	TFRF 06 S N	○	RF - RFCS
08	12.5	1/2"	TFRF 08 S N	○	
12	20	3/4"	TFFB 12 S	○	FB
12	20	3/4"	TFRF 12 S N	○	RF - RFCS
16	25	1"	TFFB 16 S	○	FB
16	25	1"	TFRF 16 S N	○	RF - RFCS
20	31.5	1-1/4"	TFFB 20 S	○	FB
24	37.5	1-1/2"	TFFB 24 S	○	

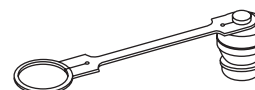

Dust protections for male couplings

Size			Details		
dash	mm	inch	Part number	Colour	Available for Series
04	6.3	1/4"	TFVV 04 S	○	CVV
06	10	3/8"	TFVV 06 S	○	
08	12,5	1/2"	TFVV 08 S	○	CVLS - CVV
16	25	1"	TFVV 16 S	○	
24	37.5	1-1/2"	TFVV 24 S	○	CVV

Aluminium dust protections



Dust protections for male couplings

Size			Details		
dash	mm	inch	Part number	Colour	Available for Series
12	20	3/4"	TF OGV12 S	○	OGV - OGVFR
16	25	1"	TF OGV16 S	○	
20	31.5	1-1/4"	TF OGV20 S	○	
24	37.5	1-1/2"	TF OGV24 S	○	OGV - OGVST
32	50	2"	TF OGV32 S	○	



Dust protections for male couplings

Size			Details		
dash	mm	inch	Part number	Colour	Available for Series
06	10	3/8"	TF FHV06 S	○	FHV
08	12.5	1/2"	TF FHV08 S	○	
12	20	3/4"	TF FHV12 S	○	FHV - FHVFR
16	25	1"	TF FHV16 S	○	
20	31.5	1-1/4"	TF FHV20 S	○	FHV
24	37.5	1-1/2"	TF FHV24 S	○	
32	50	2"	TF FHV32 S	○	



Dust protections for male couplings

Size			Details		
dash	mm	inch	Part number	Colour	Available for Series
20	31.5	1-1/4"	TF FFH 20 S	○	FFH

Stainless steel dust protections

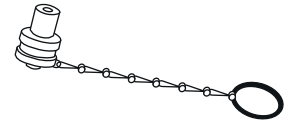

Dust protections for female couplings

Size			Details		
dash	mm	inch	Part number	Colour	Available for Series
04	6.3	1/4"	TMV 14 SS	○	VVS - VVS stainless steel
06	10	3/8"	TMV 38 SS	○	VV - VVS
08	12.5	1/2"	TMV 12 SS	○	VV - VVS - VVS stainless steel
12	20	3/4"	TMV 34 SS	○	
16	25	1"	TMV 1 SS	○	
20	31.5	1-1/4"	TMV114 SS	○	VVS - VVS stainless steel
24	37.5	1-1/2"	TMV112 SS	○	
32	50	2"	TMV 2 SS	○	

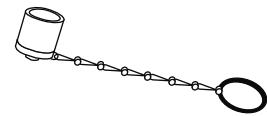

Dust protections for male couplings

Size			Details		
dash	mm	inch	Part number	Colour	Available for Series
08	12.5	1/2"	TFV 12 SS	○	VV - VVS - VVS stainless steel
12	20	3/4"	TFV 34 SS	○	
16	25	1"	TFV 1 SS	○	
20	31.5	1-1/4"	TFV114 SS	○	VVS - VVS stainless steel
24	37.5	1-1/2"	TFV112 SS	○	
32	50	2"	TFV 2 SS	○	

Lock washer for bulkhead mounting

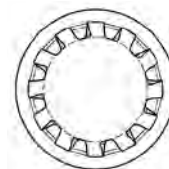

Dust protections for female couplings

Size			Details		
dash	mm	inch	Part number	Colour	Available for Series
04	6.3	1/4"	RDRF 04	●	RF
06	10	3/8"	RDRF 06	●	
08	12.5	1/2"	RDRF 08	●	
12	20	3/4"	RDRF 12	●	

Mounting flanges

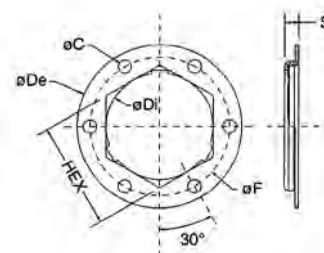

Dust protections for male couplings

Size			Details									
dash	mm	inch	$\varnothing De$ mm	$\varnothing Di$ mm	$\varnothing F$ mm	HEX mm	$\varnothing C$ mm	S mm	\varnothing Hole on the panel mm	Colour	Available for Series	
06	10	3/8"	46	22.5	39	22.6	3.8	4.7	21	+0.5 -0	●	RFCS
08	12.5	1/2"	50.8	28.7	42.9	28.7	5.1	5.5	25.9	+0.5 -0	●	
12	20	3/4"	63.5	41.4	53.9	41.4	5.1	5.5	36.8	+0.5 -0	●	
16	25	1"	69.9	47.8	60.5	47.8	5.1	5.5	44.9	+0.5 -0	●	

FastGrip

Line Identification System

Compatible with series AGRI - NV - NV stainless steel - CNV - 2NV - 4NV - 3CFHF - 3CKHF 4SRHF - 4SKHF

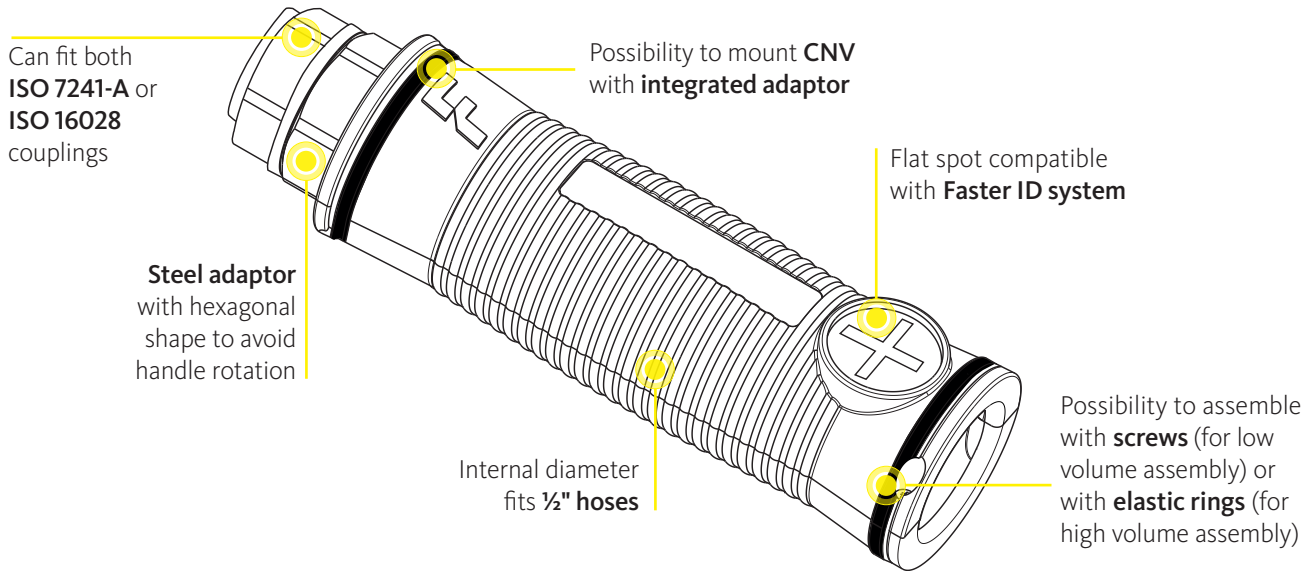

AVAILABLE KITS

Kits	Adaptor	Bonded	Screws	Shell	Elastic Ring
LM 12 GAS	✓		✓	✓	
LM BASE 08*			✓	✓	
Separate Assembly Kits	K LM ADAPTOR	K LM BONDED	K LM SCREW	K LM HALF SHELL	K LM EL RING

*CNV08LM2/.. M CNV couplings with integrated adaptor. This solution offers less leaking points.

MAIN ADVANTAGES

Visual

With Faster ID clips is possible to add information about the lines

Fits existing Oil Collecting System

The handle allows correct opening of oil caps when connected

Versatile

Any hydraulic hose can be retrofitted. Plastic handle designed to host majority of DIN adaptors

Perfect mix

Right weight, right compactness and right cost

DETAILS

Handle	Adaptor	Color	Working pressure	Burst pressure
PP plastic	Steel +	Black handle +	350 bar	1200 bar
UV additive	CrIII plating	Tags in various colors		
DIN adaptors	500 hours Salt Spray test			

AVAILABLE TAGS

Symbol	Color										
	Orange	White	Blue	Light Blue	Yellow	Grey	Brown	Black	Purple	Red	Green
+	ID A +	ID BI +	ID B +	ID C +	ID G +	ID GR +	ID M +	ID N +	ID P R4008 +	ID R +	ID V +
-	ID A -	ID BI -	ID B -	ID C -	ID G -	ID GR -	ID M -	ID N -	ID P R4008 -	ID R -	ID V -
1			ID B 1								ID V 1
2			ID B 2								ID V 2
3			ID B 3								ID V 3
4			ID B 4								ID V 4
5			ID B 5								ID V 5

Oil Collecting System

Available for Series 6DNPV - 3CFHF - 4SRHF - 3CKHF - 4SKHF

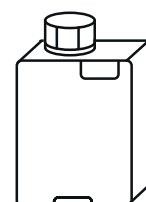
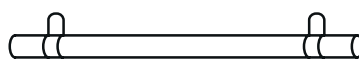
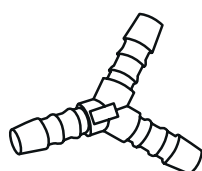
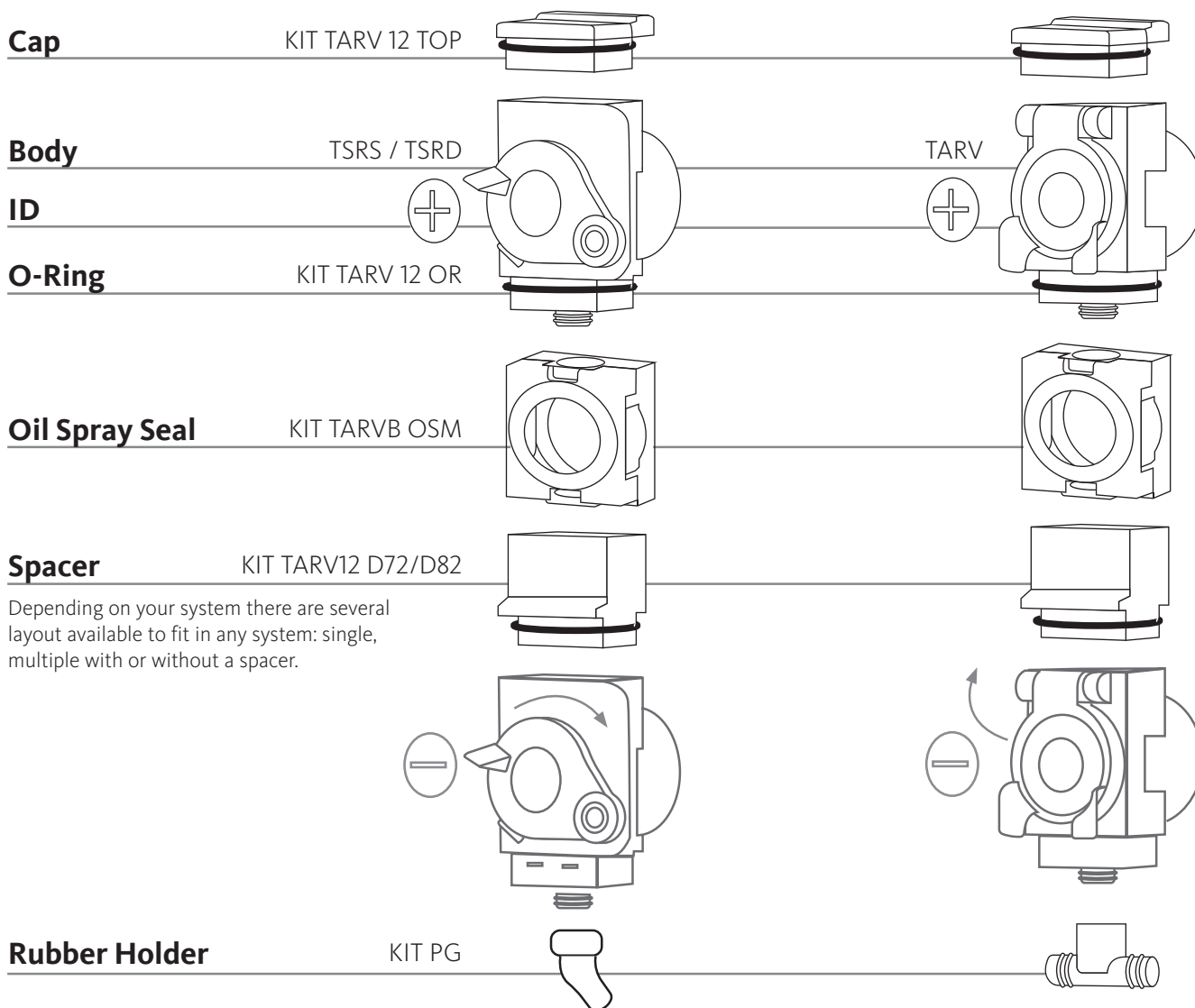

Kit TARV has several accessories to fit in any system such as plastic joints to connect dust protections and hoses, in different shapes according to configurations, or a plastic bottle to collect the dirty oil.

Each modular system is designed according to the available axle spacing between couplings. For more information, please contact Faster.

Seals Kits



Size			Details	
dash	mm	inch	Part number	Available for Series
02	3.2	1/8"	SK HNV 18	HNV - HNV brass
02	3.2	1/8"	SK HNV 18 V	
02	3.2	1/8"	SK FFH02	FFH
04	6.3	1/4"	SK TNV 04	TNV
04	6.3	1/4"	SK NV 14	NS - NV
04	6.3	1/4"	SK HNV 14	HNV - HNV brass
04	6.3	1/4"	SK HNV 14 V	HNV - HNV brass - HNV stainless steel
04	6.3	1/4"	SK MF 14	FFH
04	6.3	1/4"	SK NV 14	VV - VVS
04	6.3	1/4"	SK CVV 04	CVV
04	6.3	1/4"	SK PVVM 14	PVVM
04	6.3	1/4"	SK ANV 14	ANV
06	10	3/8"	SK TNV 06	TNV
06	10	3/8"	SK NV 38	NS - NV
06	10	3/8"	SK HNV 38	HNV - HNV brass
06	10	3/8"	SK HNV 38 V	HNV - HNV brass - HNV stainless steel
06	10	3/8"	SK FFH06 V	FFH
06	10	3/8"	SK FFH06	
06	10	3/8"	SK FHV06	FHV
06	10	3/8"	SK CVV 06	CVC
06	10	3/8"	SK PVVM 38	PVSM - PVVM
06	10	3/8"	SK ANV 38	ANV - CFPV - CPV
08	12.5	1/2"	SK TNV 12	TNV
08	12.5	1/2"	SK TNV 08	
08	12.5	1/2"	SK HNV 12	HNV - HNV brass
08	12.5	1/2"	SK HNV 12 V	HNV - HNV brass - HNV stainless steel
08	12.5	1/2"	SK NV 12	NL - NS - NV - SV
08	12.5	1/2"	SK FFH08 V	FFH
08	12.5	1/2"	SK FFH08	
08	12.5	1/2"	SK FHV08	FHV
08	12.5	1/2"	SK NV 38	VV - VVS
08	12.5	1/2"	SK CVV 12 V	CVC
08	12.5	1/2"	SK CVV 08 V	
08	12.5	1/2"	SK CVC 08	
08	12,5	1/2"	SK NV 12	VV - VVS
08	12.5	1/2"	KIT AE12S+OR12LT	6DNPV
08	12.5	1/2"	KIT AE12S+OR12H	3CFHF - 3CKHF - 4SKHF - 4SRHF
08	12.5	1/2"	SK NV 12	3CNV - 3CPV - 3NV - 4CPV - 4NV - 4PV - 4SPV - CFPV - CNV - CPV - PS - PV
10	16	5/8"	SK FFH10	FFH
12	20	3/4"	SK NV 34	NL - NS - NV

Seals Kits



Size			Details	
dash	mm	inch	Part number	Available for Series
12	20	3/4"	SK HNV 34	HNV - HNV brass - 4HNV
12	20	3/4"	SK HNV 34 V	HNV - HNV brass - HNV stainless steel - 4HNV
12	20	3/4"	SK FFH12	FFH
12	20	3/4"	SK FHV12	FHV
12	20	3/4"	SK NV 34	VV - VVS
12	20	3/4"	SK ANV 34	ANV - CFPV
16	25	1"	SK TNV 16	TNV
16	25	1"	SK NV 1	NS - NV
16	25	1"	SK HNV 1	HNV - HNV brass
16	25	1"	SK HNV 1 V	HNV - HNV brass - HNV stainless steel
16	25	1"	SK FFH16	FFH
16	25	1"	SK FHV16	FHV
16	25	1"	SK NV 1	VV - VVS
16	25	1"	SK CVV 16 V	CVV
16	25	1"	SK CVC 16	
16	25	1"	SK ANV 1	ANV - CPV
20	31.5	1-1/4"	SK TNV 20	TNV
20	31.5	1-1/4"	SK NV 114	NV
20	31.5	1-1/4"	SK FHV20	FHV
20	31.5	1-1/4"	SK VVS 114	VVS
20	31.5	1-1/4"	SK ANV 114	ANV
24	37.5	1-1/2"	SK TNV 24	TNV
24	37.5	1-1/2"	SK NV 112	NV
24	37.5	1-1/2"	SK HNV 112	HNV - HNV brass
24	37.5	1-1/2"	SK HNV 112 V	HNV - HNV brass - HNV stainless steel
24	37.5	1-1/2"	SK FHV24	FHV
24	37.5	1-1/2"	SK VVS 112	VVS
24	37.5	1-1/2"	SK CVV 24 V	CVV
24	37.5	1-1/2"	SK ANV 112	ANV
32	50	2"	SK TNV 32	TNV
32	50	2"	SK NV 2	NV
32	50	2"	SK HNV 2	HNV
32	50	2"	SK HNV 2 V	HNV - HNV brass - HNV stainless steel
32	50	2"	SK FHV32	FHV
32	50	2"	SK VVS 2	VVS
32	50	2"	SK ANV 2	ANV

Casting Solutions

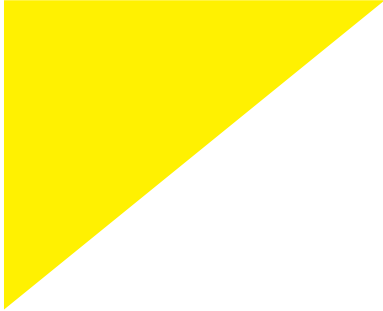

Castings equipped with cartridges and internal pressure eliminator.

4BD4FH	page 265
Flex Cart	page 267
4DCPV	page 269
Manifold blocks	page 271
5BM5DCPV	page 273
4BD4FH Cartridges replacement kit	page 274

The cast iron blocks shown in the pictures below are for illustrative purposes only.
The shape of each block is tailor designed to meet the manufacturer's space requirements.



4BD4FH

Castings with cartridges for Construction Equipment.

The first cast iron block ever designed to quickly connect and disconnect attachments on skid steers and other light equipment machines. The decompression feature allows to connect the circuit with residual pressure on both ends. 1/2" and 3/4" cartridges can both fit into the same block. Higher flow capability is guaranteed when using 3/4" cartridges instead of 1/2". Cartridges share all the benefits of the FFH/FSH couplings technology.



Applications



Pressure Drop

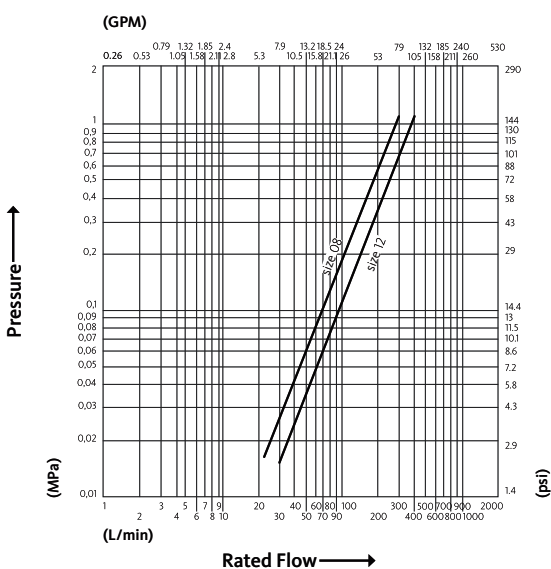

Test performed according to ISO 18869

Technical Specifications

dash	Size		Working Pressure (MPa)	Flow Rate (l/min)	Spillage (ml)	Force to Connect (N)	Burst pressure (MPa)		
	mm	inch					Male	Female	Male + Female
08	12.5	1/2"	35	100	0.01	200	125	125	125
12	20	3/4"	35	145	0.02	230	125	125	125

Material	Cast Iron; Steel
Seals	NBR; PUR
Working temperatures	- 25 °C to + 100 °C
Surface treatment	MATE 500 (CrIII); MATE 1000 (ZnNi)
Series Interchange	ISO 16028

Valve Type	Flat
Connection	Push to Connect
Disconnection	Sleeve Retraction
Connection Under Pressure	Allowed Both Halves up to W.P.



4DB4FH

Size		Thread details										
mm	inch	Thread Type	Standard	Thread	Part Number	L (L1 + Thread)		D1		HEX1		
						mm	inch	mm	inch	mm	inch	
12.5	1/2"	03/ METRIC	ISO 8434-1-S	M24x1.5 MALE 16S	4BD4FH08-3/2415	180	7.09					
12.5	1/2"	F BSPP	ISO 1179-1	BSPP 3/4 FEMALE	4BD4FH08-C	187.5	7.38					
12.5	1/2"	0/ SAE	ISO 11926-1	9/16"-18 UNF FEMALE ORB	4BD4FH08-58SAE	187.5	7.38					
12.5	1/2"	13/ SAE	ISO 8434-2	7/8"-14 UNF MALE JIC	4BD4FH08-13/58S	185	7.28					
12.5	1/2"	13/ SAE	ISO 8434-2	1-1/16"-12 UNF MALE JIC	4BD4FH08-13/34S	187.6	7.39					
20	3/4"	13/ SAE	ISO 8434-2	1-1/16"-12 UNF MALE JIC	4BD4FH12-13/34S	207.4	8.17					
20	3/4"	13/ SAE	ISO 8434-2	1-5/16"-12 UNF MALE JIC	4BD4FH12-13/1S	208.6	8.21					
20	3/4"	11/ SAE	ISO 8434-3	1-3/16"-12 UN MALE ORFS	4BD4FH12-11/34S	202.5	7.97					

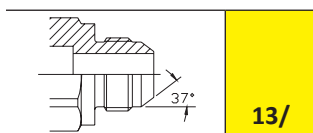
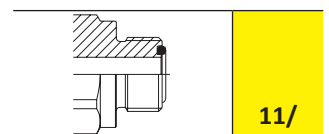
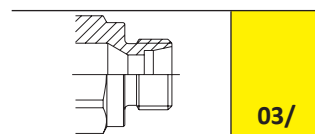
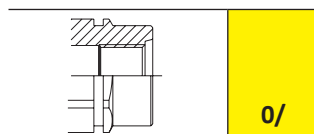
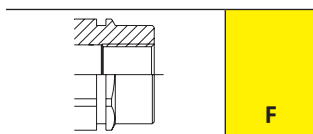



Flex Cart

New modular couplings to connect and disconnect rapidly hydraulic lines under residual pressure. To be customized according to the application needs.

The Flex Cart has the great benefit of modularity. The customer can compose the system according to number of lines, size and position on the equipment. The cartridges are installed in different brackets, according to the number of lines. Brackets can be painted by the customer with the machine color, thus helping the aesthetic look. Suitable for compact excavators, backhoe loaders, Compact Wheel Loaders and tele handlers.



Applications



Pressure Drop

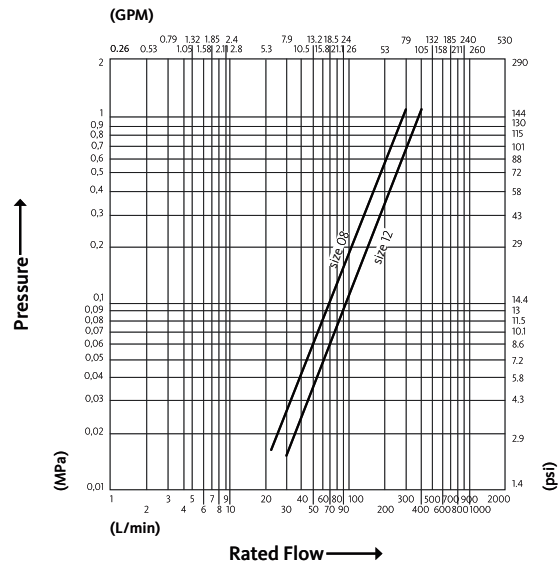

Test performed according to ISO 18869

Technical Specifications

dash	Size mm	inch	Working Pressure (MPa)	Flow Rate (l/min)	Spillage (ml)	Force to Connect (N)	Burst pressure (MPa)		
							Male	Female	Male + Female
08	12.5	1/2"	35	100	0.01	200	125	125	125
12	20	3/4"	36	145	0.02	230	125	125	125

Material	Steel
Seals	NBR; PUR
Working temperatures	- 15 °C to + 100 °C
Surface treatment	MATE 500 (CrIII); MATE 1000 (ZnNi)
Series Interchange	ISO 16028

Valve Type	Flat
Connection	Push to Connect
Disconnection	Sleeve Retraction
Connection Under Pressure	Allowed Residual



Flex Cart

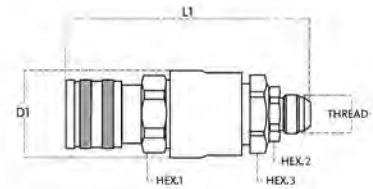

Size		Thread details			FEMALE											
mm	inch	Thread Type	Standard	Thread	Part Number	L (L1 + Thread)		D1		HEX1		HEX2		HEX2		
						mm	inch	mm	inch	mm	inch	mm	inch	mm	inch	
12.5	1/2"	0/ SAE	ISO 11926-1	7/16"-20 UNF FEMALE ORB	FFXD06F 14SAE	117	4.61	61.5	2.42	50	1.97	27	1.06	50	1.97	
12.5	1/2"	13/ SAE	ISO 8434-2	1-1/16"-12 UN MALE JIC	FFX08F-13/34S	153	6.02	61.5	2.42	50	1.97	34	1.34	50	1.97	
12.5	1/2"	13/ SAE	ISO 8434-2	1-1/16"-12 UN MALE JIC	FFX12F-13/34S	173	6.81	61.5	2.42	50	1.97	34	1.34	50	1.97	

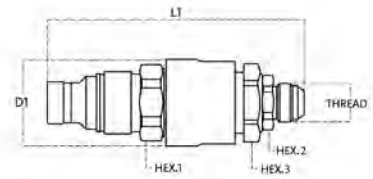

Size		Thread details			MALE											
mm	inch	Thread Type	Standard	Thread	Part Number	L (L1 + Thread)		D1		HEX1		HEX2		HEX2		
						mm	inch	mm	inch	mm	inch	mm	inch	mm	inch	
12.5	1/2"	0/ SAE	ISO 11926-1	7/16"-20 UNF FEMALE ORB	FFXD06M 14SAE	109	4.29	61.5	2.42	50	1.97	30	1.18	50	1.97	
12.5	1/2"	13/ SAE	ISO 8434-2	1-1/16"-12 UN MALE JIC	FFX08F-13/34S	150	5.91	61.5	2.42	50	1.97	34	1.34	50	1.97	
12.5	1/2"	13/ SAE	ISO 8434-2	1-1/16"-12 UN MALE JIC	FFX12F-13/34S	185	7.28	61.5	2.42	50	1.97	34	1.34	50	1.97	

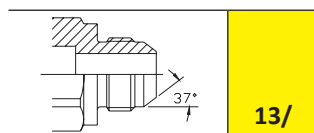
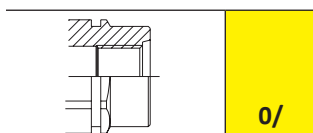

4DCPV

Applications



Custom-made casting solutions for agriculture with integrated cartridges.

The cast iron block is equipped with two integrated 1/2" cartridges, in accordance to ISO 7241 part A standard. Push-Pull connection type. Connection and disconnection under pressure allowed, thanks to the lever, specifically designed to ensure depressurization of the internal circuit. The block is designed to be screwed directly on control blocks. Every single casting is specifically developed for each tractor manufacturer, to meet impeding space requirements. Faster casting solutions are specifically designed to match the different control blocks interfaces available on the market. The lever can be mounted in different position, to meet space requirements.



Cartridges can be easily replaced. Easy to assemble and disassemble without special tools. Each kit contains rear seals and a smalley ring to retain the cartridge into the casting housing.

Replacement cartridge

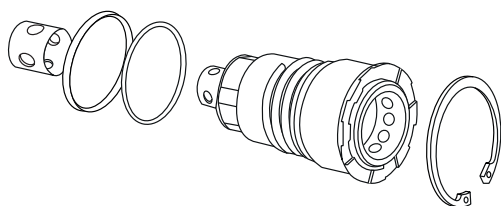

dash	Size		Part number	
	mm	inch		
08	12.5	1/2"	KIT4BM 4DCPVDS3	For castings with lever on top
08	12.5	1/2"	KIT4BM 4DCPVES3	For castings with lever on the side

Technical Specifications

Material	Cast Iron; Steel
Seals	HNBR; PUR
Working temperatures	- 25 °C to + 125 °C
Surface treatment	MATE 500 (CrIII)
Series Interchange	ISO 7241 part A

Valve Type	Poppet
Connection	Push to Connect or Lever
Disconnection	Lever
Connection Under Pressure	Allowed



Manifold blocks

Applications



Custom-made casting solutions for agriculture.

Cast iron manifold with 1/2" couplings screwed on. Designed to be screwed directly on control blocks. Every single casting is specifically developed for each tractor manufacturer, to meet impeding space requirements. Each Faster manifold block is specifically designed to match a specific control block interface. Each manifold can be equipped with different Female couplings for agriculture, depending on the required features. It can also be upgraded with compatible couplings of different series.



Manifold blocks can be equipped with couplings of the following series:



3CFHF



3CKHF



4SRHF



4SKHF



6DNPV

Please contact Faster for more information.

Technical Specifications

Material	Cast Iron; Steel	Valve Type	Poppet
Seals	NBR; PUR*	Connection	Push to Connect
Working temperatures	- 25 °C to + 125 °C	Disconnection	Pull to Disconnect
Surface treatment	MATE 500 (CrIII)	Connection Under Pressure	Allowed, depending on the mounted couplings
Series Interchange	ISO 7241 part A		

* Working temperatures: - 25 °C to + 100 °C

5BM5DCPV

Applications



Custom-made remote casting solutions for agriculture with integrated cartridges

The cast iron block is equipped with two integrated 1/2" or 3/4" cartridges, in accordance to ISO 7241 part A standard. Push-Pull connection type. Connection and disconnection under pressure allowed, thanks to the lever, specifically designed to ensure depressurization of the internal circuit. Thanks to its special design, it can be connected to the control block remotely, by means of rigid hoses.



Pressure Drop

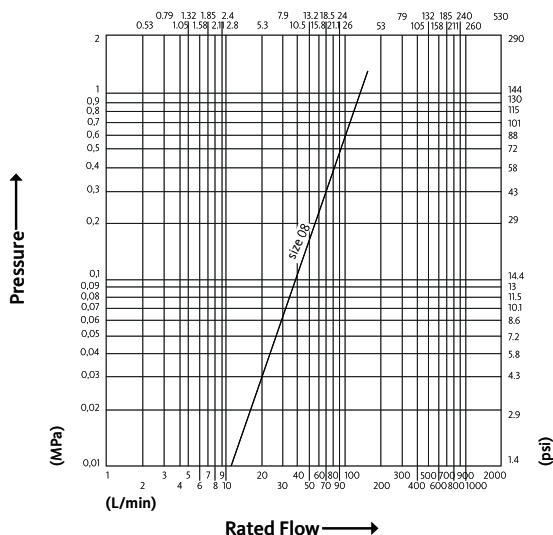

Test performed according to ISO 18869

Cartridges can be easily replaced. Easy to assemble and disassemble without special tools. Each kit contains rear seals and a smalley ring to retain the cartridge into the casting housing.

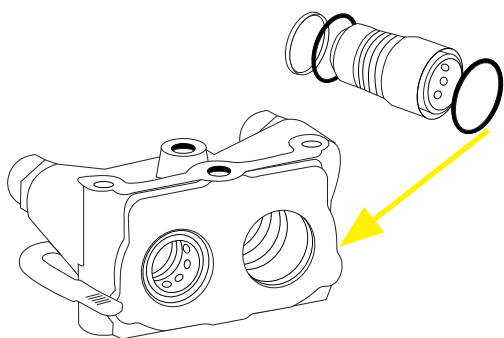

Replacement cartridge

dash	Size mm	inch	Part number
08	12.5	1/2"	KIT 5DCPVA08 A

Technical Specifications

Material	Cast Iron; Steel
Seals	HNBR; PUR
Working temperatures	- 25 °C to + 125 °C
Surface treatment	MATE 500 (CrIII)
Series Interchange	ISO 7241 part A

Valve Type	Poppet
Connection	Push to Connect or Lever
Disconnection	Lever
Connection Under Pressure	Allowed



4BD4FH Cartridges replacement kit

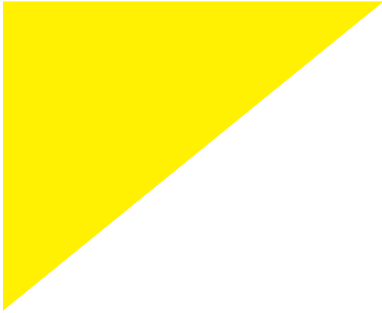

Easy to replace cartridges

page 275

Easy to replace cartridges

Size			Part number
dash	mm	inch	
08	12.5	1/2"	KIT 4FH08 M
08	12.5	1/2"	KIT 4FH08 F
08	12.5	1/2"	KIT 4FSH08 F
12	20	3/4"	KIT 4FH12 M
12	20	3/4"	KIT 4FH12 F

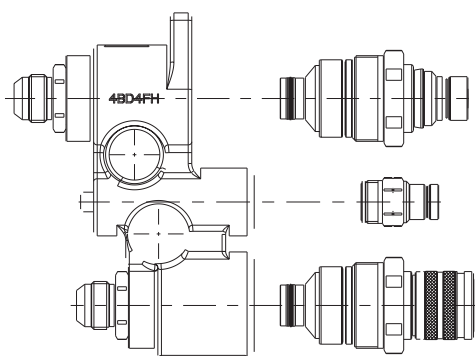

4BD4FH08

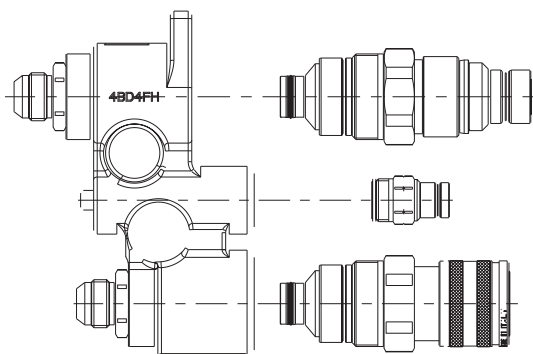

4BD4FH12



4FFH08 M



4FFH08 F



4FSH08 F



4FFH12 M



4FFH12 F

MultiFaster

System with lever that allows to connect several hydraulic lines simultaneously. Possibility to have electrical connection integrated.

MultiFaster Standard	page 278
MultiFaster Harvesting	page 344
MultiFaster G Type	page 352
MultiFaster High Pressure	page 368
MultiFaster - Accessories	page 380

MF Standard Pressure Drop

MultiFaster series 2

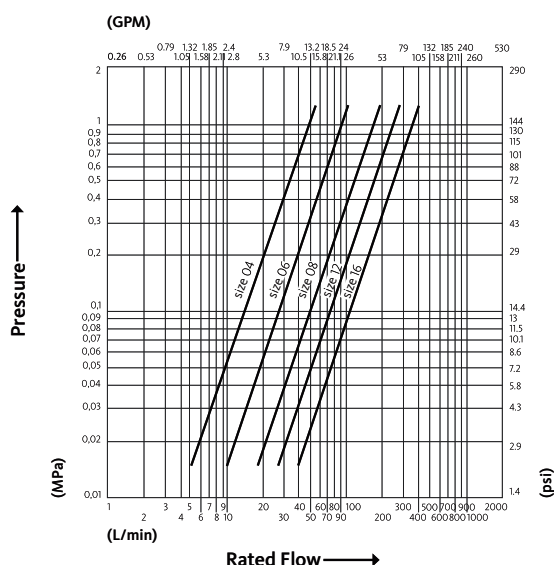

MultiFaster series 3

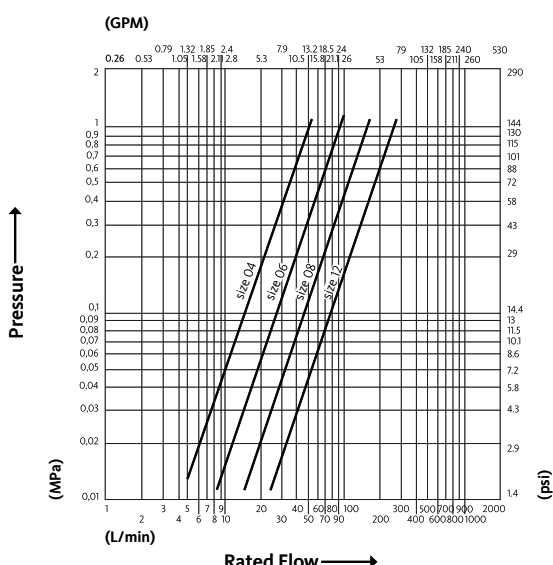

Test performed according to ISO 18869

Test performed according to ISO 18869

General nomenclature rules

Mobile half

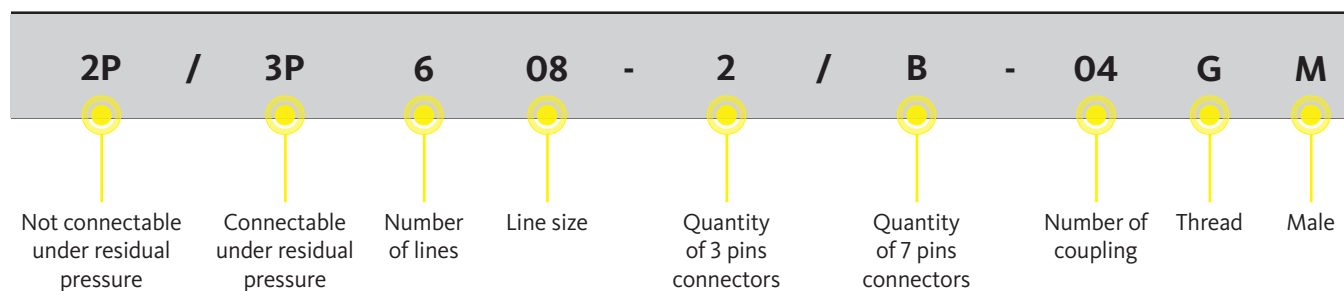

Fixed half

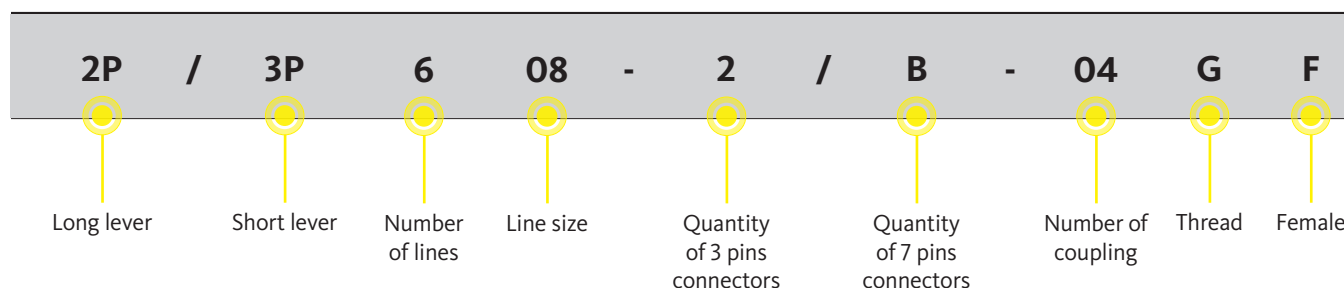

MultiFaster Standard

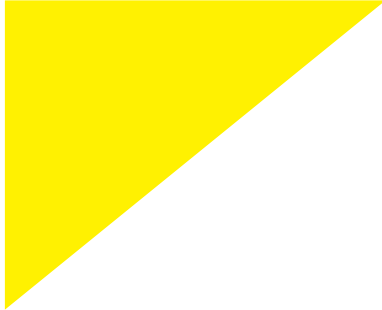

System with lever that allows to connect several hydraulic lines simultaneously. Possibility to have electrical connection integrated.

PB06	page 279
PC206	page 281
P206	page 283
P208	page 285
P306	page 287
P316	page 289
P404	page 291
P406A	page 293
P412	page 295
P506	page 297
P506-x	page 299
P508	page 303
MultiGrease	page 307
P510	page 309

PS06	page 313
PS06-x	page 315
PSA06	page 317
PS08	page 319
P5066	page 321
P606	page 323
P608	page 325
P5068	page 329
P808	page 331
P1004	page 333
P10A	page 335
P12A	page 337
P12B	page 339
P1504	page 341



MF PB06

MultiFaster 2 lines, size 06.

MultiFaster suitable for 2 lines size 06. Very compact overall dimensions.



Applications

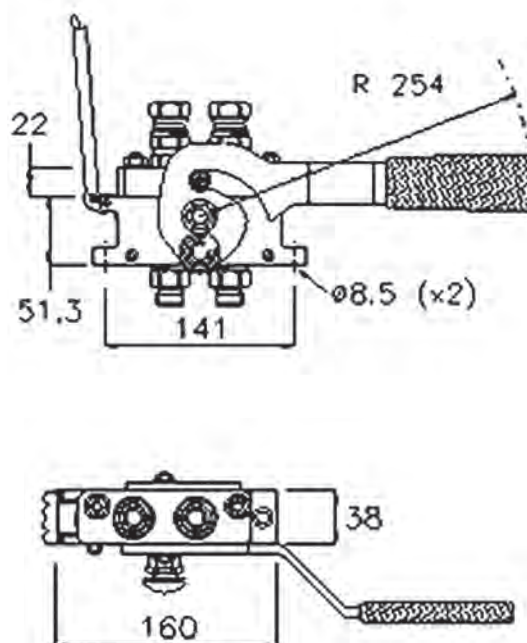

Technical Specifications

dash	Size		Working Pressure (MPa)	Flow Rate (l/min)	Spillage (ml)	Burst pressure (MPa)		
	mm	inch				Male	Female	Male + Female
06	10	3/8"	25	40	0.008	100	100	100

Material	Aluminium; Steel
Seals	NBR; PUR
Working temperatures	- 25 °C to + 100 °C
Surface treatment	MATE 500 (CrIII); Paint

Valve Type	Flat
Connection	Lever
Disconnection	Lever
Connection Under Pressure	Allowed Residual



PB06

Size					Thread Type					FIXED
dash	mm	inch	Housing	Number of Couplings	Thread Type	Standard	Thread	Electrical Connector N	Connector Type	Part Number
06	10	3/8"	2	2	02/ METRIC	ISO 8434-1-L	M22x1.5 MALE 15L			2PB06-2-2/22FC
06	10	3/8"	2	2	16/ BSPP	ISO 8434-6	60° 1/2 BSPP MALE			2PB06-2-16/DGFC
06	10	3/8"	2	2	16/ BSPP	ISO 8434-6	60° 3/8 BSPP MALE			2PB06-2-16/CGFC
06	10	3/8"	2	2	13/ SAE	ISO 8434-2	7/8"-14 UNF MALE JIC			2PB06-2-13/GSFC
06	10	3/8"	2	2	13/ SAE	ISO 8434-2	3/4"-16 UNF MALE JIC			2PB06-2-13/FSFC
06	10	3/8"	2	2	F BSPP	ISO 1179-1	BSPP 3/8" FEMALE			2PB06-2-38G FC
06	10	3/8"	2	2	F BSPP	ISO 1179-1	BSPP 1/2" FEMALE			2PB06-2-12G FC

Size					Thread Type					MOBILE
dash	mm	inch	Housing	Number of Couplings	Thread Type	Standard	Thread	Electrical Connector N	Connector Type	Part Number
06	10	3/8"	2	2	11/ SAE	ISO 8434-3	13/16"-16 UN MALE ORFS			3PB06-2-H M C
06	10	3/8"	2	2	20/ BSPP	BS 5200	1/2" BSPP FEMALE SWIVEL NUT			3PB06-2-20/DGMC
06	10	3/8"	2	2	02/ METRIC	ISO 8434-1-L	M22x1.5 MALE 15L			3PB06-2-2/22MC
06	10	3/8"	2	2	F NPTF	ANSI B1.20.3	NPTF 1/2" FEMALE			2PB06-2-12N MC
06	10	3/8"	2	2	F BSPP	ISO 1179-1	BSPP 1/2" FEMALE			3PB06-2-12G MC
06	10	3/8"	2	2	F BSPP	ISO 1179-1	BSPP 3/8" FEMALE			2PB06-2-38G MC
06	10	3/8"	2	2	F BSPP	ISO 1179-1	BSPP 1/2" FEMALE			2PB06-2-12G MC

Spare Parts & Accessories

Female Half				Male Half					
Plates	Lever	Dust cover	Safety Lock	Plates	Seals male	Screws	Plugs	Guiding pins	Docking
KIT PB06 F L	KIT LPB06	KIT TA PB06	KIT SP5 S	KIT PB06 M	SK MF 38	KIT VPB06	KIT TSP 12 M		S PB06

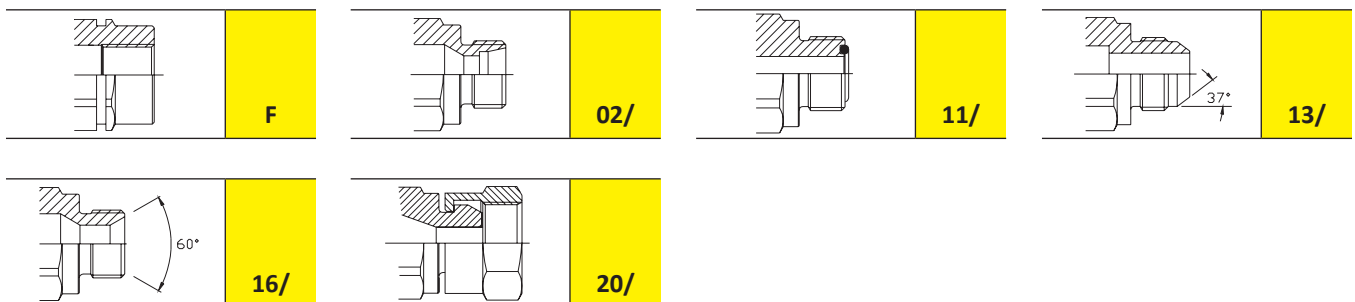



MF PC206

MultiFaster 2 lines, size 06.

MultiFaster compact. It allows connection with mobile plate or stand-alone counterpart couplings, 2 lines 3/8". The disconnection of stand-alone counterpart couplings is made by dedicated push buttons. This feature can be extended to all MultiFaster range.



Applications

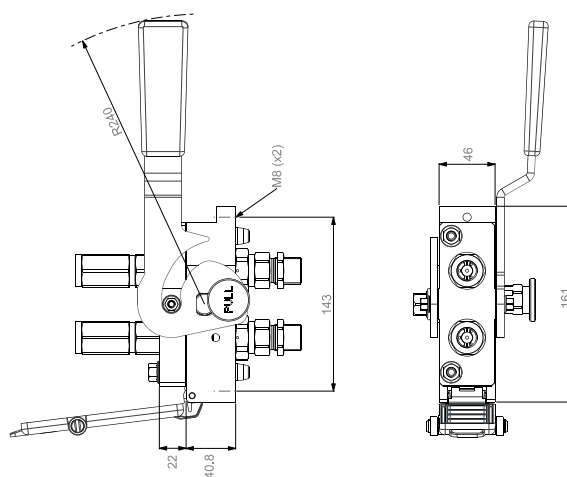

Technical Specifications

dash	Size		Working Pressure (MPa)	Flow Rate (l/min)	Spillage (ml)	Burst pressure (MPa)		
	mm	inch				Male	Female	Male + Female
06	10	3/8"	25	40	0.008	100	100	100

Material	Aluminium; Steel
Seals	NBR; PUR
Working temperatures	- 25 °C to + 100 °C
Surface treatment	MATE 500 (CrIII); Paint

Valve Type	Flat
Connection	Lever
Disconnection	Lever
Connection Under Pressure	Allowed Residual



PC206

Size					Thread Type					FIXED
dash	mm	inch	Housing	Number of Couplings	Thread Type	Standard	Thread	Electrical Connector N	Connector Type	Part Number
06	10	3/8"	2	2	07/METRIC	ISO 8434-1-L	M22X1.5 MALE BULKHEAD SHORT 15L			2PC206-2-7/22 FC

Size					Thread Type					MOBILE
dash	mm	inch	Housing	Number of Couplings	Thread Type	Standard	Thread	Electrical Connector N	Connector Type	Part Number
06	10	3/8"	2	2	F BSP	ISO 1179-1	BSP 3/8" FEMALE			3PC206-2-38G MC

Spare Parts & Accessories

Female Half				Male Half					
Plates	Lever	Dust cover	Safety Lock	Plates	Seals male	Screws	Plugs	Guiding pins	Docking
					SK MF 38		KIT TSP 12 M		

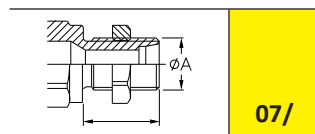
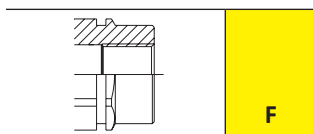



MF P206

MultiFaster 2 lines, size 06.

MultiFaster suitable for 2 lines size 06. Very compact design.

Applications

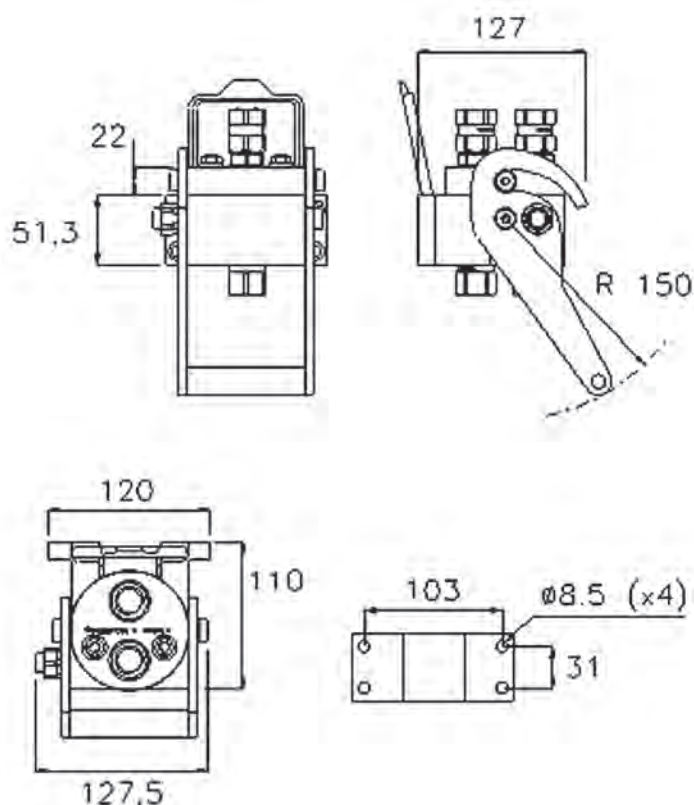

Technical Specifications

dash	Size		Working Pressure (MPa)	Flow Rate (l/min)	Spillage (ml)	Burst pressure (MPa)		
	mm	inch				Male	Female	Male + Female
06	10	3/8"	25	40	0.008	100	100	100

Material	Aluminium; Steel
Seals	NBR; PUR
Working temperatures	- 25 °C to + 100 °C
Surface treatment	MATE 500 (CrIII); Paint

Valve Type	Flat
Connection	Lever
Disconnection	Lever
Connection Under Pressure	Allowed Residual



P206

Size					Thread Type					FIXED
dash	mm	inch	Housing	Number of Couplings	Thread Type	Standard	Thread	Electrical Connector N	Connector Type	Part Number
06	10	3/8"	2	2	02/ METRIC	ISO 8434-1-L	M18x1.5 MALE 12L			2P206-2-2/18F C
06	10	3/8"	2	2	02/ METRIC	ISO 8434-1-L	M22x1.5 MALE 15L			2P206-2-2/22F C
06	10	3/8"	2	2	F BSPP	ISO 1179-1	BSPP 3/8" FEMALE			2P206-2-38G F C
06	10	3/8"	2	2	F BSPP	ISO 1179-1	BSPP 1/2" FEMALE			2P206-2-12G F C

Size					Thread Type					MOBILE
dash	mm	inch	Housing	Number of Couplings	Thread Type	Standard	Thread	Electrical Connector N	Connector Type	Part Number
06	10	3/8"	2	2	F BSPP	ISO 1179-1	BSPP 3/8" FEMALE			3P206-2-38G M C
06	10	3/8"	2	2	F BSPP	ISO 1179-1	BSPP 3/8" FEMALE			3P206-2-12G M C
06	10	3/8"	2	2	02/ METRIC	ISO 8434-1-L	M18x1,5 MALE 12L			2P206-2-2/18M C
06	10	3/8"	2	2	02/ METRIC	ISO 8434-1-L	M22x1.5 MALE 15L			2P206-2-2/22M C
06	10	3/8"	2	2	F BSPP	ISO 1179-1	BSPP 3/8" FEMALE			2P206-2-38G M C
06	10	3/8"	2	2	F BSPP	ISO 1179-1	BSPP 1/2" FEMALE			2P206-2-12G M C

Spare Parts & Accessories

Female Half				Male Half					
Plates	Lever	Dust cover	Safety Lock	Plates	Seals male	Screws	Plugs	Guiding pins	Docking
KIT P206 F L	KIT LP206	KIT TA P2	KIT SP4	KIT P206 M	SK MF 38	KIT VP4	KIT TSP 12 M	KIT GP4	S P2

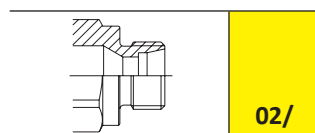
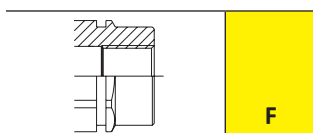



MF P208

MultiFaster 2 lines, size 08.

MultiFaster suitable for 2 lines size 08. Very compact design.

Applications

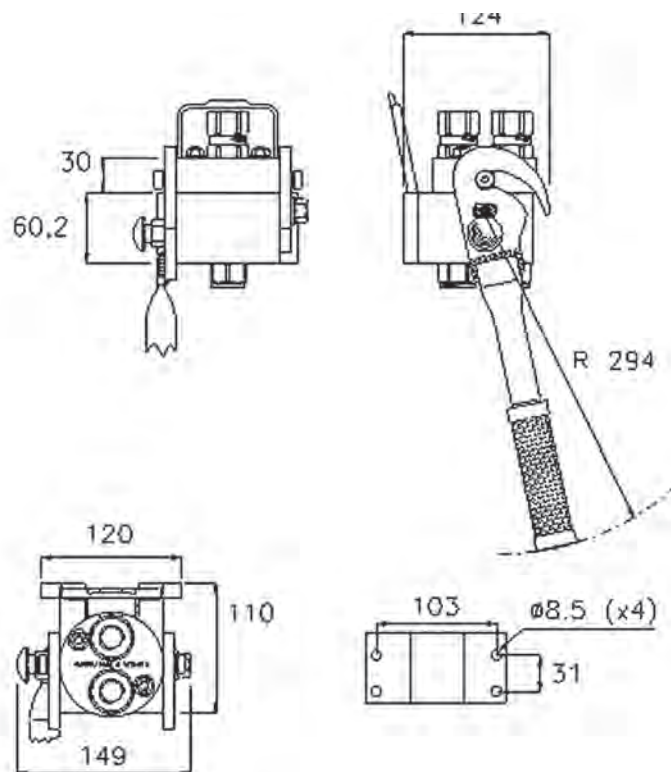

Technical Specifications

dash	Size		Working Pressure (MPa)	Flow Rate (l/min)	Spillage (ml)	Burst pressure (MPa)		
	mm	inch				Male	Female	Male + Female
08	12.5	1/2"	25	70	0.01	100	100	100

Material	Aluminium; Steel
Seals	NBR; PUR
Working temperatures	- 25 °C to + 100 °C
Surface treatment	MATE 500 (CrIII); Paint

Valve Type	Flat
Connection	Lever
Disconnection	Lever
Connection Under Pressure	Allowed Residual



P208

Size					Thread Type					FIXED
dash	mm	inch	Housing	Number of Couplings	Thread Type	Standard	Thread	Electrical Connector N	Connector Type	Part Number
08	12.5	1/2"	2	2	O/ SAE	ISO 11926-1	1 - 1/16" - 12 UN FEMALE ORB			2P208-2-34S F C
08	12.5	1/2"	2	2	F BSPP	ISO 1179-1	BSPP 3/4" FEMALE			2P208-2-34G F C
08	12.5	1/2"	2	2	02/ METRIC	ISO 8434-1-L	M22x1.5 MALE 15L			2P208-2-2/22F C
08	12.5	1/2"	2	2	O/ SAE	ISO 11926-1	3/4" - 16 UNF FEMALE ORB			2P208-2-12S F C
08	12.5	1/2"	2	2	F NPTF	ANSI B1.20.3	NPTF 1/2" FEMALE			2P208-2-12N F C
08	12.5	1/2"	2	2	F BSPP	ISO 1179-1	BSPP 1/2" FEMALE			3P208-2-12G F C
08	12.5	1/2"	2	2	F BSPP	ISO 1179-1	BSPP 1/2" FEMALE			2P208-2-12G F C

Size					Thread Type					MOBILE
dash	mm	inch	Housing	Number of Couplings	Thread Type	Standard	Thread	Electrical Connector N	Connector Type	Part Number
08	12.5	1/2"	2	2	O/ SAE	ISO 11926-1	1-1/16"-12 UN FEMALE ORB			3P208-2-34S M C
08	12.5	1/2"	2	2	F BSPP	ISO 1179-1	BSPP 1/2" FEMALE			3P208-2-34G M C
08	12.5	1/2"	2	2	O/ SAE	ISO 11926-1	1 - 1/16" - 12 UN FEMALE ORB			2P208-2-34S M C
08	12.5	1/2"	2	2	F BSPP	ISO 1179-1	BSPP 3/4" FEMALE			2P208-2-34G M C
08	12.5	1/2"	2	2	02/ METRIC	ISO 8434-1-L	M22x1.5 MALE 15L			2P208-2-2/22M C
08	12.5	1/2"	2	2	O/ SAE	ISO 11926-1	3/4" - 16 UNF FEMALE ORB			2P208-2-12S M C
08	12.5	1/2"	2	2	F NPTF	ANSI B1.20.3	NPTF 1/2" FEMALE			2P208-2-12N M C
08	12.5	1/2"	2	2	F BSPP	ISO 1179-1	BSPP 1/2" FEMALE			3P208-2-12G M C
08	12.5	1/2"	2	2	F BSPP	ISO 1179-1	BSPP 1/2" FEMALE			2P208-2-12G M C

Spare Parts & Accessories

Female Half				Male Half					
Plates	Lever	Dust cover	Safety Lock	Plates	Seals male	Screws	Plugs	Guiding pins	Docking
KIT P208 F L	KIT LP208	KIT TA P2	KIT SP5 S	KIT P208 M	SK MF 12	KIT VP8	KIT TSP 38 M	KIT GP4	S P2

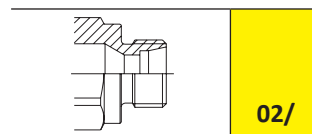
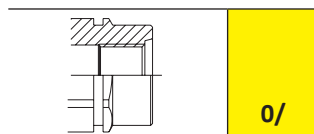
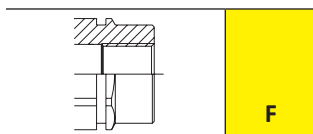



MF P306

MultiFaster 2 lines, size 06, 1 line size 08.

MultiFaster suitable for 2 lines size 06 and 1 line size 08.
Possibility to assemble the electrical connector within the 08 size housing.

Applications

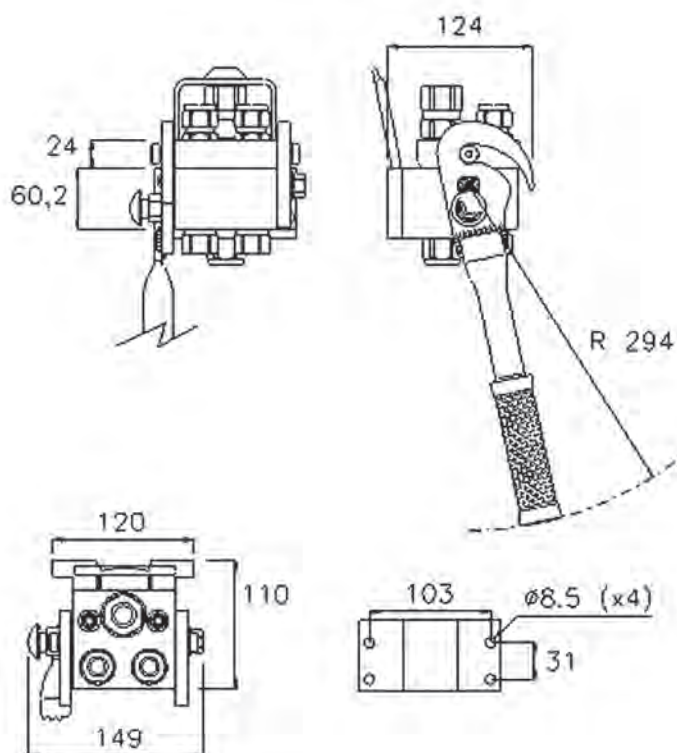

Technical Specifications

dash	Size mm	inch	Working Pressure (MPa)	Flow Rate (l/min)	Spillage (ml)	Burst pressure (MPa)		
						Male	Female	Male + Female
06	10	3/8"	25	40	0.008	100	100	100
08	12.5	1/2"	25	70	0.01	100	100	100

Material	Aluminium; Steel
Seals	NBR; PUR
Working temperatures	- 25 °C to + 100 °C
Surface treatment	MATE 500 (CrIII); Paint

Valve Type	Flat
Connection	Lever
Disconnection	Lever
Connection Under Pressure	Allowed Residual



P306

Size					Thread Type					FIXED
dash	mm	inch	Housing	Number of Couplings	Thread Type	Standard	Thread	Electrical Connector N	Connector Type	Part Number
06	10	3/8"	3	2	F BSPP	ISO 1179-1	BSPP 3/8" FEMALE			2P306-1-2-38GFC
08	12.5	1/2"						1	3 PINS	
06	10	3/8"	3	2	F BSPP	ISO 1179-1	BSPP 1/2" FEMALE			2P306-1-2-12GFC
08	12.5	1/2"						1	3 PINS	

Size					Thread Type					MOBILE
dash	mm	inch	Housing	Number of Couplings	Thread Type	Standard	Thread	Electrical Connector N	Connector Type	Part Number
06	10	3/8"	3	2	F BSPP	ISO 1179-1	BSPP 3/8" FEMALE			2P306-1-2-38GMC
08	12.5	1/2"						1	3 PINS	
06	10	3/8"	3	2	F BSPP	ISO 1179-1	BSPP 1/2" FEMALE			2P306-1-2-12GMC
08	12.5	1/2"						1	3 PINS	

Spare Parts & Accessories

Female Half				Male Half					
Plates	Lever	Dust cover	Safety Lock	Plates	Seals male	Screws	Plugs	Guiding pins	Docking
KIT P306 F L		KIT TA P2	KIT SP5 S	KIT P306 M	SK MF 38	KIT VP8	KIT TSP 38 M	KIT GP4	
					SK MF 12		KIT TSP 12 M		

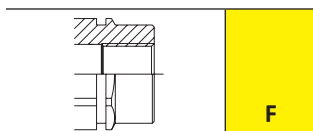



MF P316

MultiFaster 3 lines, size 16.

Applications

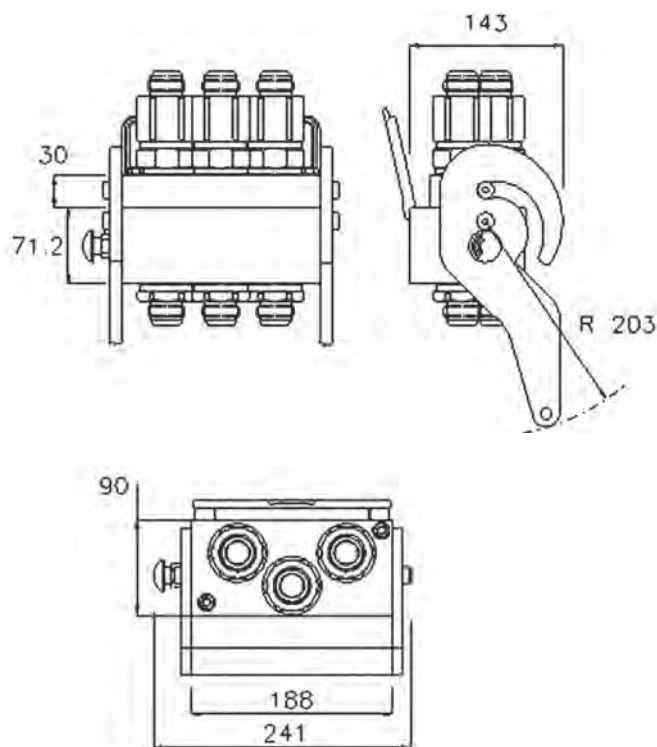

Technical Specifications

dash	Size		Working Pressure (MPa)	Flow Rate (l/min)	Spillage (ml)	Burst pressure (MPa)		
	mm	inch				Male	Female	Male + Female
16	25	1"	25	150	0.02	100	100	110

Material	Aluminium; Steel
Seals	NBR; PUR
Working temperatures	- 25 °C to + 100 °C
Surface treatment	MATE 500 (CrIII); Paint

Valve Type	Flat
Connection	Lever
Disconnection	Lever
Connection Under Pressure	Allowed Residual



P316

Size					Thread Type					FIXED
dash	mm	inch	Housing	Number of Couplings	Thread Type	Standard	Thread	Electrical Connector N	Connector Type	Part Number
16	25	1"	3	3	O/SAE	ISO 11926-1	1-5/16"-12 UN FEMALE ORB			2P316-3-1S F C
16	25	1"	3	3	F BSPP	ISO 1179-1	BSPP 1" FEMALE			2P316-3-1G F C
16	25	1"	3	2	O/SAE	ISO 11926-1	1-5/16"-12 UN FEMALE ORB			2P316-2-1S F C
16	25	1"	3	2	F BSPP	ISO 1179-1	BSPP 1" FEMALE			2P316-2-1G F C

Size					Thread Type					MOBILE
dash	mm	inch	Housing	Number of Couplings	Thread Type	Standard	Thread	Electrical Connector N	Connector Type	Part Number
16	25	1"	3	3	O/SAE	ISO 11926-1	1-5/16"-12 UN FEMALE ORB			3P316-3-1S M C
16	25	1"	3	3	F BSPP	ISO 1179-1	BSPP 1" FEMALE			3P316-3-1G M C
16	25	1"	3	2	O/SAE	ISO 11926-1	1-5/16"-12 UN FEMALE ORB			3P316-2-1S M C
16	25	1"	3	2	F BSPP	ISO 1179-1	BSPP 1" FEMALE			3P316-2-1G M C

Spare Parts & Accessories

Female Half				Male Half					
Plates	Lever	Dust cover	Safety Lock	Plates	Seals male	Screws	Plugs	Guiding pins	Docking
KIT P4A F L		KIT TA P10	KIT SP5 S		SK MF 1	KIT VP116			





MF P404

MultiFaster 4 lines, size 04.

Applications

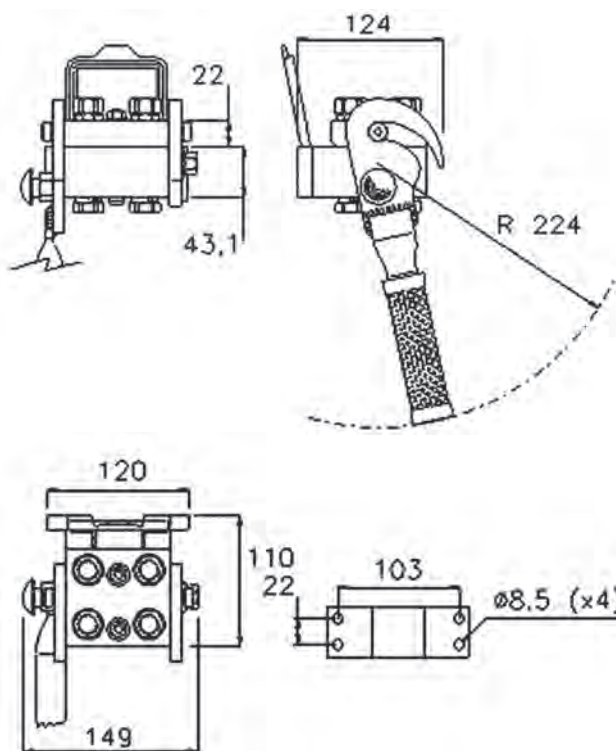

Technical Specifications

dash	Size		Working Pressure (MPa)	Flow Rate (l/min)	Spillage (ml)	Burst pressure (MPa)		
	mm	inch				Male	Female	Male + Female
04	6.3	1/4"	25	20	0.008	100	100	100

Material	Aluminium; Steel
Seals	NBR; PUR
Working temperatures	- 25 °C to + 100 °C
Surface treatment	MATE 500 (CrIII); Paint

Valve Type	Flat
Connection	Lever
Disconnection	Lever
Connection Under Pressure	Allowed Residual



P404

Size					Thread Type					FIXED
dash	mm	inch	Housing	Number of Couplings	Thread Type	Standard	Thread	Electrical N	Connector Type	Part Number
04	6.3	1/4"	4	4	F BSPP	ISO 1179-1	BSPP 1/4" FEMALE			2P404-4-14G F C
04	6.3	1/4"	4	3	13/ SAE	ISO 8434-2	1/2"-20 UNF MALE JIC			2P404-3-A F C

Size					Thread Type					MOBILE
dash	mm	inch	Housing	Number of Couplings	Thread Type	Standard	Thread	Electrical N	Connector Type	Part Number
04	6.3	1/4"	4	4	F BSPP	ISO 1179-1	BSPP 1/4" FEMALE			2P404-4-14G M C
04	6.3	1/4"	4	3	20/ BSPP	ISO 8434-6	"BSPP 1/2"" FEMALE SWIVEL NUT			2P404-3-A M C

Spare Parts & Accessories

Female Half				Male Half					
Plates	Lever	Dust cover	Safety Lock	Plates	Seals male	Screws	Plugs	Guiding pins	Docking
		KIT TA P2	KIT SP5 S		SK MF 14	KIT VP8		KIT GP4	S P404

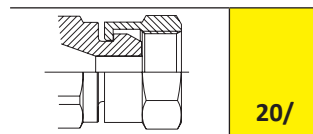
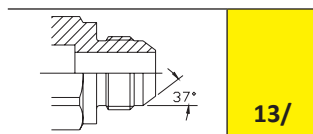
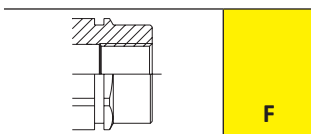



MF P406A

MultiFaster 4 lines, size 06.

Applications

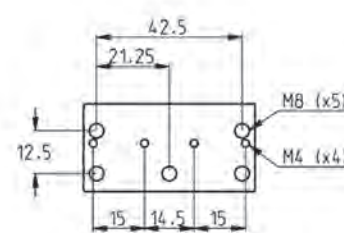
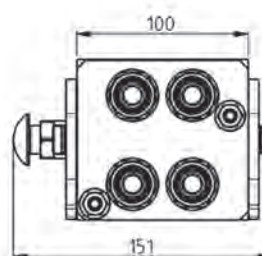
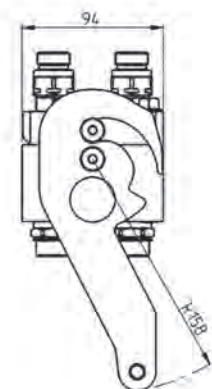
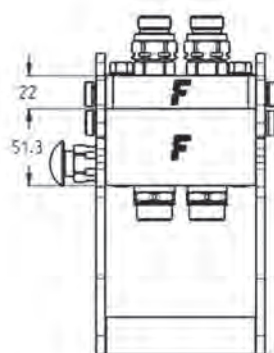

Technical Specifications

dash	Size		Working Pressure (MPa)	Flow Rate (l/min)	Spillage (ml)	Burst pressure (MPa)		
	mm	inch				Male	Female	Male + Female
06	10	3/8"	25	40	0.008	100	100	110

Material	Aluminium; Steel
Seals	NBR; PUR
Working temperatures	- 25 °C to + 100 °C
Surface treatment	MATE 500 (CrIII); Paint

Valve Type	Flat
Connection	Lever
Disconnection	Lever
Connection Under Pressure	Allowed Residual



P406A

Size					Thread Type					FIXED
dash	mm	inch	Housing	Number of Couplings	Thread Type	Standard	Thread	Electrical Connector N	Connector Type	Part Number
06	10	3/8"	4	4	02/ METRIC	ISO 8434-1-L	M18x1.5 MALE 12L			2P406A-4-2/18FC

Size					Thread Type					MOBILE
dash	mm	inch	Housing	Number of Couplings	Thread Type	Standard	Thread	Electrical Connector N	Connector Type	Part Number
06	10	3/8"	4	4	02/ METRIC	ISO 8434-1-L	M18x1,5 MALE 12L			2P406A-4-2/18MC

Spare Parts & Accessories

Female Half				Male Half					
Plates	Lever	Dust cover	Safety Lock	Plates	Seals male	Screws	Plugs	Guiding pins	Docking
			KIT SP5 S		SK MF 38		KIT TSP 12 M	KIT GP4	

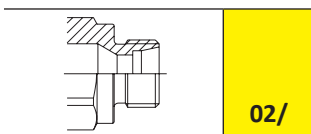



MF P412

MultiFaster 4 lines, size 12.

Applications

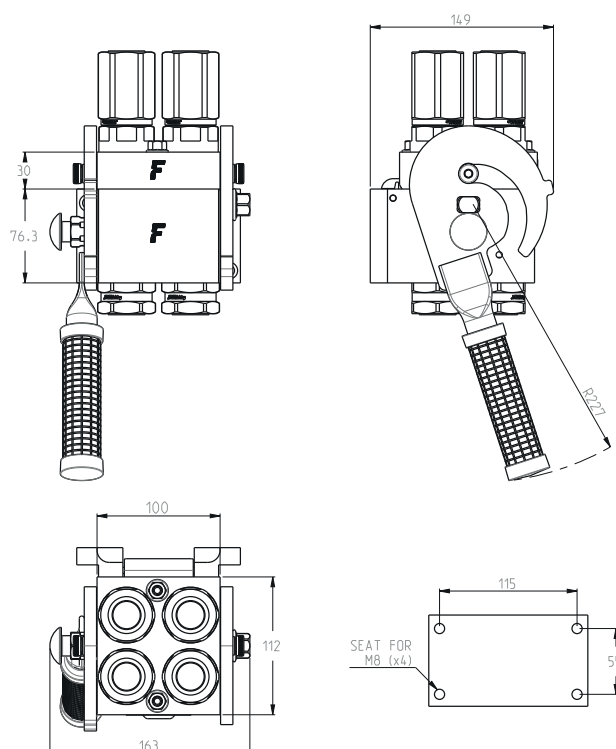

Technical Specifications

dash	Size		Working Pressure (MPa)	Flow Rate (l/min)	Spillage (ml)	Burst pressure (MPa)		
	mm	inch				Male	Female	Male + Female
12	20	3/4"	25	105	0.02	100	100	110

Material	Aluminium; Steel
Seals	NBR; PUR
Working temperatures	- 25 °C to + 100 °C
Surface treatment	MATE 500 (CrIII); Paint

Valve Type	Flat
Connection	Lever
Disconnection	Lever
Connection Under Pressure	Allowed Residual



P412

Size					Thread Type					FIXED
dash	mm	inch	Housing	Number of Couplings	Thread Type	Standard	Thread	Electrical Connector N	Connector Type	Part Number
12	20	3/4"	4	4	F BSPP	ISO 1179-1	BSPP 3/4" FEMALE			3P412-4-34G F C

Size					Thread Type					MOBILE
dash	mm	inch	Housing	Number of Couplings	Thread Type	Standard	Thread	Electrical Connector N	Connector Type	Part Number
12	20	3/4"	4	4	F BSPP	ISO 1179-1	BSPP 3/4" FEMALE			3P412-4-34G M C

Spare Parts & Accessories

Female Half				Male Half					
Plates	Lever	Dust cover	Safety Lock	Plates	Seals male	Screws	Plugs	Guiding pins	Docking
		KIT TA P5			SK MF 34		KIT TSP 34 M	KIT GP4	

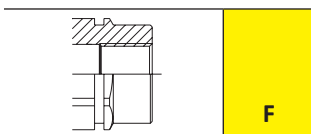



MF P506

MultiFaster 4 lines, size 06.

Applications

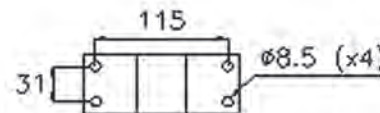
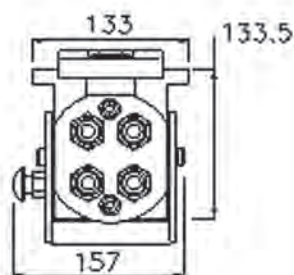
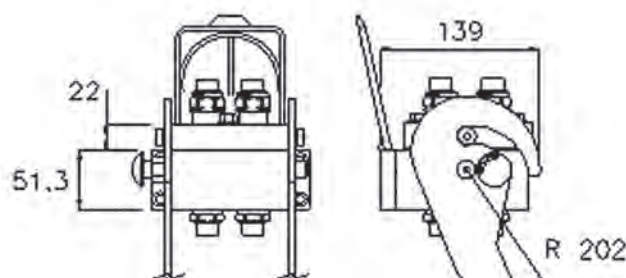

Technical Specifications

dash	Size		Working Pressure (MPa)	Flow Rate (l/min)	Spillage (ml)	Burst pressure (MPa)		
	mm	inch				Male	Female	Male + Female
06	10	3/8"	25	40	0.008	100	100	100

Material	Aluminium; Steel
Seals	NBR; PUR
Working temperatures	- 25 °C to + 100 °C
Surface treatment	MATE 500 (CrIII); Paint

Valve Type	Flat
Connection	Lever
Disconnection	Lever
Connection Under Pressure	Allowed Residual



P506

Size					Thread Type					FIXED
dash	mm	inch	Housing	Number of Couplings	Thread Type	Standard	Thread	Electrical Connector N	Connector Type	Part Number
06	10	3/8"	4	4	03/ METRIC	ISO 8434-1-S	M20x1.5 MALE 12S			2P506-4-3/20F C
06	10	3/8"	4	4	02/ METRIC	ISO 8434-1-L	M18x1.5 MALE 12L			2P506-4-2/18F C
06	10	3/8"	4	3	F BSPP	ISO 1179-1	BSPP 3/8" FEMALE			2P506-3-38G F C
06	10	3/8"	4	4	02/ METRIC	ISO 8434-1-L	M22x1.5 MALE 15L			2P506-4-2/22F C
06	10	3/8"	4	4	F BSPP	ISO 1179-1	BSPP 3/8" FEMALE			2P506-4-38G F C
06	10	3/8"	4	4	F BSPP	ISO 1179-1	BSPP 1/2" FEMALE			2P506-4-12G F C

Size					Thread Type					MOBILE
dash	mm	inch	Housing	Number of Couplings	Thread Type	Standard	Thread	Electrical Connector N	Connector Type	Part Number
06	10	3/8"	4	4	03/ METRIC	ISO 8434-1-S	M20x1.5 MALE 12S			3P506-4-3/20M C
06	10	3/8"	4	4	0/ SAE	ISO 11926-1	3/4" - 16 UNF FEMALE ORB			3P506-4-12S M C
06	10	3/8"	4	4	F BSPP	ISO 1179-1	BSPP 1/2" FEMALE			3P506-4-12G M C
06	10	3/8"	4	4	F NPTF	ANSI B1.20.3	NPTF 3/8" FEMALE			2P506-4-38N M C
06	10	3/8"	4	4	02/ METRIC	ISO 8434-1-L	M18x1,5 MALE 12L			2P506-4-2/18M C
06	10	3/8"	4	3	F BSPP	ISO 1179-1	BSPP 3/8" FEMALE			2P506-3-38G M C
06	10	3/8"	4	4	F BSPP	ISO 1179-1	BSPP 3/8" FEMALE			3P506-4-38G M C
06	10	3/8"	4	4	F BSPP	ISO 1179-1	BSPP 3/8" FEMALE			2P506-4-38G M C
06	10	3/8"	4	4	02/ METRIC	ISO 8434-1-L	M22x1,5 MALE 15L			2P506-4-2/22M C
06	10	3/8"	4	4	F BSPP	ISO 1179-1	BSPP 1/2" FEMALE			2P506-4-12G M C

Spare Parts & Accessories

Female Half				Male Half					
Plates	Lever	Dust cover	Safety Lock	Plates	Seals male	Screws	Plugs	Guiding pins	Docking
KIT P506 F L	KIT LP506	KIT TA P5	KIT SP5 S	KIT P506 M	SK MF 38	KIT VP4	KIT TSP 12 M	KIT GP4	S P5

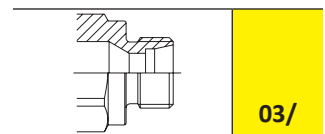
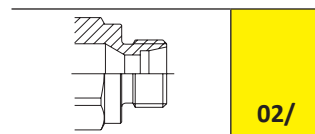
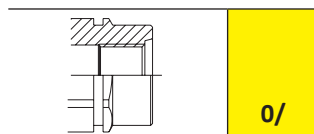
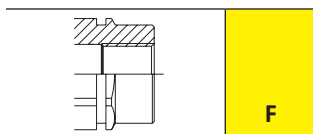



MF P506-x

MultiFaster 5 lines (4 lines 06 and 1 line 08).
The line 08 can be replaced by an electrical connector.

Applications

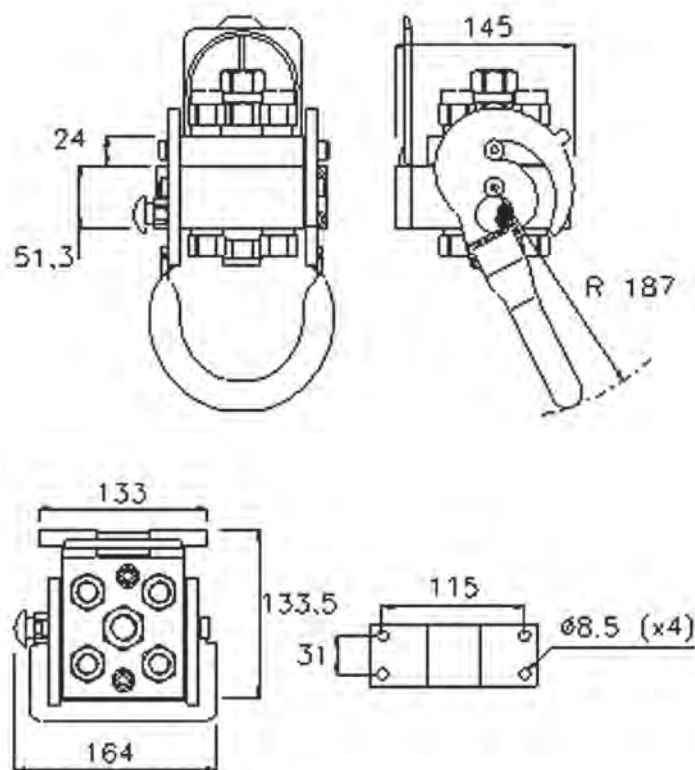

Technical Specifications

dash	Size		Working Pressure (MPa)	Flow Rate (l/min)	Spillage (ml)	Burst pressure (MPa)		
	mm	inch				Male	Female	Male + Female
06	10	3/8"	25	40	0.008	100	100	100
08	12.5	1/2"	25	70	0.01	100	100	100

Material	Aluminium; Steel
Seals	NBR; PUR
Working temperatures	- 25 °C to + 100 °C
Surface treatment	MATE 500 (CrIII); Paint

Valve Type	Flat
Connection	Lever
Disconnection	Lever
Connection Under Pressure	Allowed Residual



P506-x

Size			Housing	Number of Couplings	Thread Type			Electrical Connector		FIXED
dash	mm	inch			Thread Type	Standard	Thread	N	Type	Part Number
06	10	3/8"	5	4	F BSPP	ISO 1179-1	BSPP 3/8" FEMALE	1	7 PINS	2P506-A-4-38GFC
08	12.5	1/2"								
06	10	3/8"	5	4	F BSPP	ISO 1179-1	BSPP 3/8" FEMALE	1	3 PINS	2P506-1-4-38GFC
08	12.5	1/2"								
06	10	3/8"	5	4	F BSPP	ISO 1179-1	BSPP 3/8" FEMALE			2P506-0-5-S0 FC
08	12.5	1/2"								
06	10	3/8"	4	4	02/ METRIC	ISO 8434-1-L	M22x1.5 MALE 15L	1	7 PINS	2P506-A-4-2/2FC
08	12.5	1/2"								
06	10	3/8"	5	4	02/ METRIC	ISO 8434-1-L	M22x1.5 MALE 15L			2P506-0-5-S4 FC
08	12.5	1/2"								
06	10	3/8"	5	4	F BSPP	ISO 1179-1	BSPP 1/2" FEMALE	1	3 PINS	2P506-1-4-12GFC
08	12.5	1/2"								
06	10	3/8"	5	4	02/ METRIC	ISO 8434-1-L	M22x1.5 MALE 15L	1	3 PINS	2P506-1-4-2/2FC
08	12.5	1/2"								

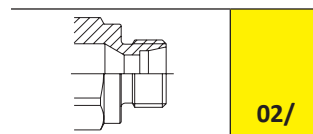
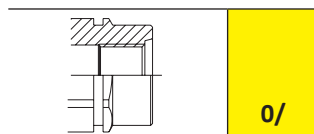
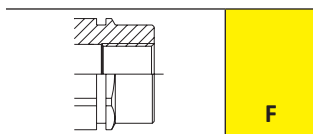

P506-x

Size					Thread Type					MOBILE
dash	mm	inch	Housing	Number of Couplings	Thread Type	Standard	Thread	Electrical N	Connector Type	Part Number
06	10	3/8"	5	4	F BSPP	ISO 1179-1	BSPP 3/8" FEMALE			3P506-A-4-38GMC
08	12.5	1/2"		1				1	7 PINS	
06	10	3/8"	5	4	F BSPP	ISO 1179-1	BSPP 3/8" FEMALE			2P506-A-4-38GMC
08	12.5	1/2"		1				1	7 PINS	
06	10	3/8"	5	4	F BSPP	ISO 1179-1	BSPP 3/8" FEMALE			2P506-1-4-38GMC
08	12.5	1/2"		1				1	3 PINS	
06	10	3/8"	5	4	F BSPP	ISO 1179-1	BSPP 3/8" FEMALE			2P506-0-5-S0 MC
08	12.5	1/2"		1	F BSPP	ISO 1179-1	BSPP 1/2" FEMALE			
06	10	3/8"	5	3	O/ BSPP	BS 5380	3/8 BSP FEMALE ORB			2P506-0-5-A M C
06	10	3/8"		1	O2/ METRIC	ISO 8434-1-L	M22x1.5 MALE 15L			
08	12.5	1/2"		1	O2/ METRIC	ISO 8434-1-L	M22x1.5 MALE 15L			
06	10	3/8"	5	4	O2/ METRIC	ISO 8434-1-L	M22x1.5 MALE 15L			2P506-0-4-2/2MC
06	10	3/8"	5	4	O2/ METRIC	ISO 8434-1-L	M22x1.5 MALE 15L			2P506-A-4-2/2MC
08	12.5	1/2"		1				1	7 PINS	
06	10	3/8"	5	4	F BSPP	ISO 1179-1	BSPP 1/2" FEMALE			2P506-1-4-12GMC
08	12.5	1/2"		1				1	3 PINS	
06	10	3/8"	5	4	O2/ METRIC	ISO 8434-1-L	M22x1.5 MALE 15L			2P506-0-5-S4 MC
08	12.5	1/2"		1	O2/ METRIC	ISO 8434-1-L	M22x1.5 MALE 15L			
06	10	3/8"	5	4	O2/ METRIC	ISO 8434-1-L	M22x1.5 MALE 15L			2P506-1-4-2/2MC
08	12.5	1/2"		1				1	3 PINS	

Spare Parts & Accessories

Female Half				Male Half					
Plates	Lever	Dust cover	Safety Lock	Plates	Seals male	Screws	Plugs	Guiding pins	Docking
KIT P506-1 F L	KIT LP506-1			KIT P506-1 M	SK MF 38		KIT TSP 38 M		S P5
					SK MF 12		KIT TSP 12 M		

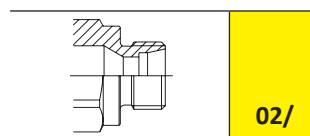
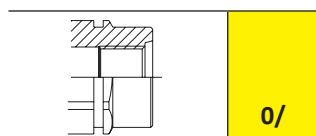
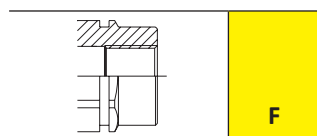

MF P508



MultiFaster 4 lines, size 08.

Applications

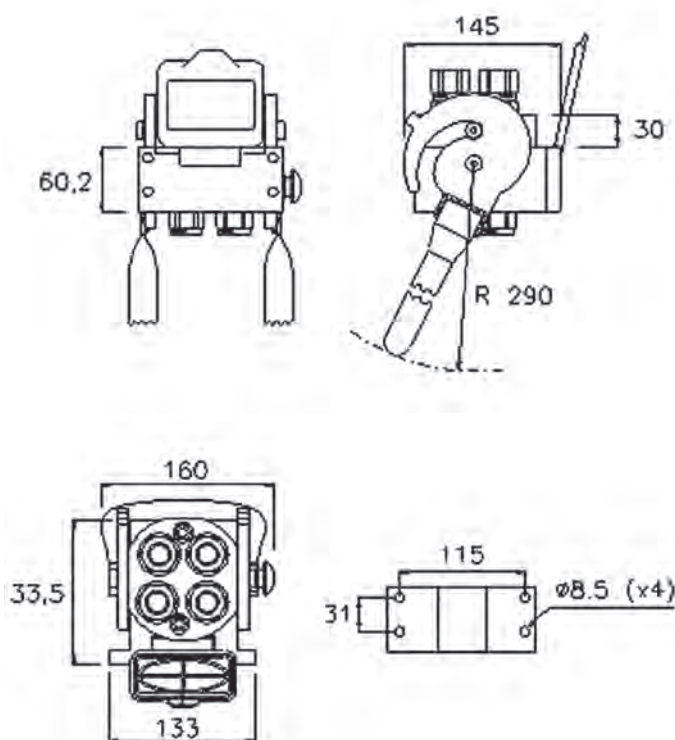

Technical Specifications

dash	Size		Working Pressure (MPa)	Flow Rate (l/min)	Spillage (ml)	Burst pressure (MPa)		
	mm	inch				Male	Female	Male + Female
08	12.5	1/2"	25	70	0.01	100	100	100

Material	Aluminium; Steel
Seals	NBR; PUR
Working temperatures	- 25 °C to + 100 °C
Surface treatment	MATE 500 (CrIII); Paint

Valve Type	Flat
Connection	Lever
Disconnection	Lever
Connection Under Pressure	Allowed Residual



P508

Size					Thread Type					FIXED
dash	mm	inch	Housing	Number of Couplings	Thread Type	Standard	Thread	Electrical Connector N	Connector Type	Part Number
04	6.3	1/4"	4	1	F BSPP	ISO 1179-1	BSPP 1/2" FEMALE			2P508-A-2-B F C
08	12.5	1/2"		1	F BSPP	ISO 1179-1	BSPP 1/4" FEMALE			
08	12.5	1/2"						1	7 PINS	
08	12.5	1/2"	4	4	F BSPP	ISO 1179-1	BSPP 1/2" FEMALE			2P508-4-F F C*
08	12.5	1/2"	4	4	O/ SAE	ISO 11926-1	1 - 1/16" - 12 UN FEMALE ORB			2P508-4-34S F C
08	12.5	1/2"	4	4	O3/ METRIC	ISO 8434-1-S	M24x1.5 MALE 16S			2P508-4-3/24F C
08	12.5	1/2"	4	4	O/ SAE	ISO 11926-1	3/4" - 16 UNF FEMALE ORB			2P508-4-12S F C
08	12.5	1/2"	4	4	F NPTF	ANSI B1.20.4	NPTF 1/2" FEMALE			2P508-4-12N F C
08	12.5	1/2"	4	3	O/ SAE	ISO 11926-1	3/4" - 16 UNF FEMALE ORB			2P508-3-12S F C
08	12.5	1/2"	4	2	F BSPP	ISO 1179-1	BSPP 1/2" FEMALE			2P508-2-2-12GFC
08	12.5	1/2"						2	3 PINS	
08	12.5	1/2"	4	3	F BSPP	ISO 1179-1	BSPP 1/2" FEMALE			2P508-1-3-12GFC
08	12.5	1/2"						1	3 PINS	
08	12.5	1/2"	4	3	F BSPP	ISO 1179-1	BSPP 1/2" FEMALE			3P508-3-12GFATC
08	12.5	1/2"	4	4	F BSPP	ISO 1179-1	BSPP 1/2" FEMALE			3P508-4-12G F C
08	12.5	1/2"	4	4	F BSPP	ISO 1179-1	BSPP 1/2" FEMALE			2P508-4-12G F C

* 1 coupling in stainless steel with seals in FKM. 3 couplings in steel with seals in NBR - PUR.

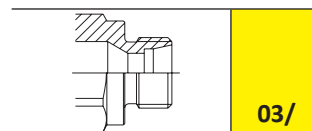
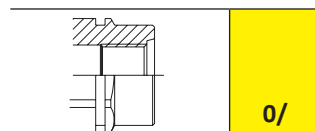
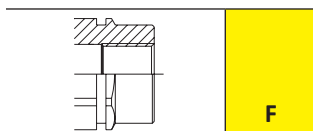

P508

Size					Thread Type					MOBILE
dash	mm	inch	Housing	Number of Couplings	Thread Type	Standard	Thread	Electrical N	Connector Type	Part Number
08	12.5	1/2"	4	4	71/ BSPP	JIS B 2351-1	BSPP 1/2 FEMALE ORB			3P508-4-71/12G M C
08	12.5	1/2"	4	4	F BSPP	ISO 1179-1	BSPP 1/2" FEMALE			3P508-4-F M C*
08	12.5	1/2"	4	4	03/ METRIC	ISO 8434-1-S	M24x1.5 MALE 16S			3P508-4-3/24M C
08	12.5	1/2"	4	4	0/ SAE	ISO 11926-1	3/4" - 16 UNF FEMALE ORB			3P508-4-12S M C
08	12.5	1/2"	4	3	F BSPP	ISO 1179-1	BSPP 1/2" FEMALE			3P508-3-12GMATC
08	12.5	1/2"	4	2	F BSPP	ISO 1179-1	BSPP 1/2" FEMALE			3P508-2-12G M C
08	12.5	1/2"	4	3	F BSPP	ISO 1179-1	BSPP 1/2" FEMALE			3P508-1-3-12GMC
08	12.5	1/2"	4	4	0/ SAE	ISO 11926-1	1 - 1/16" - 12 UN FEMALE ORB	1	3 PINS	2P508-4-34S M C
08	12.5	1/2"	4	4	03/ METRIC	ISO 8434-1-S	M24x1.5 MALE 16S			2P508-4-3/24M C
08	12.5	1/2"	4	4	0/ SAE	ISO 11926-1	3/4" - 16 UNF FEMALE ORB			2P508-4-12S M C
08	12.5	1/2"	4	4	F NPTF	ANSI B1.20.3	NPTF 1/2" FEMALE			2P508-4-12N M C
08	12.5	1/2"	4	3	0/ SAE	ISO 11926-1	3/4" - 16 UNF FEMALE ORB			2P508-3-12S M C
08	12.5	1/2"	4	2	0/ SAE	ISO 11926-1	3/4"-16 UNF FEMALE ORB			2P508-1-2-12SMC
08	12.5	1/2"	4	2	0/ SAE	ISO 11926-1	3/4"-16 UNF FEMALE ORB	1	3 PINS	2P508-1-2-12SFC
08	12.5	1/2"	4	2	F BSPP	ISO 1179-1	BSPP 1/2" FEMALE			2P508-1-2-12GMC
08	12.5	1/2"	4	2	F BSPP	ISO 1179-1	BSPP 1/2" FEMALE	1	3 PINS	3P508-2-12G MHY
08	12.5	1/2"	4	4	F BSPP	ISO 1179-1	BSPP 1/2" FEMALE			2P508-4-12G M C
08	12.5	1/2"	4	4	F BSPP	ISO 1179-1	BSPP 1/2" FEMALE			3P508-4-12G M C

* 1 coupling in stainless steel with seals in FKM. 3 couplings in steel with seals in NBR - PUR.

Spare Parts & Accessories

Female Half				Male Half					
Plates	Lever	Dust cover	Safety Lock	Plates	Seals male	Screws	Plugs	Guiding pins	Docking
KIT P508 F L	KIT LP508	KIT TA P5	KIT SP5 S	KIT P508 M	SK MF 12	KIT VP8	KIT TSP 38 M	KIT GP4	S P5

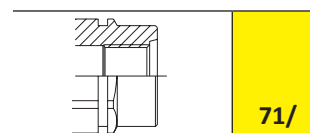
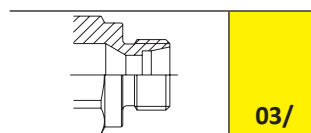
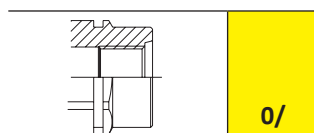
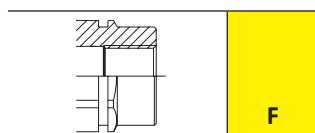



MF MultiGrease

MultiFaster with a special coupling for central lubrication systems and an electrical connector included.

Applications

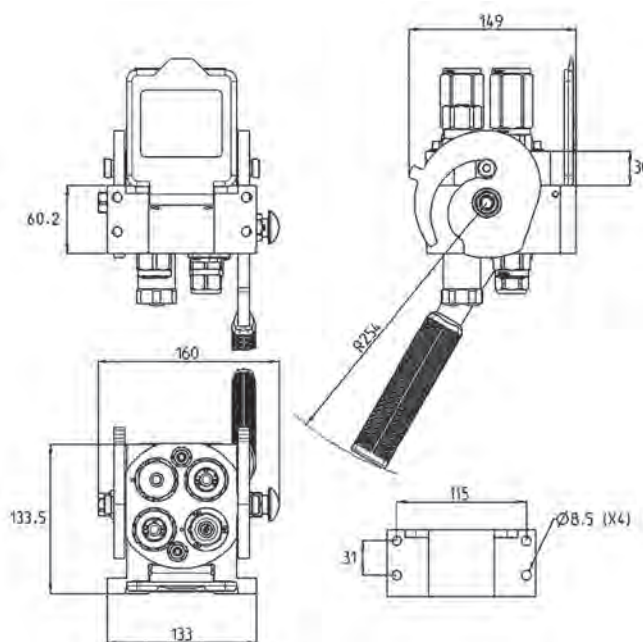

Technical Specifications

dash	Size		Working Pressure (MPa)	Flow Rate (l/min)	Spillage (ml)	Burst pressure (MPa)		
	mm	inch				Male	Female	Male + Female
08	12.5	1/2"	25	70	0.01	100	100	110

Material	Aluminium; Steel
Seals	NBR; PUR
Working temperatures	- 25 °C to + 100 °C
Surface treatment	MATE 500 (CrIII); Paint

Valve Type	Flat
Connection	Lever
Disconnection	Lever
Connection Under Pressure	Allowed Residual



MultiGrease

Size					Thread Type					FIXED
dash	mm	inch	Housing	Number of Couplings	Thread Type	Standard	Thread	Electrical Connector N	Connector Type	Part Number
08	13	1/2"	4	2	F BSPP	ISO 1179-1	BSPP 1/2" FEMALE			3P508-A-2-1-A FC OIL GREASE
08	13	1/2"	4	1	F BSPP	ISO 1179-1	BSPP 1/8" FEMALE			
08	13	1/2"	4	1	F BSPP	ISO 1179-1	BSPP 1/8" FEMALE			
08	13	1/2"	4					1	7 PINS	

Size					Thread Type					MOBILE
dash	mm	inch	Housing	Number of Couplings	Thread Type	Standard	Thread	Electrical Connector N	Connector Type	Part Number
08	13	1/2"	4	2	F BSPP	ISO 1179-1	BSPP 1/2" FEMALE			3P508-A-3-A MC OIL GREASE
08	13	1/2"	4	1	F BSPP	ISO 1179-1	BSPP 1/8" FEMALE			
08	13	1/2"	4					1	7 PINS	

Spare Parts & Accessories

Female Half				Male Half					
Plates	Lever	Dust cover	Safety Lock	Plates	Seals male	Screws	Plugs	Guiding pins	Docking
					SK MF 12		KIT TSP 38 M		

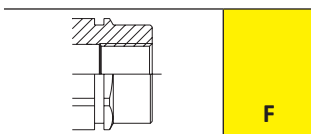



MF P510

MultiFaster 4 lines, 2 lines size 08, 2 lines size 12.

Applications

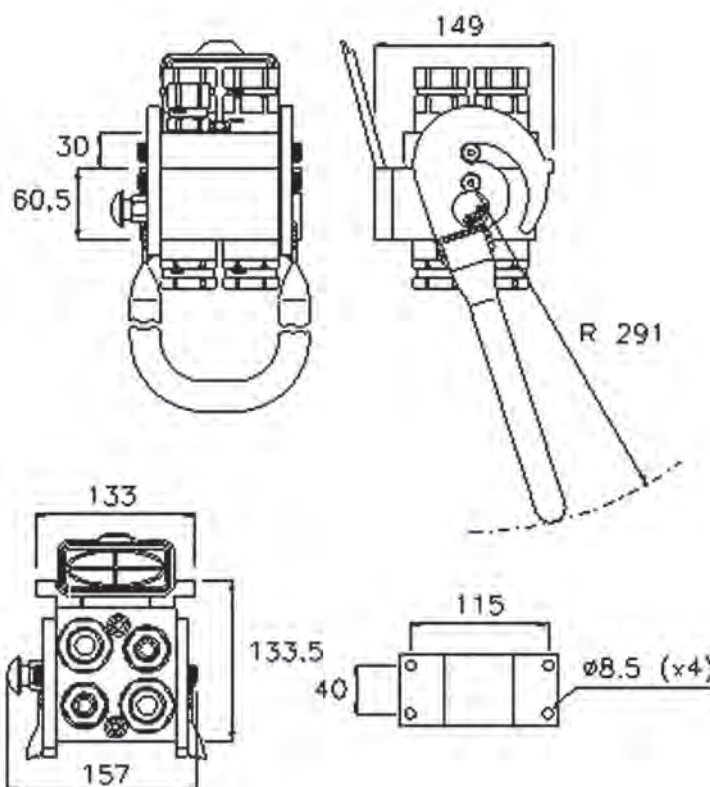

Technical Specifications

dash	Size		Working Pressure (MPa)	Flow Rate (l/min)	Spillage (ml)	Burst pressure (MPa)		
	mm	inch				Male	Female	Male + Female
08	12.5	1/2"	25	70	0.01	100	100	100
12	20	3/4"	25	105	0.02	100	100	100

Material	Aluminium; Steel
Seals	NBR; PUR
Working temperatures	- 25 °C to + 100 °C
Surface treatment	MATE 500 (CrIII); Paint

Valve Type	Flat
Connection	Lever
Disconnection	Lever
Connection Under Pressure	Allowed Residual



P510

Size					Thread Type					FIXED
dash	mm	inch	Housing	Number of Couplings	Thread Type	Standard	Thread	Electrical Connector N	Connector Type	Part Number
08	12.5	1/2"	4	2	F BSPP	ISO 1179-1	BSPP 1/2" FEMALE			3P510-4-A F C
12	20	3/4"		2	F BSPP	ISO 1179-1	BSPP 3/4" FEMALE			
08	12.5	1/2"	4	1	F BSPP	ISO 1179-1	BSPP 1/2" FEMALE			3P510-3-A F C
12	20	3/4"		2	F BSPP	ISO 1179-1	BSPP 3/4" FEMALE			
08	12.5	1/2"	4	1	F BSPP	ISO 1179-1	BSPP 1/2" FEMALE			3P510-2-E F C
12	20	3/4"		1	F BSPP	ISO 1179-1	BSPP 3/4" FEMALE			
08	12.5	1/2"	4					1	3 PINS	3P510-1A-2-A FC
08	12.5	1/2"						1	7 PINS	
12	20	3/4"		1	F BSPP	ISO 1179-1	BSPP 1/2" FEMALE			
12	20	3/4"		1	F BSPP	ISO 1179-1	BSPP 3/4" FEMALE			
08	12.5	1/2"	4	1	F BSPP	ISO 1179-1	BSPP 1/2" FEMALE			3P510-1-3-A F C
08	12.5	1/2"						1	3 PINS	
12	20	3/4"		2	F BSPP	ISO 1179-1	BSPP 3/4" FEMALE			
08	12.5	1/2"	4	2	O/ SAE	ISO 11926-1	1 - 1/16" - 12 UN FEMALE ORB			2P510-4-N F C
12	20	3/4"		2	O/ SAE	ISO 11926-1	3/4" - 16 UNF FEMALE ORB			
08	12.5	1/2"	4	1	F BSPP	ISO 1179-1	BSPP 1/2" FEMALE			2P510-3-A F C
12	20	3/4"		2	F BSPP	ISO 1179-1	BSPP 3/4" FEMALE			
08	12.5	1/2"	4	1	F BSPP	ISO 1179-1	BSPP 1/2" FEMALE			2P510-2-A F C
12	20	3/4"		1	F BSPP	ISO 1179-1	BSPP 3/4" FEMALE			
12	20	3/4"	4	2	O/ SAE	ISO 11926-1	1 - 1/16" - 12 UN FEMALE ORB			2P510-2-34S F C
08	12.5	1/2"	4	1	O/ SAE	ISO 11926-1	1 - 1/16" - 12 UN FEMALE ORB			2P510-1-3-I F C
08	12.5	1/2"						1	3 PINS	
12	20	3/4"		2	O/ SAE	ISO 11926-1	3/4" - 16 UNF FEMALE ORB			
08	12.5	1/2"	4	1	F BSPP	ISO 1179-1	BSPP 1/2" FEMALE			2P510-1-3-A1 FC
08	12.5	1/2"						1	3 PINS	
12	20	3/4"		2	F BSPP	ISO 1179-1	BSPP 3/4" FEMALE			
08	12.5	1/2"	4					1	3 PINS	2P510-1-2-34SFC
12	20	3/4"		2	O/ SAE	ISO 11926-1	1 - 1/16" - 12 UN FEMALE ORB			
12	20	3/4"	4	2	F BSPP	ISO 1179-1	BSPP 3/4" FEMALE			3P510-2-34G F C
12	20	3/4"	4	2	F BSPP	ISO 1179-1	BSPP 3/4" FEMALE			2P510-2-34G F C
08	12.5	1/2"	4	2	F BSPP	ISO 1179-1	BSPP 1/2" FEMALE			2P510-4-A F C
12	20	3/4"		2	F BSPP	ISO 1179-1	BSPP 3/4" FEMALE			

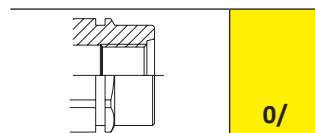
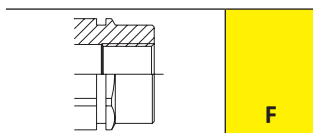

P510

Size					Thread Type					MOBILE
dash	mm	inch	Housing	Number of Couplings	Thread Type	Standard	Thread	Electrical N	Connector Type	Part Number
08	12.5	1/2"	4	1	F BSPP	ISO 1179-1	BSPP 1/2" FEMALE			3P510-3-A M C
12	20	3/4"		2	F BSPP	ISO 1179-1	BSPP 3/4" FEMALE			
08	12.5	1/2"	4	1	F BSPP	ISO 1179-1	BSPP 1/2" FEMALE			3P510-2-E M C
12	20	3/4"		1	F BSPP	ISO 1179-1	BSPP 3/4" FEMALE			
12	20	3/4"	4	2	O/ SAE	ISO 11926-1	1-1/16"-12 UN FEMALE ORB			3P510-2-34S M C
08	12.5	1/2"	4					1	3 PINS	3P510-1A-2-A MC
08	12.5	1/2"						1	7 PINS	
12	20	3/4"		1	F BSPP	ISO 1179-1	BSPP 1/2" FEMALE			
12	20	3/4"		1	F BSPP	ISO 1179-1	BSPP 3/4" FEMALE			
08	12.5	1/2"	4	1	F BSPP	ISO 1179-1	BSPP 1/2" FEMALE			3P510-1-3-A M C
08	12.5	1/2"						1	3 PINS	
12	20	3/4"	4	2	F BSPP	ISO 1179-1	BSPP 3/4" FEMALE			2P510-4-N M C
08	12.5	1/2"		2	O/ SAE	ISO 11926-1	1 - 1/16" - 12 UN FEMALE ORB			
12	20	3/4"	2	O/ SAE	ISO 11926-1	3/4" - 16 UNF FEMALE ORB				
08	12.5	1/2"	4	1	F BSPP	ISO 1179-1	BSPP 1/2" FEMALE			2P510-3-A M C
12	20	3/4"		2	F BSPP	ISO 1179-1	BSPP 3/4" FEMALE			
08	12.5	1/2"	4	1	F BSPP	ISO 1179-1	BSPP 1/2" FEMALE			2P510-2-A M C
12	20	3/4"		1	F BSPP	ISO 1179-1	BSPP 3/4" FEMALE			
12	20	3/4"	4	2	O/ SAE	ISO 11926-1	1 - 1/16" - 12 UN FEMALE ORB			2P510-2-34S M C
08	12.5	1/2"	4	1	O/ SAE	ISO 11926-1	1 - 1/16" - 12 UN FEMALE ORB			2P510-1-3-I M C
08	12.5	1/2"						1	3 PINS	
12	20	3/4"		2	O/ SAE	ISO 11926-1	3/4" - 16 UNF FEMALE ORB			
08	12.5	1/2"	4	1	F BSPP	ISO 1179-1	BSPP 1/2" FEMALE			2P510-1-3-A1 MC
08	12.5	1/2"						1	3 PINS	
12	20	3/4"	2	F BSPP	ISO 1179-1	BSPP 3/4" FEMALE				
08	12.5	1/2"	4	2	F BSPP	ISO 1179-1	BSPP 1/2" FEMALE			3P510-4-A M C
12	20	3/4"		2	F BSPP	ISO 1179-1	BSPP 3/4" FEMALE			
12	20	3/4"	4	2	F BSPP	ISO 1179-1	BSPP 3/4" FEMALE			2P510-2-34G M C
12	20	3/4"	4	2	F BSPP	ISO 1179-1	BSPP 3/4" FEMALE			3P510-2-34G M C
08	12.5	1/2"	4	2	F BSPP	ISO 1179-1	BSPP 1/2" FEMALE			2P510-4-A M C
12	20	3/4"		2	F BSPP	ISO 1179-1	BSPP 3/4" FEMALE			

Spare Parts & Accessories

Female Half				Male Half					
Plates	Lever	Dust cover	Safety Lock	Plates	Seals male	Screws	Plugs	Guiding pins	Docking
KIT P510 F L	KIT LP510		KIT SP5 S	KIT P510 M	SK MF 12	KIT VP8	KIT TSP 38 M	KIT GP4	S P510
	KIT L3P510				SK MF 34		KIT TSP 34 M		

*this kit is only suitable for items of P510 series equipped with a straight lever (3P510...FC), but can't be used to service item with U-shaped lever.





MF PS06

MultiFaster 4 lines, size 06.

MultiFaster suitable for 4 hydraulic lines size 06.

Applications

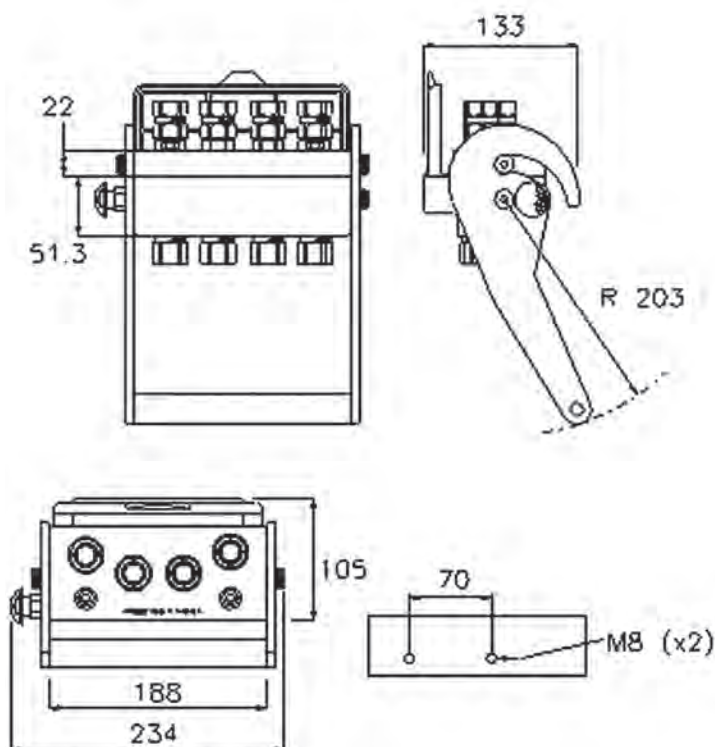

Technical Specifications

dash	Size		Working Pressure (MPa)	Flow Rate (l/min)	Spillage (ml)	Burst pressure (MPa)		
	mm	inch				Male	Female	Male + Female
06	10	3/8"	25	40	0.008	100	100	100

Material	Aluminium; Steel
Seals	NBR; PUR
Working temperatures	- 25 °C to + 100 °C
Surface treatment	MATE 500 (CrIII); Paint

Valve Type	Flat
Connection	Lever
Disconnection	Lever
Connection Under Pressure	Allowed Residual



PS06

Size					Thread Type					FIXED
dash	mm	inch	Housing	Number of Couplings	Thread Type	Standard	Thread	Electrical Connector N	Connector Type	Part Number
06	10	3/8"	4	4	11/ SAE	ISO 8434-3	13/16"-16 UN MALE ORFS			2PS06B-4-B F C
06	10	3/8"	4	4	02/ METRIC	ISO 8434-1-L	M22x1.5 MALE 15L			2PS06B-4-2/2F C
06	10	3/8"	4	4	02/ METRIC	ISO 8434-1-L	M22x1.5 MALE 15L			2PS06B-4-2/22FC
06	10	3/8"	4	4	11/ SAE	ISO 8434-3	13/16"-16 UN MALE ORFS			2PS06A-4-B F C
06	10	3/8"	4	4	F BSPP	ISO 1179-1	BSPP 3/8" FEMALE			2PS06-4-38G F C
06	10	3/8"	4	4	F BSPP	ISO 1179-1	BSPP 1/2" FEMALE			2PS06-4-12G F C
06	10	3/8"	4	4	02/ METRIC	ISO 8434-1-L	M22x1.5 MALE 15L			2PS06-4-2/22F C

Size					Thread Type					MOBILE
dash	mm	inch	Housing	Number of Couplings	Thread Type	Standard	Thread	Electrical Connector N	Connector Type	Part Number
06	10	3/8"	4	4	F BSPP	ISO 1179-1	BSPP 3/8" FEMALE			2PS06-4-38G M C
06	10	3/8"	4	4	20/ BSPP	ISO 8434-6	BSPP 1/2" FEMALE SWIVEL NUT			2PS06-4-20/12MC
06	10	3/8"	4	4	16/ BSPP	ISO 1179-1	BSPP 3/8" FEMALE			2PS06-4-16/3GMC
06	10	3/8"	4	4	11/ SAE	ISO 8434-3	13/16"-16 UN MALE ORFS			2PS06-4-11/FSMC
06	10	3/8"	4	2	02/ METRIC	ISO 8434-1-L	M22x1,5 MALE 15L			2PS06-2-2/22M C
06	10	3/8"	4	4	F BSPP	ISO 1179-1	BSPP 1/2" FEMALE			2PS06-4-12G M C
06	10	3/8"	4	4	02/ METRIC	ISO 8434-1-L	M22x1,5 MALE 15L			2PS06-4-2/22M C

Spare Parts & Accessories

Female Half				Male Half					
Plates	Lever	Dust cover	Safety Lock	Plates	Seals male	Screws	Plugs	Guiding pins	Docking
KIT PS06 F L	KIT LP606	KIT TA P6	KIT SP5 S	KIT PS06 M	SK MF 38	KIT VP4	KIT TSP 12 M	KIT GP4	S PS

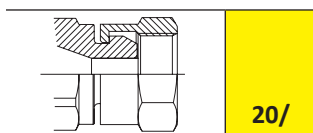
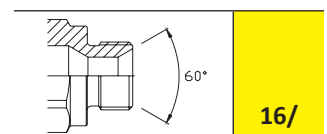
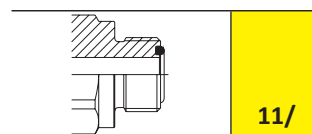
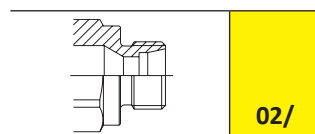
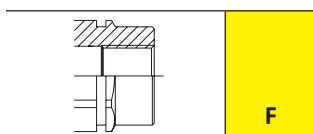



MF PS06-x

MultiFaster 5 lines, 4 lines size 06, 1 line size 08.

MultiFaster suitable for 4 lines size 06+1 line size 08.
The additional line could be either an electrical connector or an hydraulic coupling.

Applications

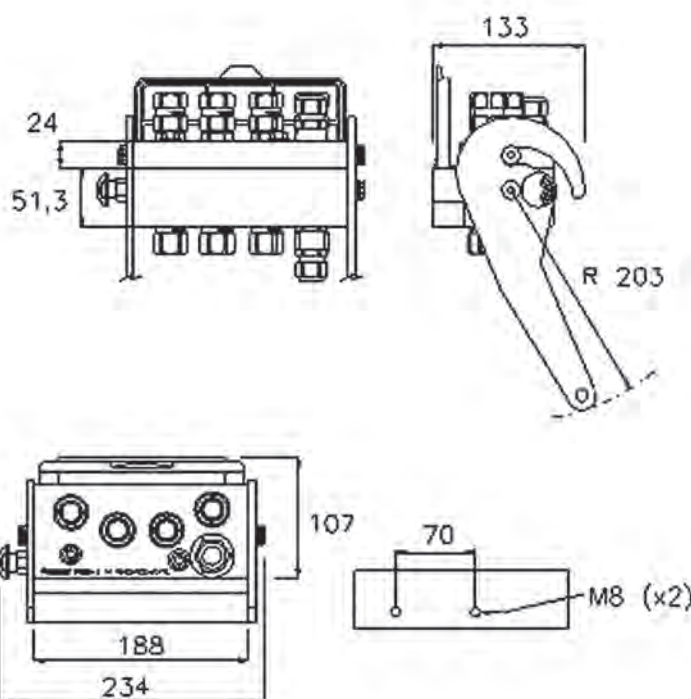

Technical Specifications

dash	Size		Working Pressure (MPa)	Flow Rate (l/min)	Spillage (ml)	Burst pressure (MPa)		
	mm	inch				Male	Female	Male + Female
06	10	3/8"	25	40	8	100	100	100
08	12.5	1/2"	25	70	0.01	100	100	100

Material	Aluminium; Steel
Seals	NBR; PUR
Working temperatures	- 25 °C to + 100 °C
Surface treatment	MATE 500 (CrIII); Paint

Valve Type	Flat
Connection	Lever
Disconnection	Lever
Connection Under Pressure	Allowed Residual



PS06-x

Size					Thread Type					FIXED
dash	mm	inch	Housing	Number of Couplings	Thread Type	Standard	Thread	Electrical Connector N	Connector Type	Part Number
06	10	3/8"	5	4	02/ METRIC	ISO 8434-1-L	M22x1.5 MALE 15L	1	7 PINS	2PS06-A-4-2/2FC
08	12.5	1/2"								
06	10	3/8"	5	4	F BSPP	ISO 1179-1	BSPP 3/8" FEMALE	1	3 PINS	2PS06-1-4-38GFC
08	12.5	1/2"								
06	10	3/8"	5	4	F BSPP	ISO 1179-1	BSPP 1/2" FEMALE	1	3 PINS	2PS06-1-4-12GFC
08	12.5	1/2"								
06	10	3/8"	5	4	02/ METRIC	ISO 8434-1-L	M22x1.5 MALE 15L	1	3 PINS	2PS06-1-4-2/2FC
08	12.5	1/2"								

Size					Thread Type					MOBILE
dash	mm	inch	Housing	Number of Couplings	Thread Type	Standard	Thread	Electrical Connector N	Connector Type	Part Number
06	10	3/8"	5	4	20/ BSPP	ISO 8434-6	"BSPP 1/2"" FEMALE SWIVEL NUT	1	7 PINS	2PS06-A-4-CMC
08	12.5	1/2"								
06	10	3/8"	5	4	F BSPP	ISO 1179-1	BSPP 3/8" FEMALE	1	3 PINS	2PS06-1-4-38GMC
08	12.5	1/2"								
06	10	3/8"	5	4	0/ SAE	ISO 11926-1	3/4" - 16 UNF FEMALE ORB	1	3 PINS	2PS06-1-4-12SMC
08	12.5	1/2"								
06	10	3/8"	5	4	F BSPP	ISO 1179-1	BSPP 1/2" FEMALE	1	3 PINS	2PS06-1-4-12GMC
08	12.5	1/2"								
06	10	3/8"	5	4	02/ METRIC	ISO 8434-1-L	M22x1.5 MALE 15L	1	3 PINS	2PS06-0-4-2/2MC
06	10	3/8"								
08	12.5	1/2"	5	4	02/ METRIC	ISO 8434-1-L	M22x1.5 MALE 15L	1	3 PINS	2PS06-1-4-2/2MC
08	12.5	1/2"								

Spare Parts & Accessories

Female Half				Male Half					
Plates	Lever	Dust cover	Safety Lock	Plates	Seals male	Screws	Plugs	Guiding pins	Docking
				KIT PS06-0 M	SK MF 38		KIT TSP 38 M		
					SK MF 12		KIT TSP 12 M		





MF PSA06

MultiFaster 4 lines, size 06. Possible to connect single lines.

MultiFaster 4 lines size 06. Thanks to the special configuration, it is possible to connect the fixed half to single lines (ISO 16028) instead of mobile half. Interchangeable with standard MultiFaster PSO6.



Applications

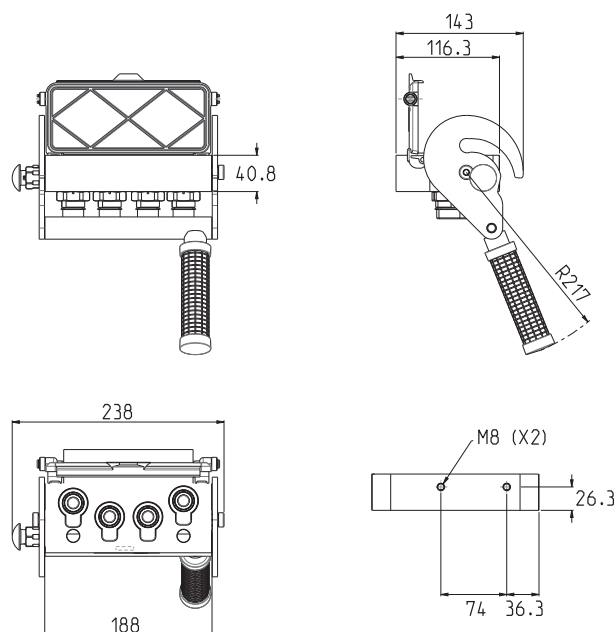

Technical Specifications

dash	Size		Working Pressure (MPa)	Flow Rate (l/min)	Spillage (ml)	Burst pressure (MPa)		
	mm	inch				Male	Female	Male + Female
06	10	3/8"	25	40	0.008	100	100	100

Material	Aluminium; Steel
Seals	NBR; PUR
Working temperatures	- 25 °C to + 100 °C
Surface treatment	MATE 500 (CrIII); Paint

Valve Type	Flat
Connection	Lever
Disconnection	Lever
Connection Under Pressure	Allowed Residual



PSA06

Size					Thread Type					FIXED
dash	mm	inch	Housing	Number of Couplings	Thread Type	Standard	Thread	Electrical Connector N	Connector Type	Part Number
06	10	3/8"	4	4	02/ METRIC	ISO 8434-1-L	M22x1.5 MALE 15L			2PSA06-4-2/22FC

Size					Thread Type					MOBILE
dash	mm	inch	Housing	Number of Couplings	Thread Type	Standard	Thread	Electrical Connector N	Connector Type	Part Number
06	10	3/8"	4	4	F BSPP	ISO 1179-1	BSPP 3/8" FEMALE			2PS06-4-38G M C
06	10	3/8"	4	4	20/ BSPP	ISO 8434-6	BSPP 1/2" FEMALE SWIVEL NUT			2PS06-4-20/12MC
06	10	3/8"	4	4	16/ BSPP	ISO 1179-1	BSPP 3/8" FEMALE			2PS06-4-16/3GMC
06	10	3/8"	4	4	11/ SAE	ISO 8434-3	13/16"-16 UN MALE ORFS			2PS06-4-11/FSMC
06	10	3/8"	4	2	02/ METRIC	ISO 8434-1-L	M22x1,5 MALE 15L			2PS06-2-2/22M C
06	10	3/8"	4	4	F BSPP	ISO 1179-1	BSPP 1/2" FEMALE			2PS06-4-12G M C
06	10	3/8"	4	4	02/ METRIC	ISO 8434-1-L	M22x1,5 MALE 15L			2PS06-4-2/22M C

Spare Parts & Accessories

Female Half				Male Half					
Plates	Lever	Dust cover	Safety Lock	Plates	Seals male	Screws	Plugs	Guiding pins	Docking
					SK MF 38	KIT VP4	KIT TSP 12 M		

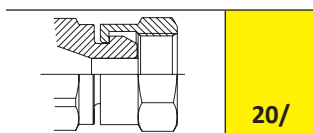
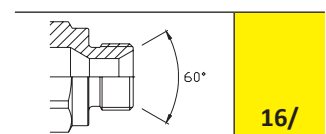
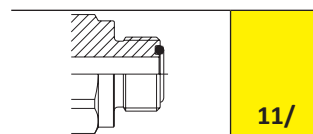
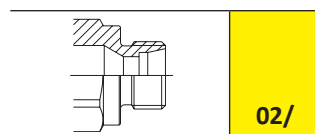
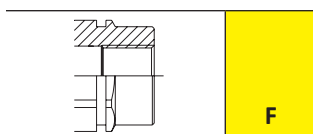



MF PS08

MultiFaster 5 lines, 4 lines size 08, 1 line with electrical connector.

MultiFaster suitable for 4+1 lines size 08. The additional line could be either an electrical connector or an hydraulic coupling.

Applications

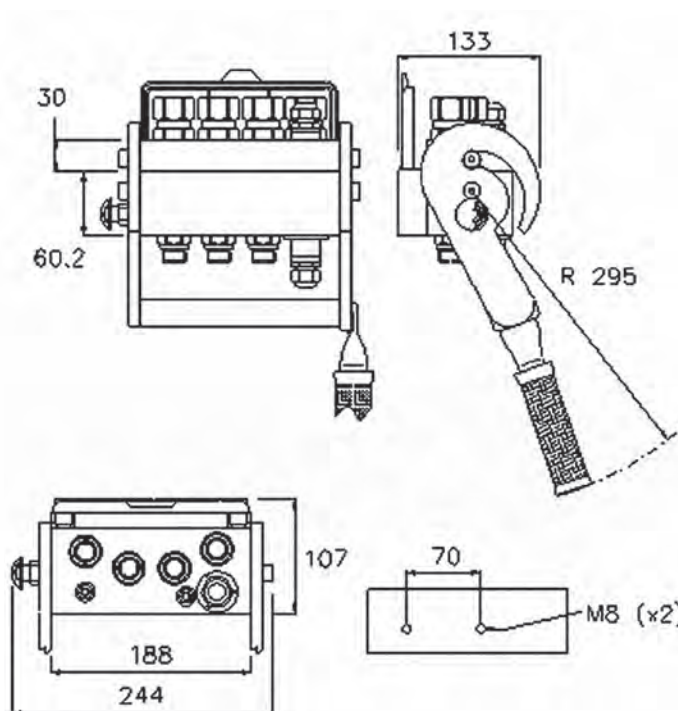

Technical Specifications

dash	Size		Working Pressure (MPa)	Flow Rate (l/min)	Spillage (ml)	Burst pressure (MPa)		
	mm	inch				Male	Female	Male + Female
08	12.5	1/2"	25	70	0.01	100	100	100

Material	Aluminium; Steel
Seals	NBR; PUR
Working temperatures	- 25 °C to + 100 °C
Surface treatment	MATE 500 (CrIII); Paint

Valve Type	Flat
Connection	Lever
Disconnection	Lever
Connection Under Pressure	Allowed Residual



PS08

Size					Thread Type					FIXED
dash	mm	inch	Housing	Number of Couplings	Thread Type	Standard	Thread	Electrical Connector N	Connector Type	Part Number
08	12.5	1/2"	5	4	02/ METRIC	ISO 8434-1-L	M22x1.5 MALE 15L			2PS08-4-2/22F C
08	12.5	1/2"	5	4	02/ METRIC	ISO 8434-1-L	M22x1.5 MALE 15L			2PS08-1-4-2/2FC
08	12.5	1/2"						1	3 PINS	
08	12.5	1/2"	5	4	F BSPP	ISO 1179-1	BSPP 1/2" FEMALE			2PS08-1-4-12GFC
08	12.5	1/2"						1	3 PINS	

Size					Thread Type					MOBILE
dash	mm	inch	Housing	Number of Couplings	Thread Type	Standard	Thread	Electrical Connector N	Connector Type	Part Number
08	12.5	1/2"	5	4	02/ METRIC	ISO 8434-1-L	M22x1.5 MALE 15L			2PS08-4-2/22M C
08	12.5	1/2"	5	4	02/ METRIC	ISO 8434-1-L	M22x1.5 MALE 15L			2PS08-1-4-2/2MC
08	12.5	1/2"						1	3 PINS	
08	12.5	1/2"	5	4	F BSPP	ISO 1179-1	BSPP 1/2" FEMALE			2PS08-1-4-12GMC
08	12.5	1/2"						1	3 PINS	

Spare Parts & Accessories

Female Half				Male Half					
Plates	Lever	Dust cover	Safety Lock	Plates	Seals male	Screws	Plugs	Guiding pins	Docking
KIT PS08 F L		KIT TA P6	KIT SP5 S	KIT PS08 M	SK MF 12	KIT VP8	KIT TSP 38 M	KIT GP4	

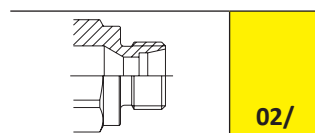
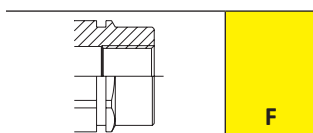



MF P5066

MultiFaster 6 lines, size 06.

Applications

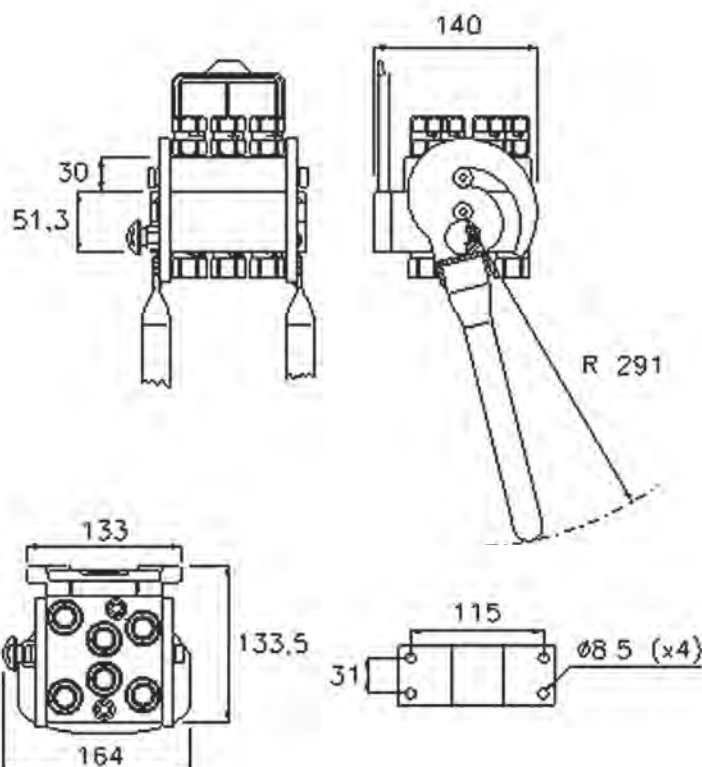

Technical Specifications

dash	Size		Working Pressure (MPa)	Flow Rate (l/min)	Spillage (ml)	Burst pressure (MPa)		
	mm	inch				Male	Female	Male + Female
06	10	3/8"	25	40	0.008	100	100	100

Material	Aluminium; Steel
Seals	NBR; PUR
Working temperatures	- 25 °C to + 100 °C
Surface treatment	MATE 500 (CrIII); Paint

Valve Type	Flat
Connection	Lever
Disconnection	Lever
Connection Under Pressure	Allowed Residual



P5066

Size					Thread Type					FIXED
dash	mm	inch	Housing	Number of Couplings	Thread Type	Standard	Thread	Electrical Connector N	Connector Type	Part Number
06	10	3/8"	6	6	F BSPP	ISO 1179-1	BSPP 3/8" FEMALE			2P5066-6-38G FC

Size					Thread Type					MOBILE
dash	mm	inch	Housing	Number of Couplings	Thread Type	Standard	Thread	Electrical Connector N	Connector Type	Part Number
06	10	3/8"	6	6	F BSPP	ISO 1179-1	BSPP 3/8" FEMALE			3P5066-6-38G MC
06	10	3/8"	6	6	F BSPP	ISO 1179-1	BSPP 3/8" FEMALE			2P5066-6-38G MC

Spare Parts & Accessories

Female Half				Male Half					
Plates	Lever	Dust cover	Safety Lock	Plates	Seals male	Screws	Plugs	Guiding pins	Docking
		KIT TA P5	KIT SP5 S		SK MF 38		KIT TSP 12 M	KIT GP4	

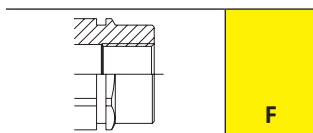

MF P606



MultiFaster 6 lines, size 06.

Applications

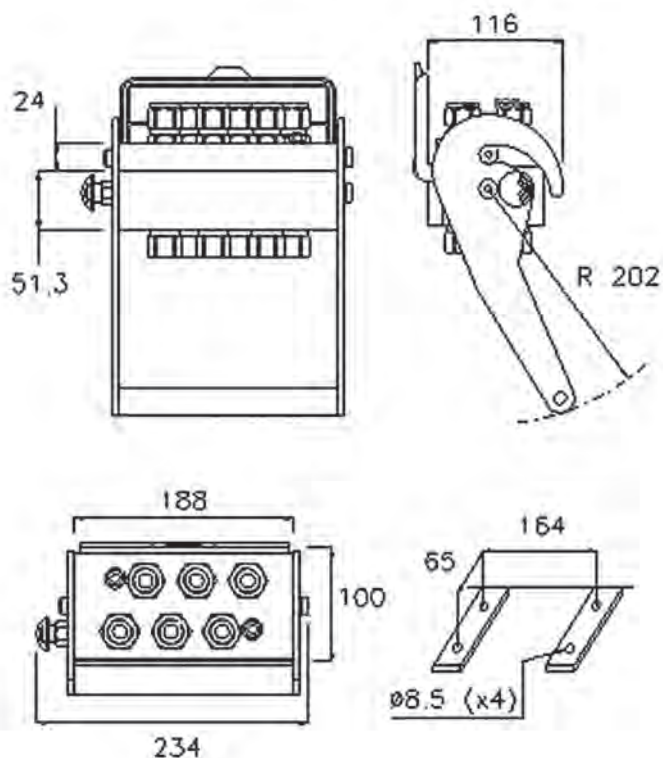

Technical Specifications

dash	Size		Working Pressure (MPa)	Flow Rate (l/min)	Spillage (ml)	Burst pressure (MPa)		
	mm	inch				Male	Female	Male + Female
06	10	3/8"	25	40	0.008	100	100	100

Material	Aluminium; Steel
Seals	NBR; PUR
Working temperatures	- 25 °C to + 100 °C
Surface treatment	MATE 500 (CrIII); Paint

Valve Type	Flat
Connection	Lever
Disconnection	Lever
Connection Under Pressure	Allowed Residual



P606

Size					Thread Type					FIXED
dash	mm	inch	Housing	Number of Couplings	Thread Type	Standard	Thread	Electrical Connector N	Connector Type	Part Number
06	10	3/8"	6	6	F BSPP	ISO 1179-1	BSPP 3/8" FEMALE			2P606-6-38G F C
06	10	3/8"	6	6	O2/ METRIC	ISO 8434-1-L	M22x1.5 MALE 15L			2P606-6-2/22F C
06	10	3/8"	6	6	O/ SAE	ISO 11926-1	3/4" - 16 UNF FEMALE ORB			2P606-6-12S F C
06	10	3/8"	6	6	F BSPP	ISO 1179-1	BSPP 1/2" FEMALE			2P606-6-12G F C

Size					Thread Type					MOBILE
dash	mm	inch	Housing	Number of Couplings	Thread Type	Standard	Thread	Electrical Connector N	Connector Type	Part Number
06	10	3/8"	6	6	F BSPP	ISO 1179-1	BSPP 3/8" FEMALE			2P606-6-38G M C
06	10	3/8"	6	6	O2/ METRIC	ISO 8434-1-L	M22x1.5 MALE 15L			2P606-6-2/22M C
06	10	3/8"	6	6	O/ SAE	ISO 11926-1	3/4" - 16 UNF FEMALE ORB			2P606-6-12S M C
06	10	3/8"	6	6	F BSPP	ISO 1179-1	BSPP 1/2" FEMALE			2P606-6-12G M C

Spare Parts & Accessories

Female Half				Male Half					
Plates	Lever	Dust cover	Safety Lock	Plates	Seals male	Screws	Plugs	Guiding pins	Docking
KIT P606 F L	KIT LP606	KIT TA P6	KIT SP5 S	KIT P606 M	SK MF 38	KIT VP4	KIT TSP 12 M	KIT GP4	S P6

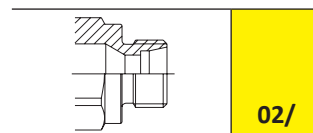
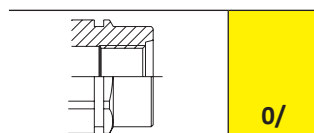
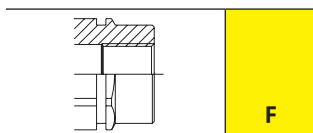



MF P608

MultiFaster 6 lines, size 08.

Applications

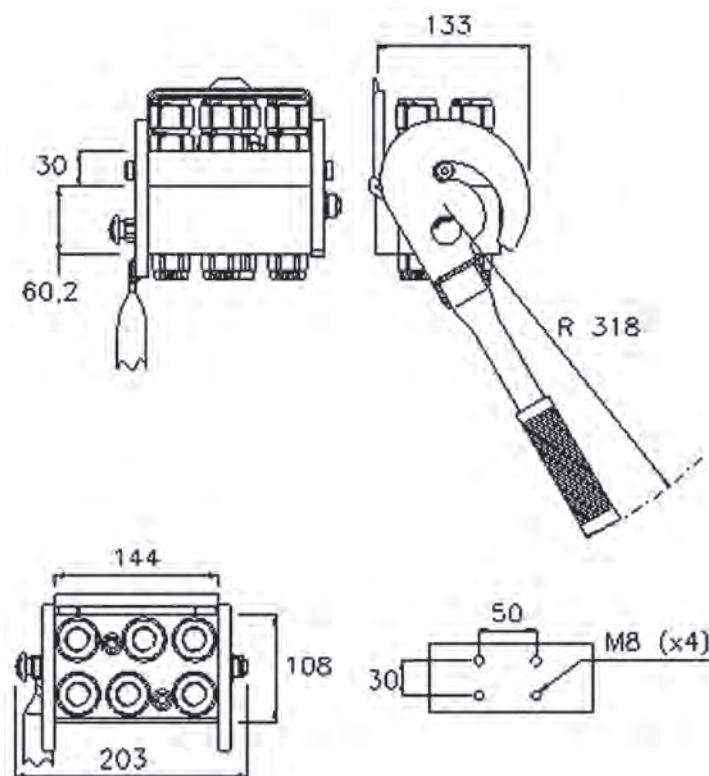

Technical Specifications

dash	Size		Working Pressure (MPa)	Flow Rate (l/min)	Spillage (ml)	Burst pressure (MPa)		
	mm	inch				Male	Female	Male + Female
08	12.5	1/2"	25	70	0.01	100	100	100

Material	Aluminium; Steel
Seals	NBR; PUR
Working temperatures	- 25 °C to + 100 °C
Surface treatment	MATE 500 (CrIII); Paint

Valve Type	Flat
Connection	Lever
Disconnection	Lever
Connection Under Pressure	Allowed Residual



P608

Size					Thread Type					FIXED
dash	mm	inch	Housing	Number of Couplings	Thread Type	Standard	Thread	Electrical N	Connector Type	Part Number
08	12.5	1/2"	6	6	F BSPP	ISO 1179-1	BSPP 1/2" FEMALE			3P608-6-12G F C
08	12.5	1/2"	6	4	F BSPP	ISO 1179-1	BSPP 1/2" FEMALE			2P608-B-4-C F C
08	12.5	1/2"						2	7 PINS	
08	12.5	1/2"	6	5	F BSPP	ISO 1179-1	BSPP 1/2" FEMALE			2P608-A-5-12G F C
08	12.5	1/2"						1	7 PINS	
08	12.5	1/2"	6	6	O/ SAE	ISO 11926-1	1 - 1/16" - 12 UN FEMALE ORB			2P608-6-34S F C
08	12.5	1/2"	6	6	O/ SAE	ISO 11926-1	3/4" - 16 UNF FEMALE ORB			2P608-6-12S F C
08	12.5	1/2"	6	4	O/ SAE	ISO 11926-1	3/4" - 16 UNF FEMALE ORB			2P608-4-12S F C
08	12.5	1/2"	6	4	F BSPP	ISO 1179-1	BSPP 1/2" FEMALE			2P608-2-4-12G F C
08	12.5	1/2"						2	3 PINS	
08	12.5	1/2"	6	5	F BSPP	ISO 1179-1	BSPP 1/2" FEMALE			2P608-1-5-12G F C
08	12.5	1/2"						1	3 PINS	
08	12.5	1/2"	6	6	F BSPP	ISO 1179-1	BSPP 1/2" FEMALE			2P608-6-12G F C

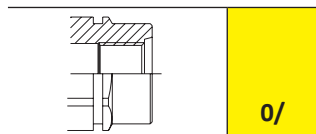
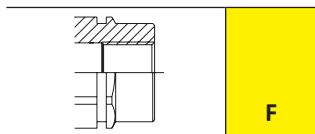

P608

Size					Thread Type					MOBILE
dash	mm	inch	Housing	Number of Couplings	Thread Type	Standard	Thread	Electrical N	Connector Type	Part Number
08	12.5	1/2"	6	4	F BSPP	ISO 1179-1	BSPP 1/2" FEMALE			3P608-B-4-12G M C
08	12.5	1/2"						2	7 PINS	
08	12.5	1/2"	6	5	F BSPP	ISO 1179-1	BSPP 1/2" FEMALE			3P608-A-5-12G M C
08	12.5	1/2"						1	7 PINS	
08	12.5	1/2"	6	6	F BSPP	ISO 1179-1	BSPP 1/2" FEMALE			3P608-6-12G M C
08	12.5	1/2"	6	5	F BSPP	ISO 1179-1	BSPP 1/2" FEMALE			3P608-1-5-12G M C
08	12.5	1/2"						1	3 PINS	
08	12.5	1/2"	6	6	11/ SAE	ISO 8434-3	13/16"-16 UN MALE ORFS			2P608-6-8BC M C
08	12.5	1/2"	6	6	11/ SAE	ISO 8434-3	13/16"-16 UN MALE ORFS			2P608-6-8B M C
08	12.5	1/2"	6	6	0/ SAE	ISO 11926-1	1 - 1/16" - 12 UN FEMALE ORB			2P608-6-34S M C
08	12.5	1/2"	6	6	13/ SAE	ISO 8434-2	3/4"-16 UNF MALE JIC			2P608-6-13/FS M C
08	12.5	1/2"	6	6	0/ SAE	ISO 11926-1	3/4" - 16 UNF FEMALE ORB			2P608-6-12S M C
08	12.5	1/2"	6	5	F BSPP	ISO 1179-1	BSPP 1/2" FEMALE			2P608-5-12G M C
08	12.5	1/2"	6	4	11/ SAE	ISO 8434-3	13/16"-16 UN MALE ORFS			2P608-4-H M C
08	12.5	1/2"	6	4	11/ SAE	ISO 8434-3	13/16"-16 UN MALE ORFS			2P608-4-8BC M C
08	12.5	1/2"	6	4	11/ SAE	ISO 8434-3	13/16"-16 UN MALE ORFS			2P608-4-8B M C
08	12.5	1/2"	6	4	0/ SAE	ISO 11926-1	3/4" - 16 UNF FEMALE ORB			2P608-4-12S M C
08	12.5	1/2"	6	4	11/ SAE	ISO 8434-3	1"-14 UNS MALE ORFS			2P608-4-11/GS M C
08	12.5	1/2"	6	4	F BSPP	ISO 1179-1	BSPP 1/2" FEMALE			2P608-2-4-12G M C
08	12.5	1/2"						2	3 PINS	
08	12.5	1/2"	6	6	F BSPP	ISO 1179-1	BSPP 1/2" FEMALE			2P608-6-12G M C

Spare Parts & Accessories

Female Half				Male Half					
Plates	Lever	Dust cover	Safety Lock	Plates	Seals male	Screws	Plugs	Guiding pins	Docking
KIT P608 F L	KIT LP608	KIT TA P608	KIT SP5 S	KIT P608 M	SK MF 12	KIT VP8	KIT TSP 38 M	KIT GP4	S P608





MF P5068

MultiFaster 8 lines, size 06.

Applications

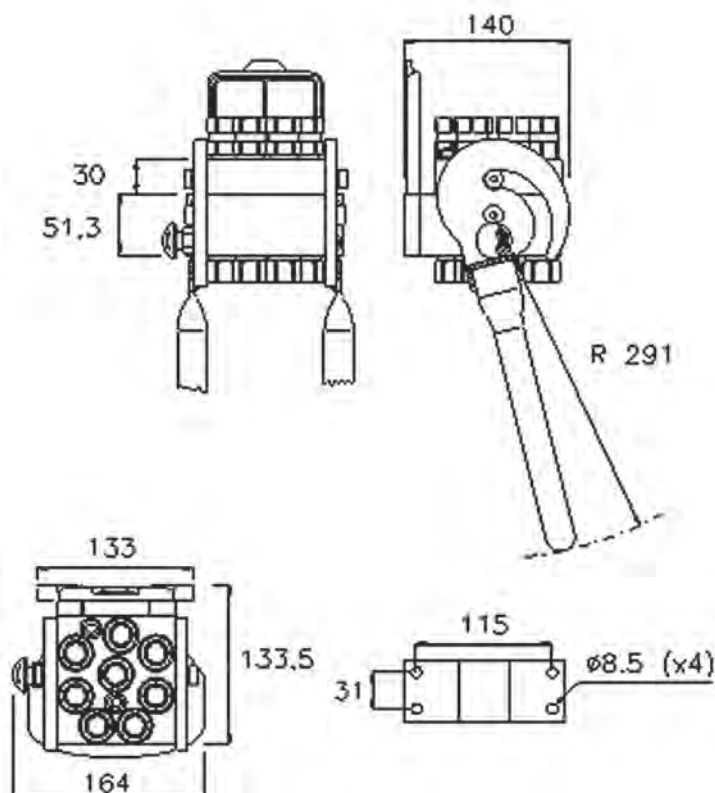

Technical Specifications

dash	Size		Working Pressure (MPa)	Flow Rate (l/min)	Spillage (ml)	Burst pressure (MPa)		
	mm	inch				Male	Female	Male + Female
06	10	3/8"	25	40	0.008	100	100	100

Material	Aluminium; Steel
Seals	NBR; PUR
Working temperatures	- 25 °C to + 100 °C
Surface treatment	MATE 500 (CrIII); Paint

Valve Type	Flat
Connection	Lever
Disconnection	Lever
Connection Under Pressure	Allowed Residual



P5068

Size					Thread Type					FIXED
dash	mm	inch	Housing	Number of Couplings	Thread Type	Standard	Thread	Electrical Connector N	Connector Type	Part Number
06	10	3/8"	8	8	13/ SAE	ISO 8434-2	3/4"-16 UNF FEMALE ORB			2P5068-8-C F C
06	10	3/8"	8	8	F BSPP	ISO 1179-1	BSPP 3/8" FEMALE			2P5068-8-38GF C
06	10	3/8"	8	8	F BSPP	ISO 1179-1	BSPP 1/2" FEMALE			2P5068-8-12GF C

Size					Thread Type					MOBILE
dash	mm	inch	Housing	Number of Couplings	Thread Type	Standard	Thread	Electrical Connector N	Connector Type	Part Number
06	10	3/8"	8	8	13/ SAE	ISO 8434-2	3/4"-16 UNF MALE			2P5068-8-D M C
06	10	3/8"	8	8	F BSPP	ISO 1179-1	BSPP 3/8" FEMALE			2P5068-8-38GM C
06	10	3/8"	8	8	F BSPP	ISO 1179-1	BSPP 1/2" FEMALE			3P5068-8-12G MC

Spare Parts & Accessories

Female Half				Male Half					
Plates	Lever	Dust cover	Safety Lock	Plates	Seals male	Screws	Plugs	Guiding pins	Docking
KIT P5068 F L		KIT TA P5	KIT SP4	KIT P5068 M	SK MF 38		KIT TSP 12 M	KIT GP4	S P5068





MF P808

MultiFaster 8 lines, size 08.

Applications

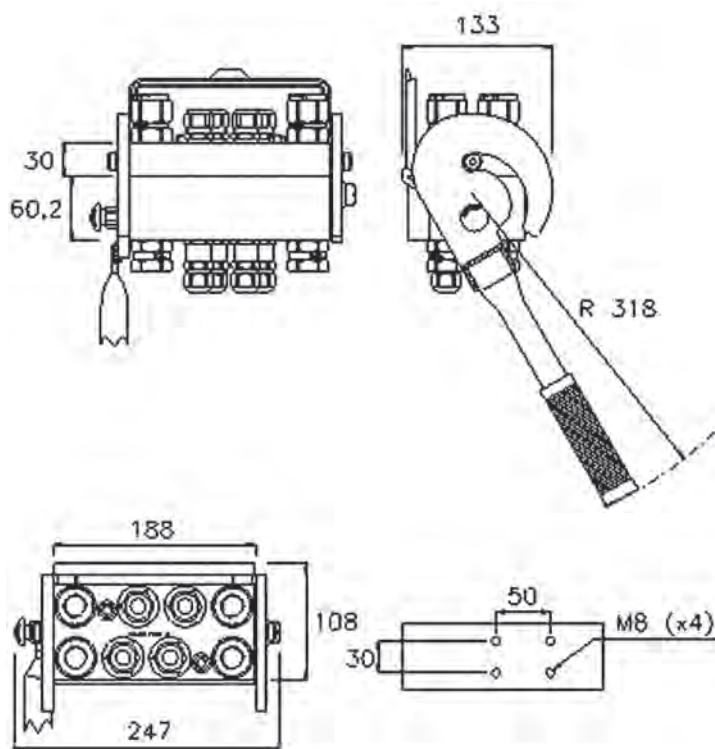

Technical Specifications

dash	Size		Working Pressure (MPa)	Flow Rate (l/min)	Spillage (ml)	Burst pressure (MPa)		
	mm	inch				Male	Female	Male + Female
08	12.5	1/2"	25	70	0.01	100	100	100

Material	Aluminium; Steel
Seals	NBR; PUR
Working temperatures	- 25 °C to + 100 °C
Surface treatment	MATE 500 (CrIII); Paint

Valve Type	Flat
Connection	Lever
Disconnection	Lever
Connection Under Pressure	Allowed Residual



P808

Size					Thread Type					FIXED
dash	mm	inch	Housing	Number of Couplings	Thread Type	Standard	Thread	Electrical Connector N	Connector Type	Part Number
08	12.5	1/2"	8	7	F BSPP	ISO 1179-1	BSPP 1/2" FEMALE	1	7 PINS	2P808-A-7-12GFC
08	12.5	1/2"								
08	12.5	1/2"	8	8	O2/ METRIC	ISO 8434-1-L	M16x1.5 MALE 10L			2P808-8-E F C
08	12.5	1/2"	8	8	O/ SAE	ISO 11926-1	3/4"-16 UNF FEMALE ORB			2P808-8-12S FC
08	12.5	1/2"	8	6	F BSPP	ISO 1179-1	BSPP 1/2" FEMALE			2P808-6-12G F C
08	12.5	1/2"	8	8	F BSPP	ISO 1179-1	BSPP 1/2" FEMALE			2P808-8-T F C
08	12.5	1/2"	8	8	F BSPP	ISO 1179-1	BSPP 1/2" FEMALE			2P808-8-12G FC

Size					Thread Type					MOBILE
dash	mm	inch	Housing	Number of Couplings	Thread Type	Standard	Thread	Electrical Connector N	Connector Type	Part Number
08	12.5	1/2"	8	8	O2/ METRIC	ISO 8434-1-L	M16x1.5 MALE 10L			3P808-8-E M C
08	12.5	1/2"	8	7	F BSPP	ISO 1179-1	BSPP 1/2" FEMALE	1	7 PINS	2P808-A-7-12GMC
08	12.5	1/2"								
08	12.5	1/2"	8	8	O/ SAE	ISO 11926-1	1 - 1/16" - 12 UN FEMALE ORB			2P808-8-34S MC
08	12.5	1/2"	8	6	11/ SAE	ISO 8434-3	13/16"-16 UN MALE ORFS			2P808-6-8BC M C
08	12.5	1/2"	8	6	F BSPP	ISO 1179-1	BSPP 1/2" FEMALE			2P808-6-12G M C
08	12.5	1/2"	8	8	F BSPP	ISO 1179-1	BSPP 1/2" FEMALE			3P808-8-12G MC
08	12.5	1/2"	8	8	F BSPP	ISO 1179-1	BSPP 1/2" FEMALE			2P808-8-12G MC

Spare Parts & Accessories

Female Half				Male Half					
Plates	Lever	Dust cover	Safety Lock	Plates	Seals male	Screws	Plugs	Guiding pins	Docking
KIT P808 F L	KIT LP808	KIT TA P8	KIT SP5 S	KIT P808 M	SK MF 12	KIT VP8	KIT TSP 38 M	KIT GP8	





MF P1004

MultiFaster 10 lines, size 04.

Applications

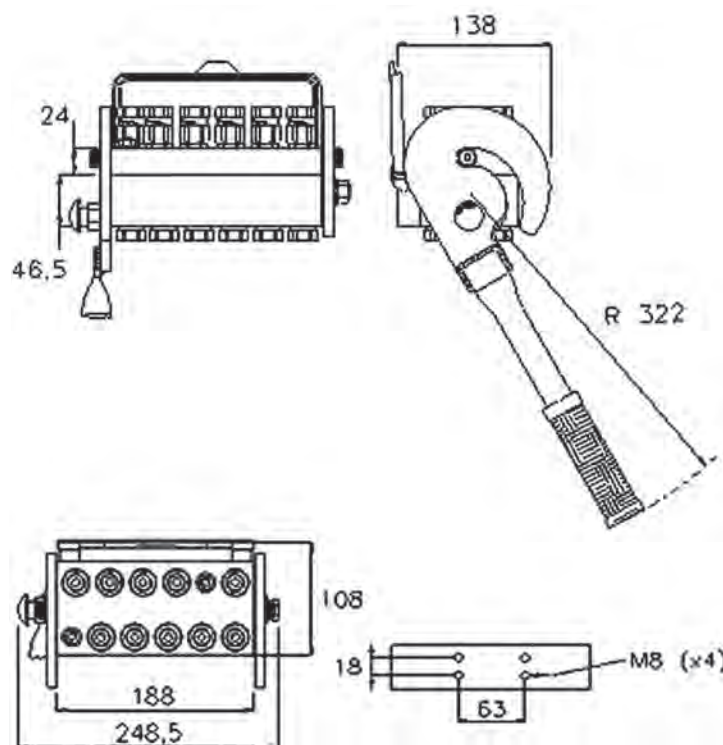

Technical Specifications

dash	Size		Working Pressure (MPa)	Flow Rate (l/min)	Spillage (ml)	Burst pressure (MPa)		
	mm	inch				Male	Female	Male + Female
04	6.3	1/4"	25	20	0.008	100	100	100

Material	Aluminium; Steel
Seals	NBR; PUR
Working temperatures	- 25 °C to + 100 °C
Surface treatment	MATE 500 (CrIII); Paint

Valve Type	Flat
Connection	Lever
Disconnection	Lever
Connection Under Pressure	Allowed Residual



P1004

Size					Thread Type					FIXED
dash	mm	inch	Housing	Number of Couplings	Thread Type	Standard	Thread	Electrical Connector N	Connector Type	Part Number
04	6.3	1/4"	10	10	F BSPP	ISO 1179-1	BSPP 1/4" FEMALE			2P1004-10-14GFC

Size					Thread Type					MOBILE
dash	mm	inch	Housing	Number of Couplings	Thread Type	Standard	Thread	Electrical Connector N	Connector Type	Part Number
04	6.3	1/4"	10	10	F BSPP	ISO 1179-1	BSPP 1/4" FEMALE			2P1004-10-14GMC

Spare Parts & Accessories

Female Half				Male Half					
Plates	Lever	Dust cover	Safety Lock	Plates	Seals male	Screws	Plugs	Guiding pins	Docking
		KIT TA P8	KIT SP5 S		SK MF 14	KIT VP8			

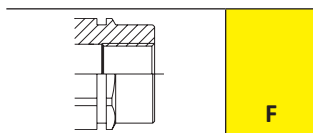



MF P10A

MultiFaster 10 lines.

5 lines size 04, 5 lines size 08.

Applications

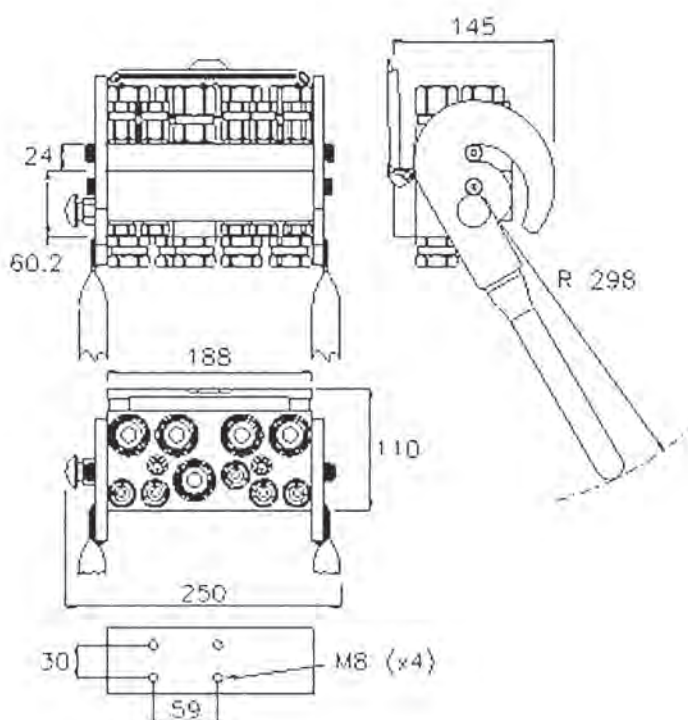

Technical Specifications

dash	Size		Working Pressure (MPa)	Flow Rate (l/min)	Spillage (ml)	Burst pressure (MPa)		
	mm	inch				Male	Female	Male + Female
04	6.3	1/4"	25	20	0.008	100	100	100
08	12.5	1/2"	25	70	0.01	100	100	100

Material	Aluminium; Steel
Seals	NBR; PUR
Working temperatures	- 25 °C to + 100 °C
Surface treatment	MATE 500 (CrIII); Paint

Valve Type	Flat
Connection	Lever
Disconnection	Lever
Connection Under Pressure	Allowed Residual



P10A

Size					Thread Type					FIXED
dash	mm	inch	Housing	Number of Couplings	Thread Type	Standard	Thread	Electrical Connector N	Connector Type	Part Number
04	6.3	1/4"	10	4	F BSPP	ISO 1179-1	BSPP 3/8" FEMALE			2P10A-A1-7-A FC
08	12.5	1/2"		3	F BSPP	ISO 1179-1	BSPP 3/4" FEMALE			
08	12.5	1/2"						1	3 PINS	
08	12.5	1/2"						1	7 PINS	
04	6.3	1/4"	10	5	F BSPP	ISO 1179-1	BSPP 1/4" FEMALE			2P10A-10-B F C
08	12.5	1/2"		5	F BSPP	ISO 1179-1	BSPP 1/2" FEMALE			
04	6.3	1/4"	10	5	O/ SAE	ISO 11926-1	9/16"-18 UNF FEMALE ORB			2P10A-10-A F C
08	12.5	1/2"		5	O/ SAE	ISO 11926-1	1-1/16"-12 UN FEMALE ORB			
04	6.3	1/4"	10	5	O/ SAE	ISO 11926-1	9/16"-18 UNF FEMALE ORB			3P10A-10-D FGC
08	12.5	1/2"		5	O/ SAE	ISO 11926-1	1-1/16"-12 UN FEMALE ORB			

Size					Thread Type					MOBILE
dash	mm	inch	Housing	Number of Couplings	Thread Type	Standard	Thread	Electrical Connector N	Connector Type	Part Number
04	6.3	1/4"	10	5	F BSPP	ISO 1179-1	BSPP 1/4 FEMALE			3P10A-10-B M C
08	12.5	1/2"		5	F BSPP	ISO 1179-1	BSPP 1/2 FEMALE			
04	6.3	1/4"	10	4	F BSPP	ISO 1179-1	BSPP 3/8" FEMALE			2P10A-A1-7-A MC
08	12.5	1/2"		3	F BSPP	ISO 1179-1	BSPP 3/4" FEMALE			
08	12.5	1/2"						1	3 PINS	
08	12.5	1/2"						1	7 PINS	
04	6.3	1/4"	10	5	O/ SAE	ISO 11926-1	9/16"-18 UNF FEMALE ORB			2P10A-10-A M C
08	12.5	1/2"		5	O/ SAE	ISO 11926-1	1-1/16"-12 UN FEMALE ORB			
04	6.3	1/4"	10	5	F BSPP	ISO 1179-1	BSPP 1/4" FEMALE			3P10A-10-C MGC
08	12.5	1/2"		5	F BSPP	ISO 1179-1	BSPP 1/2" FEMALE			

Spare Parts & Accessories

Female Half				Male Half					
Plates	Lever	Dust cover	Safety Lock	Plates	Seals male	Screws	Plugs	Guiding pins	Docking
	KIT LP10A	KIT TA P9	KIT SP5 S		SK MF 14	KIT VP8	KIT TSP 38 M	KIT GP4	
					SK MF 12				





MF P12A

MultiFaster 12 lines.

10 lines size 08, 2 lines size 04.

Applications

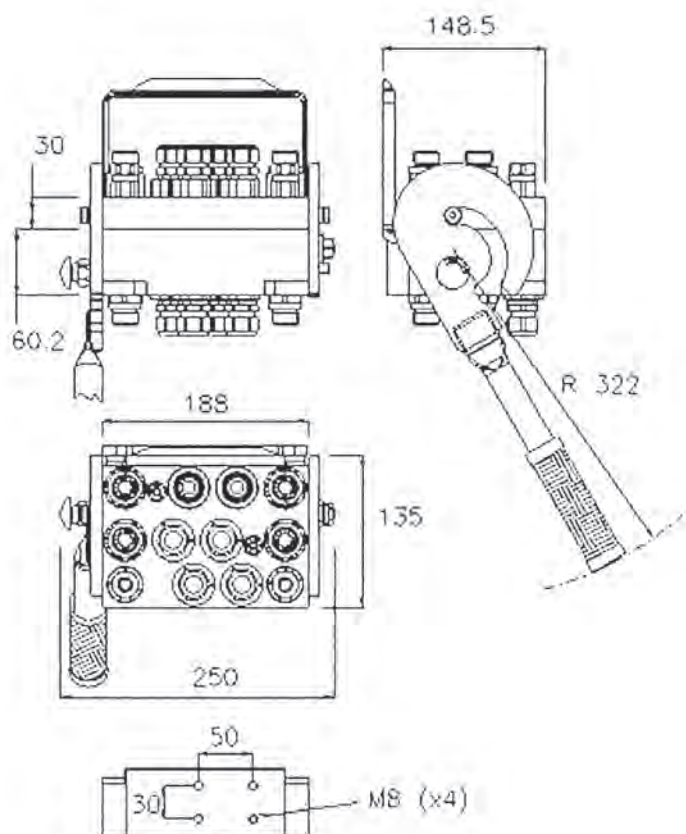

Technical Specifications

dash	Size		Working Pressure (MPa)	Flow Rate (l/min)	Spillage (ml)	Burst pressure (MPa)		
	mm	inch				Male	Female	Male + Female
04	6.3	1/4"	25	20	0.008	100	100	100
08	12.5	1/2"	25	70	0.01	100	100	100

Material	Aluminium; Stainless Steel; Steel
Seals	NBR; PUR
Working temperatures	- 25 °C to + 100 °C
Surface treatment	MATE 500 (CrIII); Paint

Valve Type	Flat
Connection	Lever
Disconnection	Lever
Connection Under Pressure	Allowed Residual



P12A

Size					Thread Type					FIXED
dash	mm	inch	Housing	Number of Couplings	Thread Type	Standard	Thread	Electrical N	Connector Type	Part Number
08	12.5	1/2"	12	10	F BSPP	ISO 1179-1	BSPP 1/2" FEMALE			2P12A-10-C F C*
08	12.5	1/2"	12	10	F BSPP	ISO 1179-1	BSPP 1/2" FEMALE			2P12A-10-A F C
04	6.3	1/4"	12	2	O/ SAE	ISO 11926-1	7/16"-20 UNF FEMALE ORB			2P12A-0-12-B FC
08	12.5	1/2"		10	O/ SAE	ISO 11926-1	3/4"-16 UNF FEMALE ORB			

*MultiFaster in Stainless Steel (AISI 316).

Size					Thread Type					MOBILE
dash	mm	inch	Housing	Number of Couplings	Thread Type	Standard	Thread	Electrical N	Connector Type	Part Number
08	12.5	1/2"	12	10	F BSPP	ISO 1179-1	BSPP 1/2" FEMALE			2P12A-10-C M C*
04	6.3	1/4"	12	2	O/ SAE	ISO 11926-1	7/16"-20 UNF FEMALE ORB			3P12A-0-12-B MC
08	12.5	1/2"		10	O/ SAE	ISO 11926-1	3/4"-16 UNF FEMALE ORB			
08	12.5	1/2"	12	10	F BSPP	ISO 1179-1	BSPP 1/2" FEMALE			2P12A-10-A M C

* MultiFaster in Stainless Steel (AISI 316).

Spare Parts & Accessories

Female Half				Male Half					
Plates	Lever	Dust cover	Safety Lock	Plates	Seals male	Screws	Plugs	Guiding pins	Docking
		KIT TA P8	KIT SP5 S		SK MF 14	KIT VP8	KIT TSP 38 M	KIT GP4	
					SK MF 12				





MF P12B

MultiFaster 12 lines, size 08.

Applications

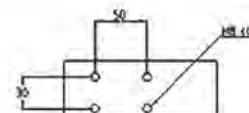
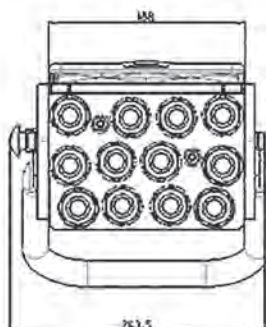
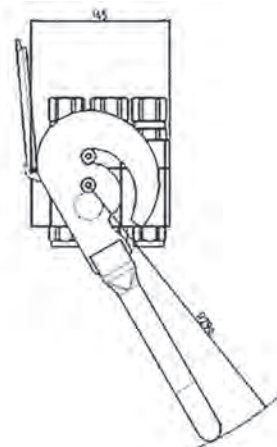
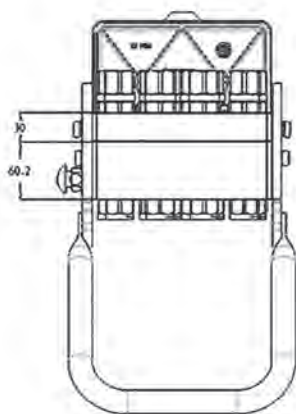

Technical Specifications

dash	Size		Working Pressure (MPa)	Flow Rate (l/min)	Spillage (ml)	Burst pressure (MPa)		
	mm	inch				Male	Female	Male + Female
08	12.5	1/2"	25	70	0.01	100	64	100

Material **Stainless Steel**

Seals **FKM**

Working temperatures **- 20 °C to + 200 °C**

Surface treatment

Valve Type **Flat**

Connection **Lever**

Disconnection **Lever**

Connection Under Pressure **Allowed Residual**



P12B

Size					Thread Type					FIXED
dash	mm	inch	Housing	Number of Couplings	Thread Type	Standard	Thread	Electrical Connector N	Connector Type	Part Number
08	12.5	1/2"	12	12	F BSP	ISO 1179-1	BSP 1/2" FEMALE			2P12B-12-AF2V C

Size					Thread Type					MOBILE
dash	mm	inch	Housing	Number of Couplings	Thread Type	Standard	Thread	Electrical Connector N	Connector Type	Part Number
08	12.5	1/2"	12	12	F BSP	ISO 1179-1	BSP 1/2" FEMALE			2P12B-12-AM2V C

Spare Parts & Accessories

Female Half				Male Half					
Plates	Lever	Dust cover	Safety Lock	Plates	Seals male	Screws	Plugs	Guiding pins	Docking
					SK MF 12		KIT TSP 38 M		

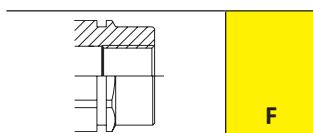



MF P1504

MultiFaster 15 lines, size 04.

Applications

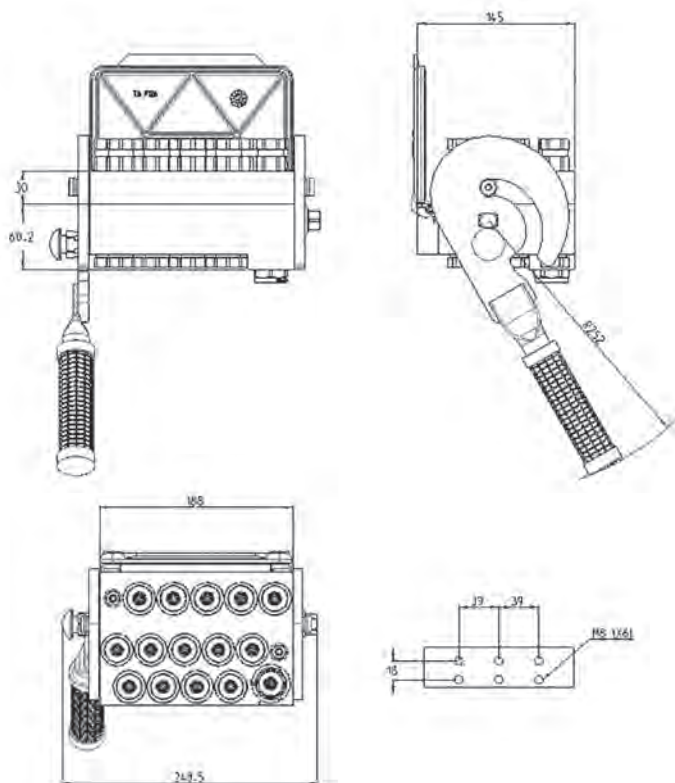

Technical Specifications

dash	Size		Working Pressure (MPa)	Flow Rate (l/min)	Spillage (ml)	Burst pressure (MPa)		
	mm	inch				Male	Female	Male + Female
04	6.3	1/4"	25	20	0.008	100	100	100

Material **Aluminium; Steel**

Seals **NBR; PUR**

Working temperatures **- 25 °C to 100 °C**

Surface treatment **MATE 500 (CrIII); Paint**

Valve Type **Flat**

Connection **Lever**

Disconnection **Lever**

Connection Under Pressure **Allowed Residual**



P1504

Size					Thread Type					FIXED
dash	mm	inch	Housing	Number of Couplings	Thread Type	Standard	Thread	Electrical Connector N	Connector Type	Part Number
04	6.3	1/4"	15	15	F BSPP	ISO 1179-1	BSPP 1/4" FEMALE			2P1504-15-14GFC

Size					Thread Type					MOBILE
dash	mm	inch	Housing	Number of Couplings	Thread Type	Standard	Thread	Electrical Connector N	Connector Type	Part Number
04	6.3	1/4"	15	15	F BSPP	ISO 1179-1	BSPP 1/4" FEMALE			2P1504-15-14GMC

Spare Parts & Accessories

Female Half				Male Half					
Plates	Lever	Dust cover	Safety Lock	Plates	Seals male	Screws	Plugs	Guiding pins	Docking
			KIT SP5 S		SK MF 14	KIT VP8		KIT GP4	

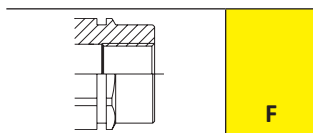

MultiFaster Harvesting

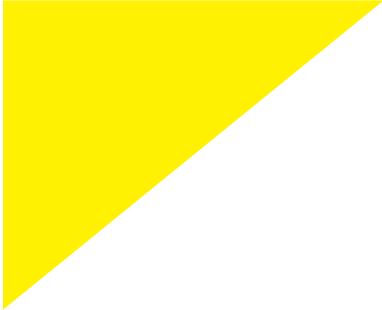

MultiFaster for Harvesting application.

PLV	page 345
PLK	page 347
P5065	page 349

For more detailed information about MultiFaster, please refer to the website fastercouplings.com



MF PLV

MultiFaster for harvesting application, 3 lines size 06, 2 lines size 09.

PLV series MultiFaster has been developed for harvesting applications. Interchangeable according to market driven standards. Three lines size 06, two lines size 09.

Applications

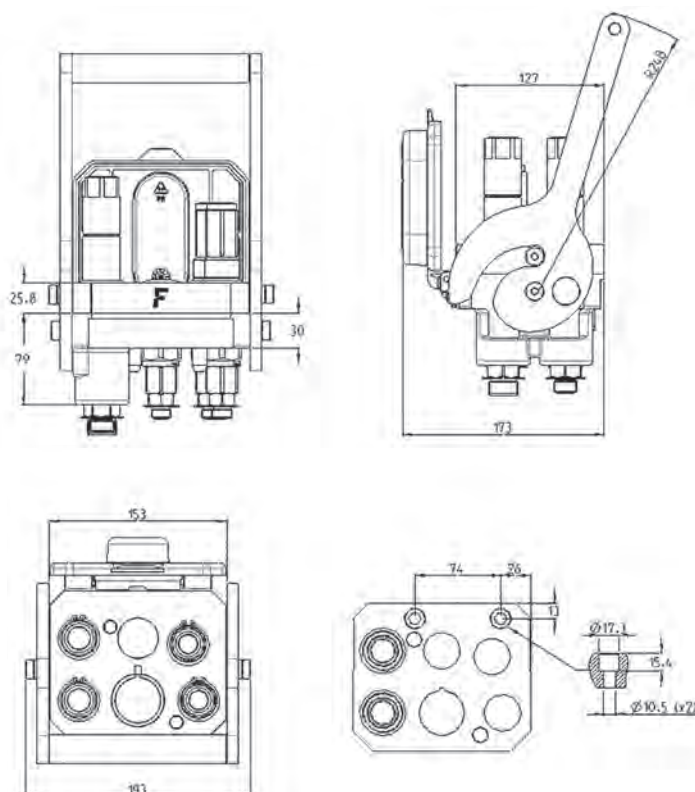

Technical Specifications

dash	Size		Working Pressure (MPa)	Flow Rate (l/min)	Spillage (ml)	Burst pressure (MPa)		
	mm	inch				Male	Female	Male + Female
06	10	3/8"	22	20	0.02	69	69	88
09	14.3	9/16"	22	35	0.02	69	69	88

Material	Cast Iron; Steel
Seals	NBR; PUR
Working temperatures	- 25 °C to 100 °C
Surface treatment	MATE 500 (CrIII)

Valve Type	Flat
Connection	Lever
Disconnection	Lever
Connection Under Pressure	Allowed Male Half up to W.P.



PLV

Size			Housing	Number of Couplings	Thread Type			Electrical Connector		FIXED
dash	mm	inch			Thread Type	Standard	Thread	N	Type	Part Number
06	10	3/8"	6	3	11/ SAE	ISO 8434-3	11/16"-16 UN MALE ORFS		3PLV-0-5-A F C	
09	14.3	9/16"		1	11/ SAE	ISO 8434-3	13/16"-16 UN MALE ORFS			
09	14.3	9/16"		1	11/ SAE	ISO 8434-3	1"-14 UNS MALE ORFS			

Size			Housing	Number of Couplings	Thread Type			Electrical Connector		MOBILE
dash	mm	inch			Thread Type	Standard	Thread	N	Type	Part Number
06	10	3/8"	6	1	11/ SAE	ISO 8434-3	11/16"-16 UN MALE ORFS		3PLV-0-3-B M C	
09	14.3	9/16"		1	11/ SAE	ISO 8434-3	1"-14 UNS MALE ORFS			
09	14.3	9/16"		1	11/ SAE	ISO 8434-3	13/16"-16 UN MALE ORFS			
06	10	3/8"	6	3	11/ SAE	ISO 8434-3	11/16"-16 UN MALE ORFS		3PLV-0-5-B M C	
09	14.3	9/16"		1	11/ SAE	ISO 8434-3	1"-14 UNS MALE ORFS			
09	14.3	9/16"		1	11/ SAE	ISO 8434-3	13/16"-16 UN MALE ORFS			
06	10	3/8"	6	3	11/ SAE	ISO 8434-3	11/16"-16 UN MALE ORFS		3PLV-0-5-C M C	
09	14.3	9/16"		2	0/ SAE	ISO 11926-1	7/8"-14 UNF FEMALE ORB			
06	10	3/8"	6	3	11/ SAE	ISO 8434-3	11/16"-16 UN MALE ORFS		3PLV-0-5-A M C	
09	14.3	9/16"		1	11/ SAE	ISO 8434-3	13/16"-16 UN MALE ORFS			
09	14.3	9/16"		1	11/ SAE	ISO 8434-3	1"-14 UNS MALE ORFS			
06	10	3/8"	6	2	0/ SAE	ISO 11926-1	3/4" - 16 UNF FEMALE ORB		3PLV-0-4-A M C	
09	14.3	9/16"		2	0/ SAE	ISO 11926-1	7/8"-14 UNF FEMALE ORB			
06	10	3/8"	6	2	11/ SAE	ISO 8434-3	11/16"-16 UN MALE ORFS		3PLV-0-2-A M C	

Spare Parts & Accessories

Female Half				Male Half					
Plates	Lever	Dust cover	Safety Lock	Plates	Seals male	Screws	Plugs	Guiding pins	Docking
KIT PLV F L	KIT LPLV			KIT PLV M	SK MF 38	KIT VPLK M	KIT TSP 12 M		
					SK MF 916		KIT TPLK 32		

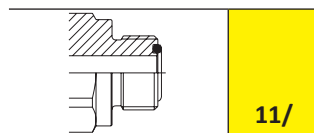
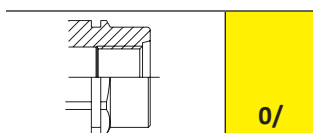



MF PLK

MultiFaster for harvesting application, 2 lines size 06, 3 lines size 09.

PLK series MultiFaster has been developed for harvesting applications. Interchangeable according to market driven standards. Two lines size 06, three lines size 09.

Applications

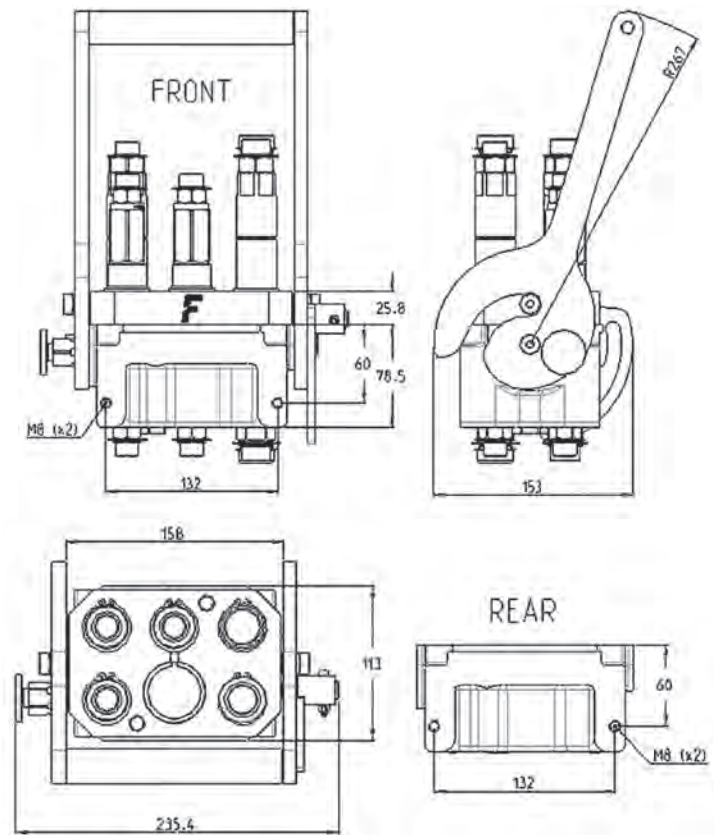

Technical Specifications

dash	Size mm	inch	Working Pressure (MPa)	Flow Rate (l/min)	Spillage (ml)	Burst pressure (MPa)		
						Male	Female	Male + Female
06	10	3/8"	25	20	0.02	100	69	88
09	14.3	9/16"	25	35	0.02	100	69	88

Material	Cast Iron; Steel
Seals	NBR; PUR
Working temperatures	- 25 °C to + 100 °C
Surface treatment	MATE 500 (CrIII)

Valve Type	Flat
Connection	Lever
Disconnection	Lever
Connection Under Pressure	Allowed Male Half up to W.P.



PLK

Size					Thread Type					FIXED
dash	mm	inch	Housing	Number of Couplings	Thread Type	Standard	Thread	Electrical Connector N	Connector Type	Part Number
06	10	3/8"	6	2	11/ SAE	ISO 8434-3	11/16"-16 UN MALE ORFS			3PLK-0-5-B F C
09	14.3	9/16"		1	11/ SAE	ISO 8434-3	11/16"-16 UN MALE ORFS			
09	14.3	9/16"		1	11/ SAE	ISO 8434-3	13/16"-16 UN MALE ORFS			
09	14.3	9/16"		1	11/ SAE	ISO 8434-3	1"-14 UNS MALE ORFS			
06	10	3/8"	6	2	11/ SAE	ISO 8434-3	11/16"-16 UN MALE ORFS			3PLK-0-5-A F C
09	14.3	9/16"		1	11/ SAE	ISO 8434-3	11/16"-16 UN MALE ORFS			
09	14.3	9/16"		1	11/ SAE	ISO 8434-3	13/16"-16 UN MALE ORFS			
09	14.3	9/16"		1	11/ SAE	ISO 8434-3	1"-14 UNS MALE ORFS			

Size					Thread Type					MOBILE
dash	mm	inch	Housing	Number of Couplings	Thread Type	Standard	Thread	Electrical Connector N	Connector Type	Part Number
06	10	3/8"	6	2	11/ SAE	ISO 8434-3	11/16"-16 UN MALE ORFS			3PLK-0-5-C M C
09	14.3	9/16"		3	11/ SAE	ISO 8434-3	11/16"-16 UN MALE ORFS			
06	10	3/8"	6	2	11/ SAE	ISO 8434-3	11/16"-16 UN MALE ORFS			3PLK-0-4-A M C
09	14.3	9/16"		1	11/ SAE	ISO 8434-3	11/16"-16 UN MALE ORFS			
09	14.3	9/16"		1	11/ SAE	ISO 8434-3	13/16"-16 UN MALE ORFS			
06	10	3/8"	6	2	11/ SAE	ISO 8434-3	11/16"-16 UN MALE ORFS			3PLK-0-5-B M C
09	14.3	9/16"		1	11/ SAE	ISO 8434-3	11/16"-16 UN MALE ORFS			
09	14.3	9/16"		1	11/ SAE	ISO 8434-3	13/16"-16 UN MALE ORFS			
09	14.3	9/16"		1	11/ SAE	ISO 8434-3	1"-14 UNS MALE ORFS			
06	10	3/8"	6	2	11/ SAE	ISO 8434-3	11/16"-16 UN MALE ORFS			3PLK-0-5-A M C
09	14.3	9/16"		1	11/SAE	ISO 8434-3	11/16"-16 UN MALE ORFS			
09	14.3	9/16"		1	11/ SAE	ISO 8434-3	13/16"-16 UN MALE ORFS			
09	14.3	9/16"		1	11/ SAE	ISO 8434-3	1"-14 UNS MALE ORFS			
06	10	3/8"	6	2	0/ SAE	ISO 11926-1	3/4"-16 UNF MALE ORFS			3PLK-0-2-C M C
09	14.3	9/16"	6	1	11/ SAE	ISO 8434-3	13/16"-16 UN MALE ORFS			3PLK-0-2-B M C
09	14.3	9/16"		1	11/ SAE	ISO 8434-3	1"-14 UNS MALE ORFS			
06	10	3/8"	6	2	11/ SAE	ISO 8434-3	11/16"-16 UN MALE ORFS			3PLK-0-2-A M C

Spare Parts & Accessories

Female Half				Male Half					
Plates	Lever	Dust cover	Safety Lock	Plates	Seals male	Screws	Plugs	Guiding pins	Docking
KIT PLK F L			KIT SP6	KIT PLK M	SK MF 38	KIT VPLK M	KIT TSP 12 M		
					SK MF 916		KIT TPLK 32		

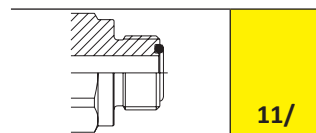
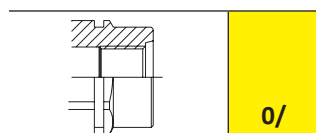



MF P5065

MultiFaster 5 lines, 2 lines 06, 3 lines 04.

Applications

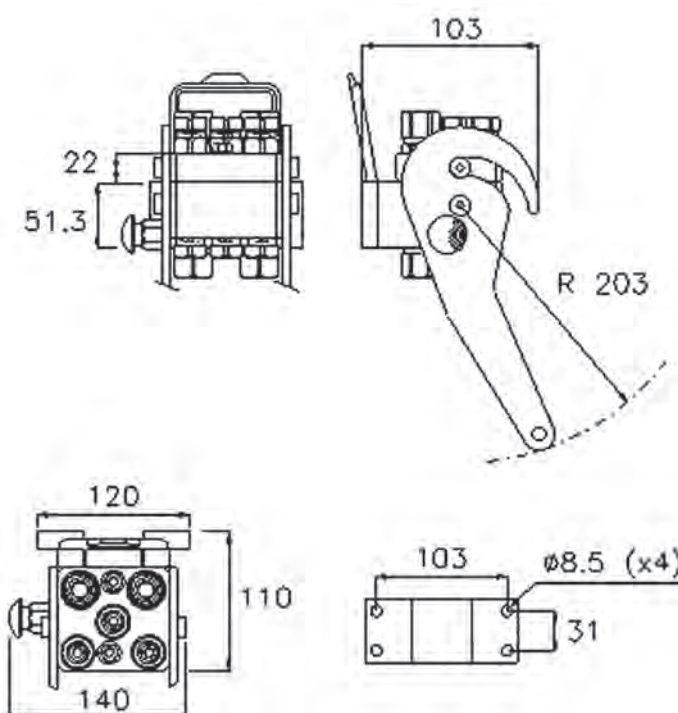

Technical Specifications

dash	Size		Working Pressure (MPa)	Flow Rate (l/min)	Spillage (ml)	Burst pressure (MPa)		
	mm	inch				Male	Female	Male + Female
04	6.3	1/4"	25	20	0.008	100	100	100
06	10	3/8"	25	40	0.008	100	100	100

Material	Aluminium; Steel
Seals	NBR; PUR
Working temperatures	- 25 °C to + 100 °C
Surface treatment	MATE 500 (CrIII); Paint

Valve Type	Flat
Connection	Lever
Disconnection	Lever
Connection Under Pressure	Allowed Residual



P5065

Size					Thread Type			Electrical Connector		FIXED
dash	mm	inch	Housing	Number of Couplings	Thread Type	Standard	Thread	N	Type	Part Number
04	6.3	1/4"	5	3	F BSPP	ISO 1179-1	BSPP 1/4" FEMALE			2P5065-5-F F C
06	10	3/8"		2	F BSPP	ISO 1179-1	BSPP 1/2" FEMALE			
04	6.3	1/4"	5	2	O/ SAE	ISO 11926-1	3/4" - 16 UNF FEMALE ORB			2P5065-4-A F C
06	10	3/8"		2	O/ SAE	ISO 11926-1	9/16" - 18 UNF FEMALE ORB			
04	6.3	1/4"	5	1	O/ SAE	ISO 11926-1	9/16" - 18 UNF FEMALE ORB			2P5065-3-A1 F C
06	10	3/8"		2	O/ SAE	ISO 11926-1	3/4" - 16 UNF FEMALE ORB			
04	6.3	1/4"	5	2	O/ SAE	ISO 11926-1	9/16" - 18 UNF FEMALE ORB			2P5065-2-A F C
04	6.3	1/4"	5	2	F BSPP	ISO 1179-1	BSPP 1/4" FEMALE			2P5065-2-14G FC
06	10	3/8"	5	2	F BSPP	ISO 1179-1	BSPP 1/2" FEMALE			2P5065-2-12G FC
04	6.3	1/4"	5	3	O/ SAE	ISO 11926-1	9/16" - 18 UNF FEMALE ORB			2P5065-5-A F C
06	10	3/8"		2	O/ SAE	ISO 11926-1	3/4" - 16 UNF FEMALE ORB			
04	6.3	1/4"	5	3	O/ SAE	ISO 11926-1	9/16" - 18 UNF FEMALE ORB			2P5065-3-A F C

Size					Thread Type			Electrical Connector		MOBILE
dash	mm	inch	Housing	Number of Couplings	Thread Type	Standard	Thread	N	Type	Part Number
04	6.3	1/4"	5	3	F BSPP	ISO 1179-1	BSPP 1/4" FEMALE			3P5065-5-F M C
06	10	3/8"		2	F BSPP	ISO 1179-1	BSPP 3/8" FEMALE			
04	6.3	1/4"	5	3	O/ SAE	ISO 11926-1	9/16"-18 UNF FEMALE ORB			3P5065-5-A M C
06	10	3/8"		2	O/ SAE	ISO 11926-1	3/4" - 16 UNF FEMALE ORB			
04	6.3	1/4"	5	2	O/ SAE	ISO 11926-1	9/16" - 18 UNF FEMALE ORB			3P5065-4-A M C
06	10	3/8"		2	O/ SAE	ISO 11926-1	3/4" - 16 UNF FEMALE ORB			
04	6.3	1/4"	5	3	O/ SAE	ISO 11926-1	9/16"-18 UNF FEMALE ORB			3P5065-3-A M C
04	6.3	1/4"	5	2	O/ SAE	ISO 11926-1	9/16"-18 UNF FEMALE ORB			3P5065-2-38S MC

Spare Parts & Accessories

Female Half				Male Half					
Plates	Lever	Dust cover	Safety Lock	Plates	Seals male	Screws	Plugs	Guiding pins	Docking
KIT P5065 F L		KIT TA P5	KIT SP5 S	KIT P5065 M	SK MF 14	KIT VP4	KIT TSP 12 M	KIT GP4	S P5065
					SK MF 38				

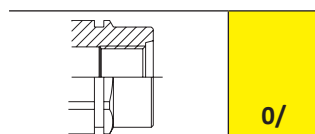
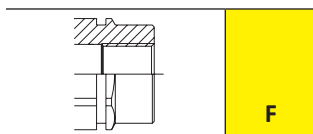

MultiFaster G Type

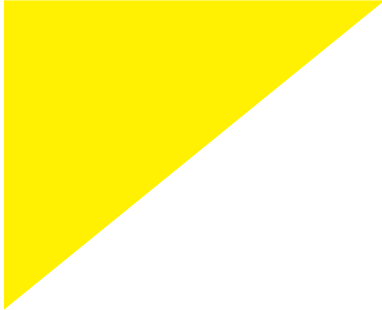

MultiFaster with grease nipple and Zinc-Nickel plating.

P206G	page 353
P208G	page 355
P506G	page 357
P508G	page 359
P510G	page 361
P608G	page 363
P808G	page 365

For more detailed information about MultiFaster, please refer to the website fastercouplings.com



MF P206G

MultiFaster 2 lines, size 06, "G" type, with greaser and Zinc-Nickel plating.

Applications

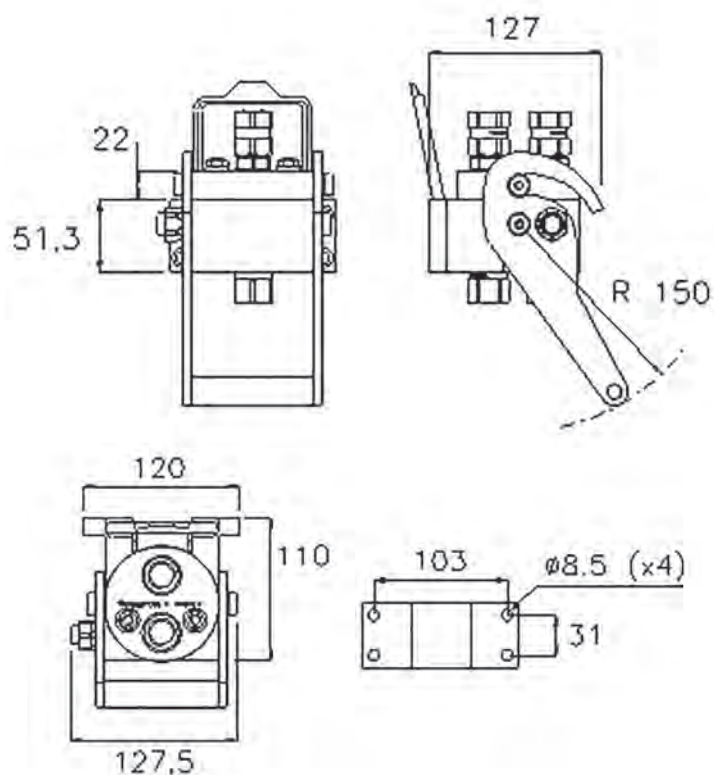

Technical Specifications

dash	Size		Working Pressure (MPa)	Flow Rate (l/min)	Spillage (ml)	Burst pressure (MPa)		
	mm	inch				Male	Female	Male + Female
06	10	3/8"	25	40	0.008	100	100	100

Material	Aluminium; Steel
Seals	NBR; PUR
Working temperatures	- 25 °C to + 100 °C
Surface treatment	MATE 1000 (ZnNi); Paint

Valve Type	Flat
Connection	Lever
Disconnection	Lever
Connection Under Pressure	Allowed Residual



P206G

Size					Thread Type					FIXED
dash	mm	inch	Housing	Number of Couplings	Thread Type	Standard	Thread	Electrical Connector N	Connector Type	Part Number
06	10	3/8"	2	2	F BSPP	ISO 1179-1	BSPP 1/2" FEMALE			2P206G-2-12G FC

Size					Thread Type					MOBILE
dash	mm	inch	Housing	Number of Couplings	Thread Type	Standard	Thread	Electrical Connector N	Connector Type	Part Number
06	10	3/8"	2	2	F BSPP	ISO 1179-1	BSPP 3/8" FEMALE			3P206G-2-12G MC

Spare Parts & Accessories

Female Half				Male Half					
Plates	Lever	Dust cover	Safety Lock	Plates	Seals male	Screws	Plugs	Guiding pins	Docking
	KIT LP206G	KIT TA P2	KIT SP4 7		SK MF 38	KIT VP4 7	KIT TSP 12 M	KIT GP4 7	

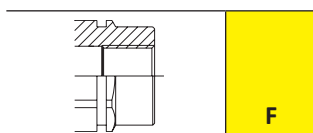



MF P208G

MultiFaster 2 lines, size 08, "G" type, with greaser and Zinc-Nickel plating.

Applications

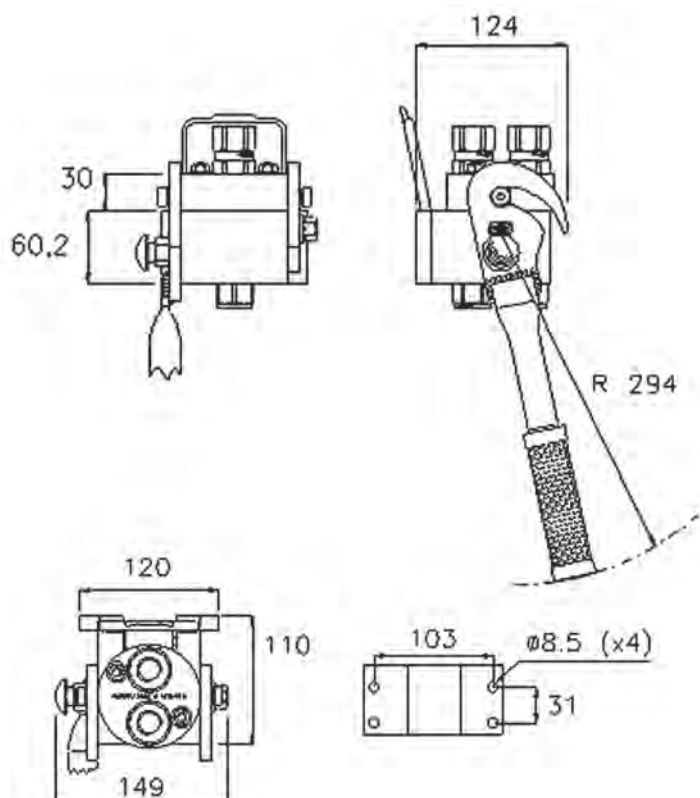

Technical Specifications

dash	Size		Working Pressure (MPa)	Flow Rate (l/min)	Spillage (ml)	Burst pressure (MPa)		
	mm	inch				Male	Female	Male + Female
08	12.5	1/2"	25	70	0.01	100	100	100

Material	Aluminium; Steel
Seals	NBR; PUR
Working temperatures	- 25 °C to + 100 °C
Surface treatment	MATE 1000 (ZnNi); Paint

Valve Type	Flat
Connection	Lever
Disconnection	Lever
Connection Under Pressure	Allowed Residual



P208G

Size					Thread Type					FIXED
dash	mm	inch	Housing	Number of Couplings	Thread Type	Standard	Thread	Electrical Connector N	Connector Type	Part Number
08	12.5	1/2"	2	2	F BSP	ISO 1179-1	BSP 1/2" FEMALE			2P208G-2-12G FC

Size					Thread Type					MOBILE
dash	mm	inch	Housing	Number of Couplings	Thread Type	Standard	Thread	Electrical Connector N	Connector Type	Part Number
08	12.5	1/2"	2	2	F BSP	ISO 1179-1	BSP 1/2" FEMALE			3P208G-2-12G MC

Spare Parts & Accessories

Female Half				Male Half					
Plates	Lever	Dust cover	Safety Lock	Plates	Seals male	Screws	Plugs	Guiding pins	Docking
	KIT LP208G	KIT TA P2	KIT SP5 7		SK MF 12	KIT VP8 7	KIT TSP 38 M	KIT GP4 7	
			KIT SP5 S						

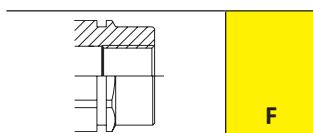



MF P506G

MultiFaster 4 lines, size 06, "G" type, with greaser and Zinc-Nickel plating.

Applications

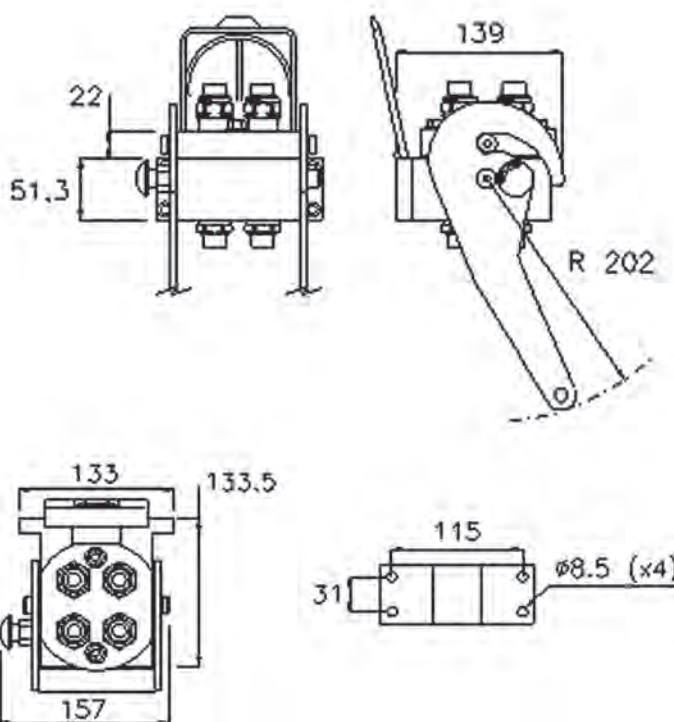

Technical Specifications

dash	Size		Working Pressure (MPa)	Flow Rate (l/min)	Spillage (ml)	Burst pressure (MPa)		
	mm	inch				Male	Female	Male + Female
06	10	3/8"	25	40	0.008	100	100	100

Material	Aluminium; Steel
Seals	NBR; PUR
Working temperatures	- 25 °C to + 100 °C
Surface treatment	MATE 1000 (ZnNi); Paint

Valve Type	Flat
Connection	Lever
Disconnection	Lever
Connection Under Pressure	Allowed Residual



P506G

Size					Thread Type					FIXED
dash	mm	inch	Housing	Number of Couplings	Thread Type	Standard	Thread	Electrical Connector N	Connector Type	Part Number
06	10	3/8"	4	4	F BSP	ISO 1179-1	BSP 1/2" FEMALE			2P506G-4-12G FC

Size					Thread Type					MOBILE
dash	mm	inch	Housing	Number of Couplings	Thread Type	Standard	Thread	Electrical Connector N	Connector Type	Part Number
06	10	3/8"	4	4	F BSP	ISO 1179-1	BSP 1/2" FEMALE			3P506G-4-12G MC

Spare Parts & Accessories

Female Half				Male Half					
Plates	Lever	Dust cover	Safety Lock	Plates	Seals male	Screws	Plugs	Guiding pins	Docking
KIT P506G F L	KIT LP506G	KIT TA P5	KIT SP5 7		SK MF 38	KIT VP4 7	KIT TSP 12 M	KIT GP4 7	

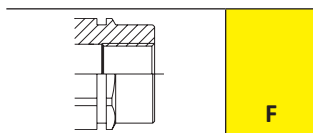



MF P508G

MultiFaster 4 lines, "G" type, with greaser and Zinc-Nickel plating.

Applications

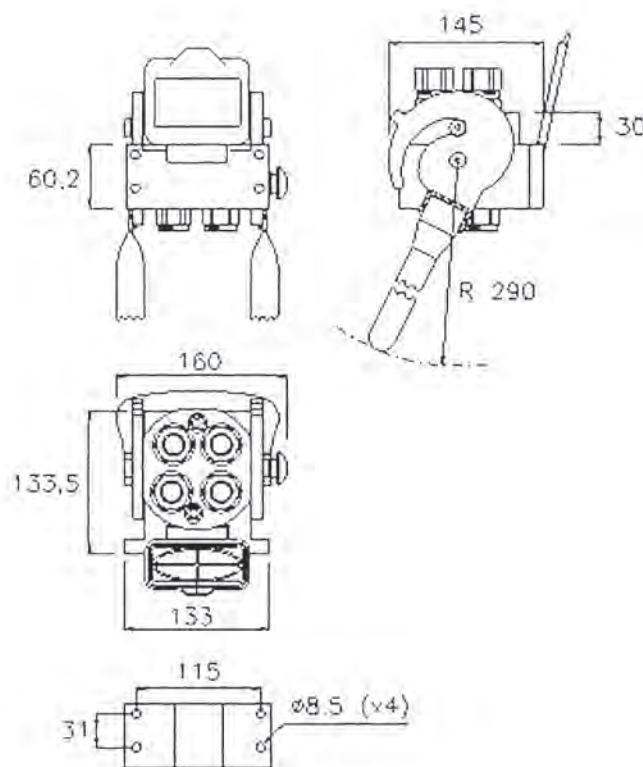

Technical Specifications

dash	Size mm	inch	Working Pressure (MPa)	Flow Rate (l/min)	Spillage (ml)	Burst pressure (MPa)		
						Male	Female	Male + Female
08	12.5	1/2"	25	70	0.01	100	100	100

Material	Aluminium; Steel
Seals	NBR; PUR
Working temperatures	- 25 °C to + 100 °C
Surface treatment	MATE 1000 (ZnNi); Paint

Valve Type	Flat
Connection	Lever
Disconnection	Lever
Connection Under Pressure	Allowed Residual



P508G

Size					Thread Type					FIXED
dash	mm	inch	Housing	Number of Couplings	Thread Type	Standard	Thread	Electrical Connector N	Connector Type	Part Number
08	12.5	1/2"	4	4	F BSPP	ISO 1179-1	BSPP 1/2" FEMALE			2P508G-4-12G FC

Size					Thread Type					MOBILE
dash	mm	inch	Housing	Number of Couplings	Thread Type	Standard	Thread	Electrical Connector N	Connector Type	Part Number
08	12.5	1/2"	4	4	F BSPP	ISO 1179-1	BSPP 1/2" FEMALE			3P508G-4-12G MC
08	12.5	1/2"	4	4	F BSPP	ISO 1179-1	BSPP 1/2" FEMALE			2P508G-4-12G MC

Spare Parts & Accessories

Female Half				Male Half					
Plates	Lever	Dust cover	Safety Lock	Plates	Seals male	Screws	Plugs	Guiding pins	Docking
	KIT LP508G	KIT TA P5	KIT SP5 7		SK MF 12	KIT VP8 7	KIT TSP 38 M	KIT GP4 7	

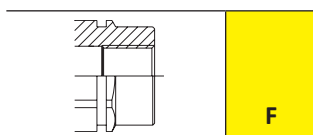



MF P510G

MultiFaster 4 lines, "G" type, with greaser and Zinc-Nickel plating. 2 lines size 08, 2 lines size 12.

Applications

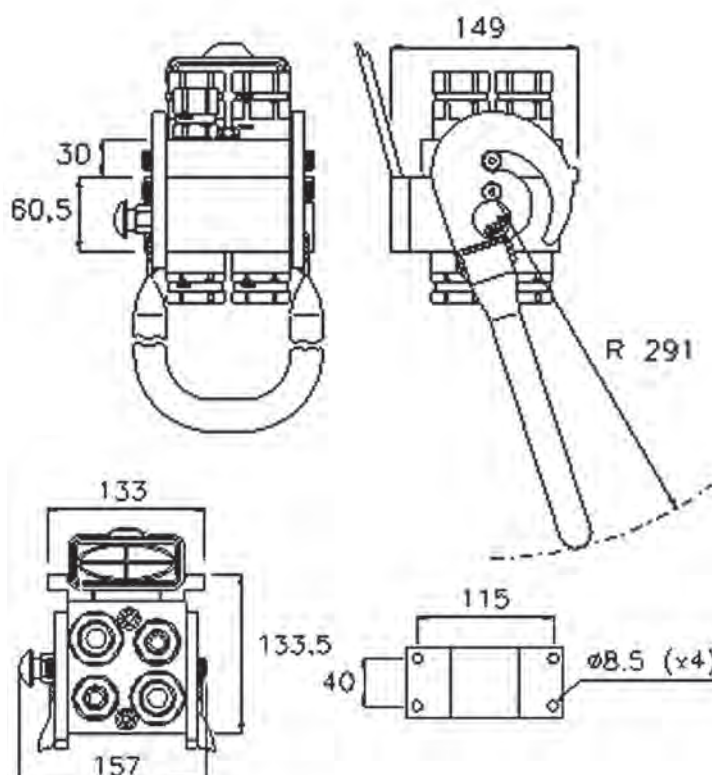

Technical Specifications

dash	Size mm	inch	Working Pressure (MPa)	Flow Rate (l/min)	Spillage (ml)	Burst pressure (MPa)		
						Male	Female	Male + Female
08	12.5	1/2"	25	70	0.01	100	100	100
12	20	3/4"	25	105	0.02	100	100	100

Material	Aluminium; Steel
Seals	NBR; PUR
Working temperatures	- 25 °C to + 100 °C
Surface treatment	MATE 1000 (ZnNi); Paint

Valve Type	Flat
Connection	Lever
Disconnection	Lever
Connection Under Pressure	Allowed Residual



P510G

Size					Thread Type					FIXED
dash	mm	inch	Housing	Number of Couplings	Thread Type	Standard	Thread	Electrical Connector N	Connector Type	Part Number
08	12.5	1/2"	4	2	F BSPP	ISO 1179-1	BSPP 1/2" FEMALE			2P510G-4-A F C
12	20	3/4"		2	F BSPP	ISO 1179-1	BSPP 3/4" FEMALE			

Size					Thread Type					MOBILE
dash	mm	inch	Housing	Number of Couplings	Thread Type	Standard	Thread	Electrical Connector N	Connector Type	Part Number
08	12.5	1/2"	4	2	F BSPP	ISO 1179-1	BSPP 1/2" FEMALE			3P510G-4-A M C
12	20	3/4"		2	F BSPP	ISO 1179-1	BSPP 3/4" FEMALE			

Spare Parts & Accessories

Female Half				Male Half					
Plates	Lever	Dust cover	Safety Lock	Plates	Seals male	Screws	Plugs	Guiding pins	Docking
	KIT LP510G	KIT TA P5	KIT SP5 7		SK MF 12	KIT VP8 7	KIT TSP 38 M	KIT GP4 7	
					SK MF 34		KIT TSP 34 M		

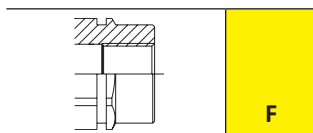



MF P608G

MultiFaster 6 lines, size 08, "G" type, with greaser and Zinc-Nickel plating.

Applications

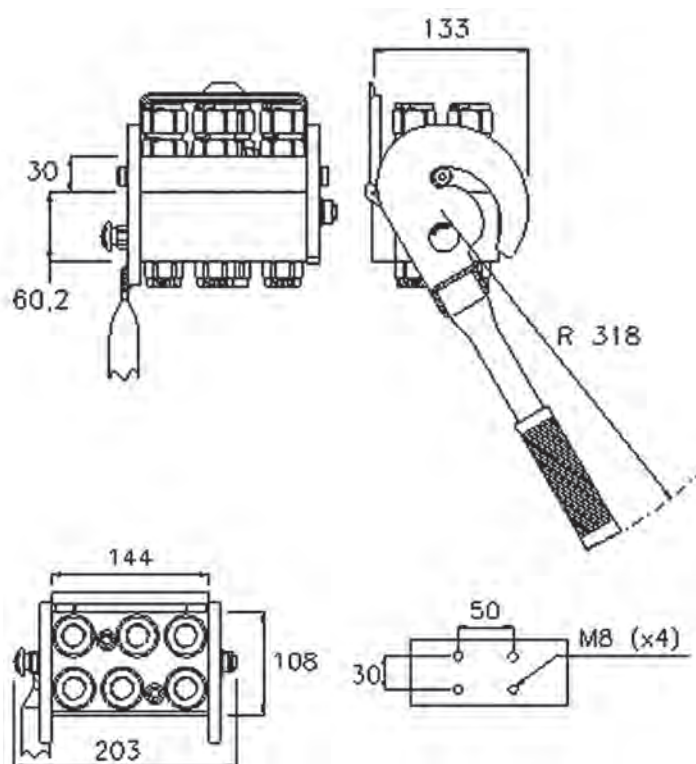

Technical Specifications

dash	Size		Working Pressure (MPa)	Flow Rate (l/min)	Spillage (ml)	Burst pressure (MPa)		
	mm	inch				Male	Female	Male + Female
08	12.5	1/2"	25	70	0.01	100	100	100

Material	Aluminium; Steel
Seals	NBR; PUR
Working temperatures	- 25 °C to + 100 °C
Surface treatment	MATE 1000 (ZnNi); Paint

Valve Type	Flat
Connection	Lever
Disconnection	Lever
Connection Under Pressure	Allowed Residual



P608G

Size					Thread Type					FIXED
dash	mm	inch	Housing	Number of Couplings	Thread Type	Standard	Thread	Electrical Connector N	Connector Type	Part Number
08	12.5	1/2"	6	6	F BSPP	ISO 1179-1	BSPP 1/2" FEMALE			2P608G-6-12G FC
08	12.5	1/2"	6	4	03/ METRIC	ISO 8434-1-S	M24x1.5 MALE 16S			2P608G-4-E F C

Size					Thread Type					MOBILE
dash	mm	inch	Housing	Number of Couplings	Thread Type	Standard	Thread	Electrical Connector N	Connector Type	Part Number
08	12.5	1/2"	6	6	F BSPP	ISO 1179-1	BSPP 1/2" FEMALE			3P608G-6-12G MC
08	12.5	1/2"	6	4	F BSPP	ISO 1179-1	BSPP 1/2" FEMALE			3P608G-4-E M C
08	12.5	1/2"	6	6	F BSPP	ISO 1179-1	BSPP 1/2" FEMALE			2P608G-6-12G MC

Spare Parts & Accessories

Female Half				Male Half					
Plates	Lever	Dust cover	Safety Lock	Plates	Seals male	Screws	Plugs	Guiding pins	Docking
	KIT LP608G	KIT TA P608	KIT SP5 7		SK MF 12	KIT VP8 7	KIT TSP 38 M	KIT GP4 7	





MF P808G

MultiFaster 8 lines, size 08, "G" type, with greaser and Zinc-Nickel plating.

Applications

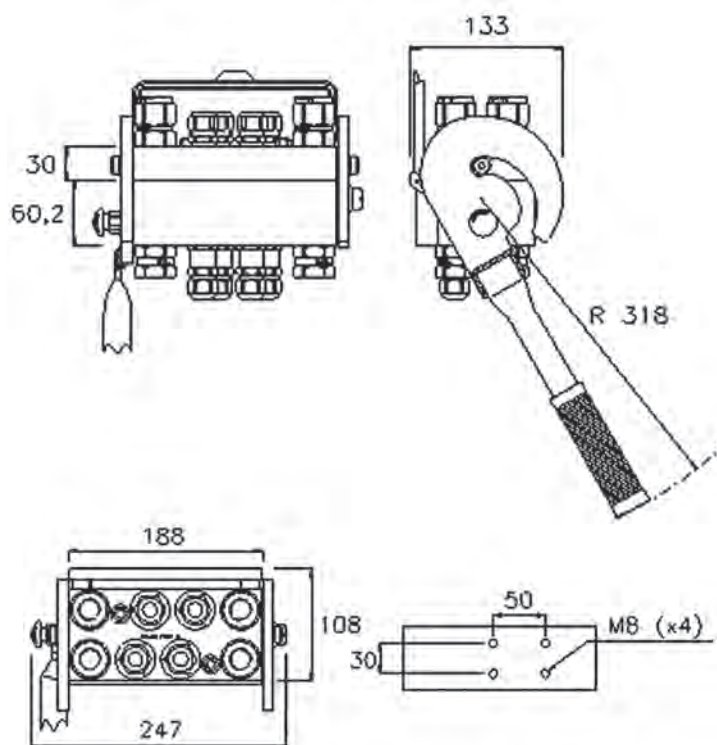

Technical Specifications

dash	Size		Working Pressure (MPa)	Flow Rate (l/min)	Spillage (ml)	Burst pressure (MPa)		
	mm	inch				Male	Female	Male + Female
08	12.5	1/2"	25	70	0.01	100	100	100

Material	Aluminium; Steel
Seals	NBR; PUR
Working temperatures	- 25 °C to + 100 °C
Surface treatment	MATE 1000 (ZnNi); Paint

Valve Type	Flat
Connection	Lever
Disconnection	Lever
Connection Under Pressure	Allowed Residual



P808G

Size					Thread Type					FIXED
dash	mm	inch	Housing	Number of Couplings	Thread Type	Standard	Thread	Electrical Connector N	Connector Type	Part Number
08	12.5	1/2"	8	8	F BSPP	ISO 1179-1	BSPP 1/2" FEMALE			2P808G-8-12G FC

Size					Thread Type					MOBILE
dash	mm	inch	Housing	Number of Couplings	Thread Type	Standard	Thread	Electrical Connector N	Connector Type	Part Number
08	12.5	1/2"	8	8	F BSPP	ISO 1179-1	BSPP 1/2" FEMALE			3P808G-8-12G MC

Spare Parts & Accessories

Female Half				Male Half					
Plates	Lever	Dust cover	Safety Lock	Plates	Seals male	Screws	Plugs	Guiding pins	Docking
	KIT LP808G	KIT TA P8			SK MF 12		KIT TSP 38 M	KIT GP8 7	

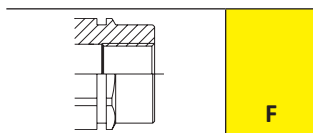

MultiFaster High Pressure

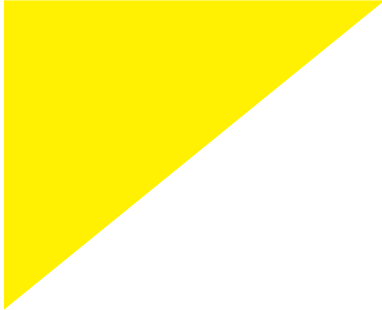

Multi-connection specifically designed to withstand high pressure applications (42 MPa).

PH216S	page 371
PH406S	page 373
PH408S	page 375
PH510S	page 377

MF Pressure Drop

PH216S

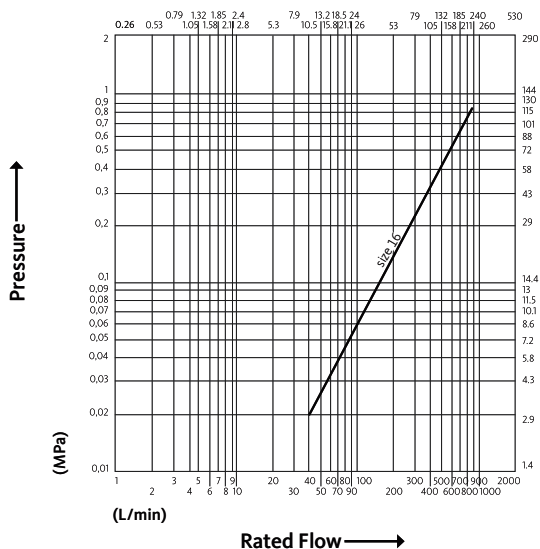

Test performed according to ISO 18869

PH406S

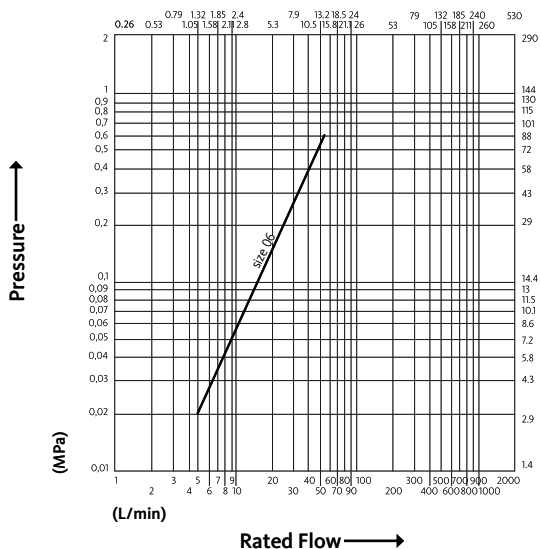

Test performed according to ISO 18869

PH408S

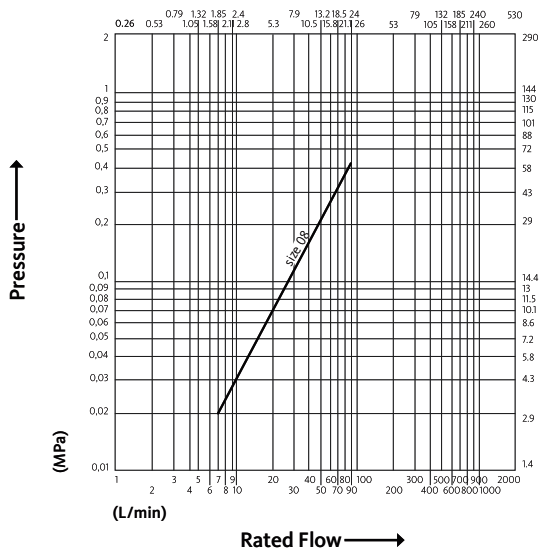

Test performed according to ISO 18869

PH510S

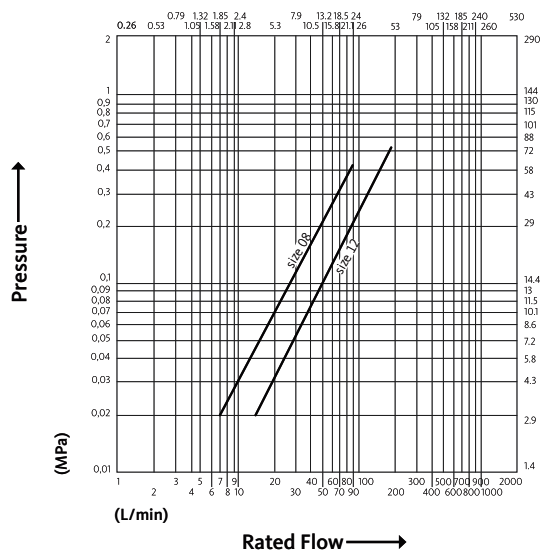

Test performed according to ISO 18869

MF PH216S



MultiFaster, high pressure version, 2 lines size 16.

New multi-connection system specifically designed to withstand high pressure applications (46 MPa). Equipped with 2 lines size 16. Black cataphoresis plates with Zn-Ni plated carbon steel handle and cams.



Applications

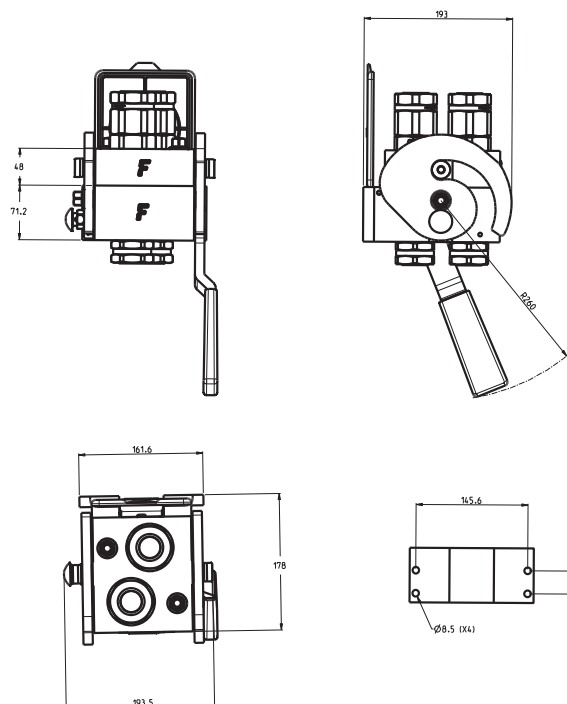

Technical Specifications

dash	Size		Working Pressure (MPa)	Flow Rate (l/min)	Spillage (ml)	Burst pressure (MPa)		
	mm	inch				Male	Female	Male + Female
16	25	1"	46	150	0.03	138	138	138

Material	Steel
Seals	FKM & PUR
Working temperatures	-25 °C to 100 °C
Surface treatment	MATE 1000 (ZnNi);

Valve Type	Flat
Connection	Screw to Connect
Disconnection	Unscrew to Disconnect
Connection Under Pressure	Allowed Male Half up to W.P.



PH216S

Size					Thread Type					FIXED
dash	mm	inch	Housing	Number of Couplings	Thread Type	Standard	Thread	Electrical Connector N	Connector Type	Part Number
16	25	1"	2	2	F BSPP	ISO 1179-1	BSPP 1" FEMALE			PH216S-2-1G F C

Size					Thread Type					MOBILE
dash	mm	inch	Housing	Number of Couplings	Thread Type	Standard	Thread	Electrical Connector N	Connector Type	Part Number
16	25	1"	2	2	F BSPP	ISO 1179-1	BSPP 1" FEMALE			3PH216S-2-1G M C

Spare Parts & Accessories

Female Half				Male Half					
Plates	Lever	Dust cover	Safety Lock	Plates	Seals male	Screws	Plugs	Guiding pins	Docking
			KIT SP5 7		SK MF 1	KIT VPH			

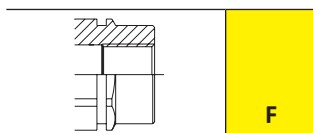



MF PH406S

MultiFaster, high pressure version, 4 lines size 06.

New multi-connection system specifically designed to withstand high pressure applications (42 MPa). Equipped with 4 lines size 06. Black cataphoresis plates with Zn-Ni plated carbon steel handle and cams or red paint plates with stainless steel handle and cams.



Applications

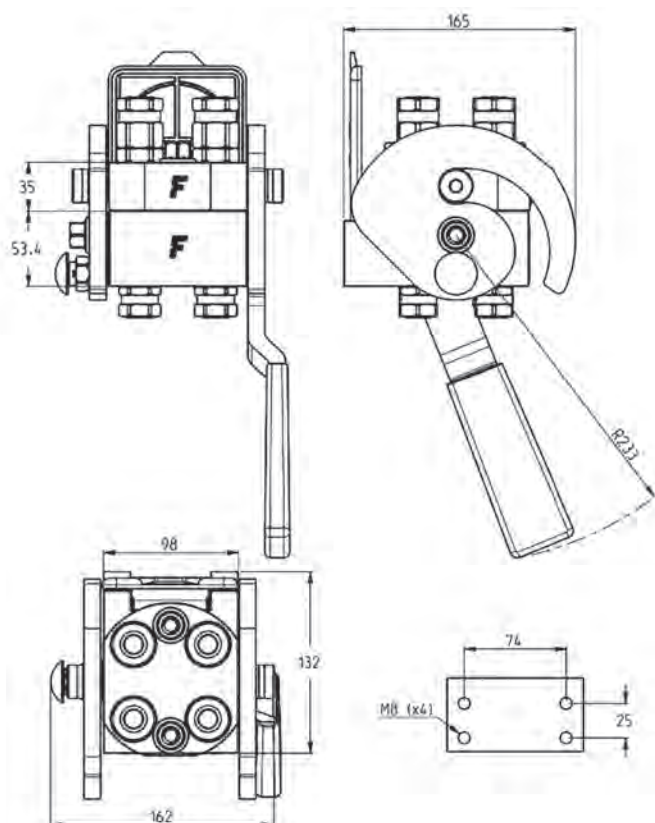

Technical Specifications

dash	Size		Working Pressure (MPa)	Flow Rate (l/min)	Spillage (ml)	Burst pressure (MPa)		
	mm	inch				Male	Female	Male + Female
06	10	3/8"	46	35	0.008	138	138	138

Material	Aluminium; Stainless Steel
Seals	NBR; PUR
Working temperatures	- 25 °C to + 100 °C
Surface treatment	MATE 1000 (ZnNi); Paint

Valve Type	Flat
Connection	Lever
Disconnection	Lever
Connection Under Pressure	Allowed Residual



PH406S

Size					Thread Type					FIXED
dash	mm	inch	Housing	Number of Couplings	Thread Type	Standard	Thread	Electrical Connector N	Connector Type	Part Number
06	10	3/8"	4	4	F BSPP	ISO 1179-1	BSPP 3/8" FEMALE			PH406S-4-38G F C
06	10	3/8"	4	4	03/ METRIC	ISO 8434-1-S	M20x1.5 MALE 12S			PH406-4-A F C*
06	10	3/8"	4	4	F BSPP	ISO 1179-1	BSPP 3/8" FEMALE			PH406-4-38G F C*

Size					Thread Type					MOBILE
dash	mm	inch	Housing	Number of Couplings	Thread Type	Standard	Thread	Electrical Connector N	Connector Type	Part Number
06	10	3/8"	4	4	F BSPP	ISO 1179-1	BSPP 3/8" FEMALE			3PH406S-4-38G M C
06	10	3/8"	4	4	03/ METRIC	ISO 8434-1-S	M20x1.5 MALE 12S			3PH406-4-A M C*
06	10	3/8"	4	4	F BSPP	ISO 1179-1	BSPP 3/8" FEMALE			3PH406-4-38G MC*

*Red paint plates with stainless steel handle and cams version.

Spare Parts & Accessories

PH406

Female Half				Male Half					
Plates	Lever	Dust cover	Safety Lock	Plates	Seals male	Screws	Plugs	Guiding pins	Docking
KIT PH406 F L		KIT TA PH406	KIT SP5 7	KIT PH406 M	SK MF 38	KIT VPH	KIT TSP 12 M	KIT GPH	

PH406S

Female Half				Male Half					
Plates	Lever	Dust cover	Safety Lock	Plates	Seals male	Screws	Plugs	Guiding pins	Docking
		KIT TA PH406				KIT VPH			





MF PH408S

MultiFaster, high pressure version, 4 lines size 08.

New multi-connection system specifically designed to withstand high pressure applications (42 MPa). Equipped with 4 lines size 08. Black cataphoresis plates with Zn-Ni plated carbon steel handle and cams or red paint plates with stainless steel handle and cams.



Applications

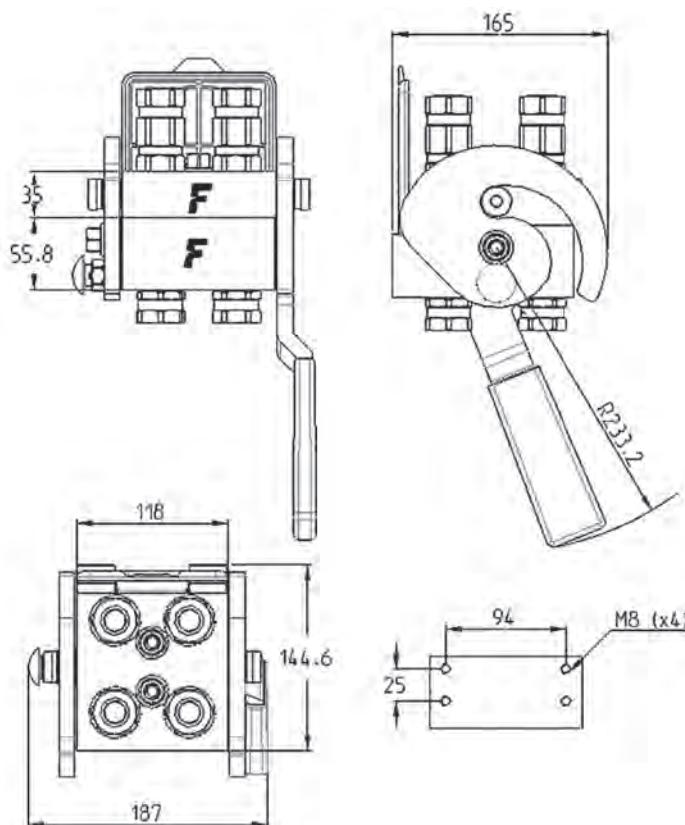

Technical Specifications

dash	Size mm	inch	Working Pressure (MPa)	Flow Rate (l/min)	Spillage (ml)	Burst pressure (MPa)		
						Male	Female	Male + Female
08	12.5	1/2"	46	60	0.01	138	138	138

Material	Aluminium; Stainless Steel
Seals	NBR; PUR
Working temperatures	- 25 °C to + 100 °C
Surface treatment	MATE 1000 (ZnNi); Paint

Valve Type	Flat
Connection	Lever
Disconnection	Lever
Connection Under Pressure	Allowed Residual



PH408S

Size					Thread Type					FIXED
dash	mm	inch	Housing	Number of Couplings	Thread Type	Standard	Thread	Electrical Connector N	Connector Type	Part Number
08	12.5	1/2"	4	4	F BSPP	ISO 1179-1	BSPP 1/2" FEMALE			PH408S-4-12G F C
08	12.5	1/2"	4	4	F BSPP	ISO 1179-1	BSPP 1/2" FEMALE			PH408-4-12G F C*

Size					Thread Type					MOBILE
dash	mm	inch	Housing	Number of Couplings	Thread Type	Standard	Thread	Electrical Connector N	Connector Type	Part Number
08	12.5	1/2"	4	4	F BSPP	ISO 1179-1	BSPP 1/2" FEMALE			3PH408S-4-12G M C
08	12.5	1/2"	4	4	F BSPP	ISO 1179-1	BSPP 1/2" FEMALE			3PH408-4-12G MC*

*Red paint plates with stainless steel handle and cams version.

Spare Parts & Accessories

PH408

Female Half				Male Half					
Plates	Lever	Dust cover	Safety Lock	Plates	Seals male	Screws	Plugs	Guiding pins	Docking
KIT PH408 F L		KIT TA PH408	KIT SP5 7	KIT PH408 M	SK MF 12	KIT VPH	KIT TSP 38 M	KIT GPH	

PH408S

Female Half				Male Half					
Plates	Lever	Dust cover	Safety Lock	Plates	Seals male	Screws	Plugs	Guiding pins	Docking
		KIT TA PH408				KIT VPH			

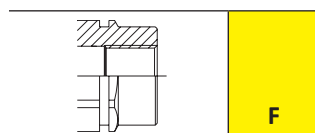

MF PH510S



MultiFaster, high pressure version, 2 lines size 08, 2 lines size 12.

New multi-connection system specifically designed to withstand high pressure applications (42 MPa). Equipped with 2 lines size 08 and 2 lines size 12. Black cathaphoresis plates with Zn-Ni plated carbon steel handle and cams or red paint plates with stainless steel handle and cams.

Applications

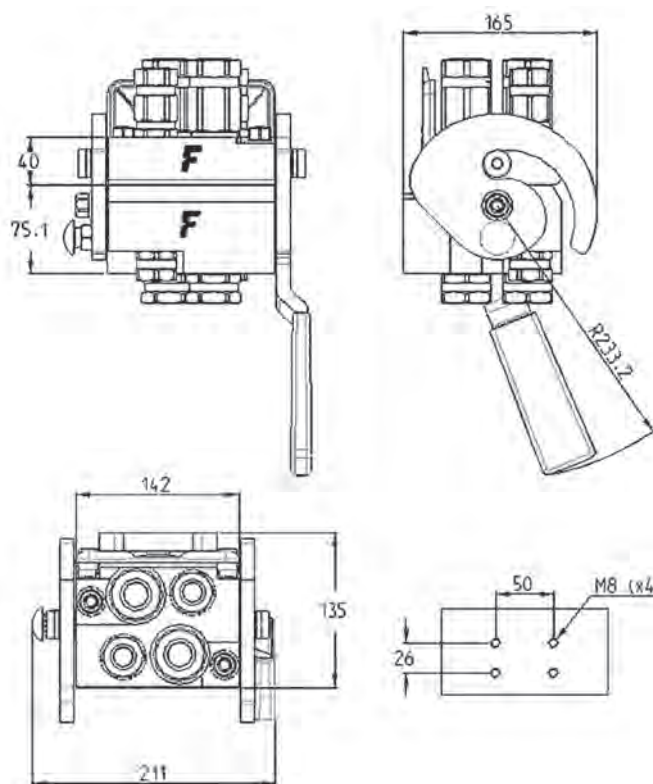

Technical Specifications

dash	Size mm	inch	Working Pressure (MPa)	Flow Rate (l/min)	Spillage (ml)	Burst pressure (MPa)		
						Male	Female	Male + Female
08	12.5	1/2"	46	60	0.01	138	138	138
12	20	3/4"	46	105	0.02	138	138	138

Material	Aluminium; Stainless Steel
Seals	NBR; PUR
Working temperatures	- 25 °C to + 100 °C
Surface treatment	MATE 1000 (ZnNi); Paint

Valve Type	Flat
Connection	Lever
Disconnection	Lever
Connection Under Pressure	Allowed Residual



PH510S

Size					Thread Type					FIXED
dash	mm	inch	Housing	Number of Couplings	Thread Type	Standard	Thread	Electrical Connector N	Connector Type	Part Number
08	12.5	1/2"	4	2	F BSPP	ISO 1179-1	BSPP 1/2" FEMALE			PH510S-3-A F C
08	12.5	1/2"		1	F BSPP	ISO 1179-1	BSPP 1/2" FEMALE			PH510S-4-A F C
12	20	3/4"	4	2	F BSPP	ISO 1179-1	BSPP 3/4" FEMALE			PH510S-3-A F C
12	20	3/4"		2	F BSPP	ISO 1179-1	BSPP 3/4" FEMALE			PH510S-4-A F C
08	12.5	1/2"	4	2	F BSPP	ISO 1179-1	BSPP 1/2" FEMALE			PH510-4-A F C
12	20	3/4"		2	F BSPP	ISO 1179-1	BSPP 3/4" FEMALE			

Size					Thread Type					MOBILE
dash	mm	inch	Housing	Number of Couplings	Thread Type	Standard	Thread	Electrical Connector N	Connector Type	Part Number
08	12,5	1/2"	4	2	F BSPP	ISO 1179-1	BSPP 1/2" FEMALE			3PH510S-4-A M C
08	12,5	1/2"		2	F BSPP	ISO 1179-1	BSPP 1/2" FEMALE			3PH510S-4-B M C
08	12,5	1/2"	4	1	F BSPP	ISO 1179-1	BSPP 1/2" FEMALE			3PH510S-3-A M C
12	20	3/4"		2	F BSPP	ISO 1179-1	BSPP 3/4" FEMALE			3PH510S-4-A M C
12	20	3/4"	4	2	F BSPP	ISO 1179-1	BSPP 3/4" FEMALE			3PH510S-4-B M C
12	20	3/4"		2	F BSPP	ISO 1179-1	BSPP 3/4" FEMALE			3PH510S-3-A M C
08	12.5	1/2"	4	2	F BSPP	ISO 1179-1	BSPP 1/2" FEMALE			3PH510-4-A M C
12	20	3/4"		2	F BSPP	ISO 1179-1	BSPP 3/4" FEMALE			

Spare Parts & Accessories

PH510

Female Half				Male Half					
Plates	Lever	Dust cover	Safety Lock	Plates	Seals male	Screws	Plugs	Guiding pins	Docking
KIT PH510 F L		KIT TA PH510	KIT SP5 7	KIT PH510 M	SK MF 12	KIT VPH	KIT TSP 38 M	KIT GPH	
					SK MF 34		KIT TSP 34 M		

PH510S

Female Half				Male Half					
Plates	Lever	Dust cover	Safety Lock	Plates	Seals male	Screws	Plugs	Guiding pins	Docking
		KIT TA PH510				KIT VPH			

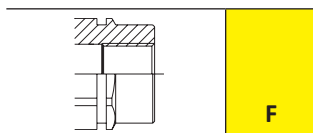

Accessories and Spares for MultiFaster

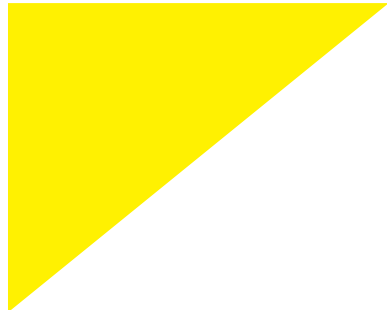

Couplings for MultiFaster

Couplings for MultiFaster - Standard	page 381
Couplings for MultiFaster - Harvesting	page 384
Couplings for MultiFaster - G-Type	page 385
Couplings for MultiFaster - High Pressure	page 386
Couplings for Grease Line	page 387

Accessories and Spares for Fixed Half

Fixed plates	page 389
Levers	page 392
Dust protections	page 394
Safety locks	page 395
Electrical connectors	page 396

Accessories and Spares for Mobile Half

Mobile plates	page 399
Electrical connectors	page 402
Seals	page 403
Screws	page 404
Plugs	page 405
Guiding pins	page 406
Docking systems	page 407

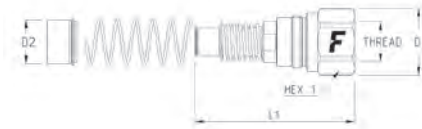

Couplings for MF Standard

Size			Thread Details			COUPLINGS FOR FIXED PLATE						Available for series	
dash	mm	inch	Thread Type	Standard	Thread	Part Number	L1 (L1+ thread) mm	inch	D1 mm	inch	HEX 1 mm	inch	Available for series
04	6.3	1/4"	F BSPP	ISO 1179-1	BSPP 1/4" FEMALE	KIT2FNB14GAS F	57.9	2.3	26	1	24	0.9	P1004 - P10A - P12A - P1504 - P5065
04	6.3	1/4"	O/ SAE	ISO 11926-1	9/16" - 18 UNF FEMALE ORB	KIT2FNB14-38SF	57.8	2.3	26	1	24	0.9	P1004 - P10A - P5065 - P10A
04	6.3	1/4"	13/ SAE	ISO 8434-2	1/2" - 20 UNF 2A MALE JIC	KIT2FNB1413/DSF	68.9	2.7	26	1	24	0.9	P404
06	10	3/8"	F NPTF	ANSI B1.20.3	NPTF 3/8" FEMALE	KIT2FNB38NPT F	72.7	2.9	30	1.2	27	1.1	P206 - P306 - P506 - P606 - PS06
06	10	3/8"	O/ SAE	ISO 11926-1	9/16" - 18 UNF FEMALE ORB	KIT2FNB38-38SF	72.7	2.9	30	1.2	27	1.1	P206 - P306 - P506 - PB06
06	10	3/8"	03/ METRIC	ISO 8434-1-S	M20x1.5 MALE	KIT2FNB38-3/20F	75.7	3	30	1.2	27	1.1	P506
06	10	3/8"	02/ METRIC	ISO 8434-1-L	M18x1.5	KIT2FNB38-2/18F	72.5	2.9	30	1.2	27	1.1	P206 - P406A - P506 P5065 - P606 - PB06 - PS06
06	10	3/8"	16/ BSPP	ISO 8434-6	60° 3/8 BSPP MALE	KIT2FNB3816/38F	80.8	3.2	30	1.2	27	1.1	P206 - P506 - P606 - PB06
06	10	3/8"	16/ BSPP	ISO 8434-6	60° 1/2 BSPP MALE	KIT2FNB3816/12G	74.3	2.9	30	1.2	27	1.1	P306 - P506 - PB06
06	10	3/8"	F NPTF	ANSI B1.20.3	NPTF 1/2" FEMALE	KIT2FNB38-12NF	75.5	3	30	1.2	27	1.1	P206 - P506 - P606 - PS06
06	10	3/8"	11/ SAE	ISO 8434-3	13/16"-16 UN MALE ORFS	KIT2FNB3811/12S	81.7	3.2	30	1.2	27	1.1	P306 - P406 - P506 - PB06 - PS06
06	10	3/8"	O/ SAE	ISO 11926-1	3/4" - 16 UNF FEMALE ORB	KIT2FNB38-12SF	74.3	2.9	30	1.2	27	1.1	P206 - P505 - P506 - P5065 - P5066 P5068 - P508 - P606 - PS06
06	10	3/8"	F BSPP	ISO 1179-1	BSPP 1/2" FEMALE	KIT2FNB38-12GF	74.3	2.9	30	1.2	27	1.1	P206 - P306 - P506 - P5065 - P5066 P5068 - P606 - PB06 - PS06
06	10	3/8"	F BSPP	ISO 1179-1	BSPP 3/8" FEMALE	KIT2FNB38GASF	72.5	2.9	30	1.2	27	1.1	P206 - P306 P506 - P5066 - P5068 P606 - PB06 - PS06 - P306
06	10	3/8"	02/ METRIC	ISO 8434-1-L	M22x1.5 MALE	KIT2FNB38-2/22F	73.5	2.9	30	1.2	27	1.1	P206 - P506 - P606 - PB06 - P306 PS06
08	12.5	1/2"	F NPTF	ANSI B1.20.3	NPTF 1/2" FEMALE	KIT2FNB12NPT F	81	3.2	33	1.3	30	1.2	P208 - P306 - P508 - P510 - P608 P808 - PS08
08	12.5	1/2"	O/ SAE	ISO 11926-1	1 - 1/16" - 12 UN FEMALE ORB	KIT2FNB12-34SF	88	3.5	38	1.5	34	1.3	P10A - P208 - P508 - P608 - P808 P10A
08	12.5	1/2"	F BSPP	ISO 1179-1	BSPP 3/4" FEMALE	KIT2FNB12-34GF	84.2	3.3	38	1.5	34	1.3	P10A - P208 - P508 - P510 - P608 P808
08	12.5	1/2"	03/ METRIC	ISO 8434-1-S	M24x1.5 MALE	KIT2FNB12-3/24F	86	3.4	33	1.3	30	1.2	P12A - P508 - P510 - P608 - P808 P510
08	12.5	1/2"	02/ METRIC	ISO 8434-1-L	M22x1.5 MALE	KIT2FNB12-2/22F	84	3.3	33	1.3	30	1.2	P208 - P506 - P508 - P510 P608 - P808 - PS08
08	12.5	1/2"	02/ METRIC	ISO 8434-1-L	M18x1.5 MALE	KIT2FNB12-2/18F	83	3.3	33	1.3	30	1.2	P508 - P608 - P808
08	12.5	1/2"	O/ SAE	ISO 11926-1	3/4" - 16 UNF FEMALE ORB	KIT2FNB12-12SF	81	3.2	33	1.3	30	1.2	P10A - P12A - P208 - P306 - P506 P508 - P510 - P608 - P808
08	12.5	1/2"	11/ SAE	ISO 8434-3	13/16"-16 UN MALE ORFS	KIT2FNB1211/12S	84.8	3.3	33	1.3	30	1.2	P208 - P506 - P508 - P608 - P808
08	12.5	1/2"	F BSPP	ISO 1179-1	BSPP 1/2" FEMALE	KIT2FNB12GAS F	80.8	3.2	33	1.3	30	1.2	P10A - P12A - P208 - P306 - P506 P508 - P510 - P608 - P808 - PS08
08	12.5	1/2"	F BSPP	ISO 1179-1	BSPP 1/2" FEMALE	KIT2FNB12G F2V*	81	3.2	33	1.3	30	1.2	P12A - P12B - P508
12	20	3/4"	O/ SAE	ISO 11926-1	1 - 1/16" - 12 UN FEMALE ORB	KIT2FNB34-34SF	100.7	4	47	1.9	42	1.6	P510 - P412
12	20	3/4"	F BSPP	ISO 1179-1	BSPP 1" FEMALE	KIT2FNB34-1GF	100.9	4	47	1.9	42	1.6	P510
12	20	3/4"	F BSPP	ISO 1179-1	BSPP 3/4" FEMALE	KIT2FNB34GAS F	100.6	4	47	1.9	42	1.6	P510 - P412
16	25	1"	F BSPP	ISO 1179-1	BSPP 1" FEMALE	KIT2FNB1 GAS F	99.9	3.9	55	2.2	50	2	P316

* Couplings in Stainless Steel and seals in FKM.

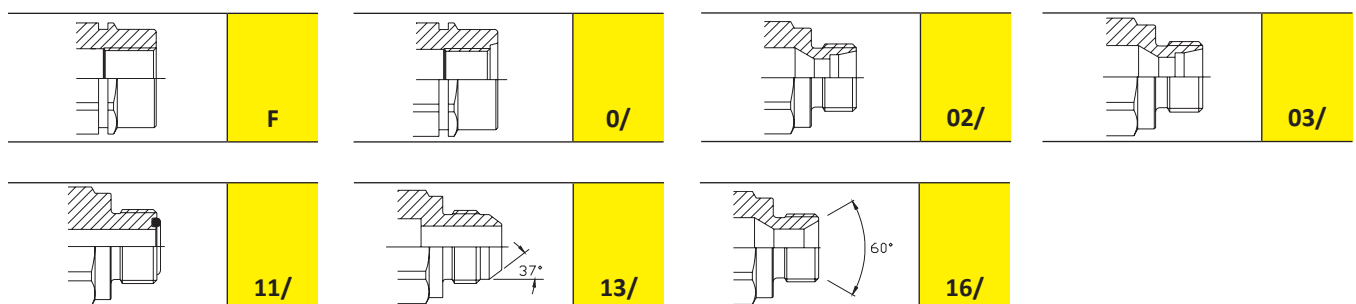

Couplings for MF Standard

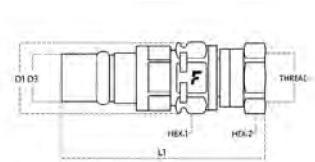

Size			Thread Details			COUPLINGS FOR MOBILE PLATE								Available for series
dash	mm	inch	Thread Type	Standard	Thread	Part Number	Pressure eliminator	L1 (L1+ thread)		HEX 1		D3		
								mm	inch	mm	inch	mm	inch	
04	6.3	1/4"	F BSPP	ISO 1179-1	BSPP 1/4" FEMALE	KIT3FNP14GAS MS	YES	111.6	4.4	27	1.1	16.1	0.6	P10A - P5065
04	6.3	1/4"	O/ SAE	ISO 11926-1	9/16"-18 UNF FEMALE ORB	KIT3FNP14-38SMC	YES	113.0	4.4	27	1.1	16.1	0.6	P5065
04	6.3	1/4"	F BSPP	ISO 1179-1	BSPP 1/4" FEMALE	KIT2FNP14GAS M	NO	71.3	2.8	24	0.9	16.1	0.6	P1004 - P12A P1504 - P404
04	6.3	1/4"	O/ SAE	ISO 11926-1	9/16" - 18 UNF FEMALE ORB	KIT2FNP14-38SM	NO	72.8	2.9	24	0.9	16.1	0.6	P1004 - P10A P404 - P5065
04	6.3	1/4"	20/ BSPP	BS 5200	BSPP 3/8 FEMALE	KIT2FNP1420/38G	NO	76.6	3	24	0.9	16.1	0.6	P404
06	10	3/8"	F BSPP	ISO 1179-1	BSPP 3/8" FEMALE	KIT3FNP38GAS M	YES	107.3	42.2	27	1.1	19.6	0.8	P206 - P306 - P506 P5066 - P5068 - P606 P506
06	10	3/8"	O/ SAE	ISO 11926-1	9/16" - 18 UNF FEMALE ORB	KIT3FNP38-38SM	YES	108.3	4.3	27	1.1	19.6	0.8	P306 - P506
06	10	3/8"	03/ METRIC	ISO 8434-1-S	M20x1.5 MALE	KIT3FNP38-3/20M	YES	108.5	4.3	27	1.1	19.6	0.8	P506
06	10	3/8"	20/ BSPP	BS 5200	BSPP 1/2 FEMALE	KIT3FNP3820/12G	YES	117.4	4.6	27	1.1	19.6	0.8	P506 - PB06
06	10	3/8"	02/ METRIC	ISO 8434-1-L	M22x1.5 MALE	KIT3FNP38-2/22M	YES	108.5	4.3	27	1.1	19.6	0.8	P206 - P506 - PS06
06	10	3/8"	O/ SAE	ISO 11926-1	3/4" - 16 UNF FEMALE ORB	KIT3FNP38-12SM	YES	108.4	4.3	27	1.1	19.6	0.8	P206 - P506 - P5065 P606 - PB06
06	10	3/8"	F BSPP	ISO 1179-1	BSPP 1/2" FEMALE	KIT3FNP38-12GM	YES	108.3	4.3	27	1.1	19.6	0.8	P206 - P306 - P506 P5065 - P5068 - P606 PB06 - PS06
06	10	3/8"	11/ SAE	ISO 8434-3	13/16"-16 UN MALE ORFS	KIT3FNP3811/12S	YES	109.8	4.3	27	1.1	19.6	0.8	P306 - P506 - PB06
06	10	3/8"	O/ SAE	ISO 11926-1	9/16" - 18 UNF FEMALE ORB	KIT2FNP38-38SM	NO	77.3	3	27	1.1	19.6	0.8	P206 - P506
06	10	3/8"	03/ METRIC	ISO 8434-1-S	M20x1.5 MALE	KIT2FNP38-3/20M	NO	78.3	3.1	27	1.1	19.6	0.8	P506
06	10	3/8"	20/ BSPP	BS 5200	BSPP 1/2 FEMALE	KIT2FNP3820/12G	NO	88.7	3.5	27	1.1	19.6	0.8	P506 - PB06 - PS06 P5066
06	10	3/8"	02/ METRIC	ISO 8434-1-L	M18x1.5 MALE	KIT2FNP38-2/18M	NO	78.45	3.1	27	1.1	19.6	0.8	P206 - P506 - P5065 P606 - PS06
06	10	3/8"	16/ BSPP	ISO 8434-6	60° 3/8 BSPP MALE	KIT2FNP3816/38G	NO	79.8	3.1	27	1.1	19.6	0.8	P506 - P606 - PS06
06	10	3/8"	O/ SAE	ISO 11926-1	3/4" - 16 UNF FEMALE ORB	KIT2FNP38-12SM	NO	81.3	3.2	27	1.1	19.6	0.8	P506 - P5066 - P5068 P606 - P606S - PS06
06	10	3/8"	F NPTF	ANSI B1.20.3	NPTF 1/2" FEMALE	KIT2FNP38-12NM	NO	81.3	3.2	27	1.1	19.6	0.8	P206 - P506 - P606 PB06 - PS06
06	10	3/8"	11/ SAE	ISO 8434-3	13/16"-16 UN MALE ORFS	KIT2FNP3811/12S	NO	79.1	3.1	27	1.1	19.6	0.8	P306 - PS06
06	10	3/8"	F BSPP	ISO 1179-1	BSPP 1/2" FEMALE	KIT2FNP38-12GM	NO	81.3	3.2	27	1.1	19.6	0.8	P206 - P306 - P506 P5066 - P5068 - P606 PB06 - PS06
06	10	3/8"	F BSPP	ISO 1179-1	BSPP 3/8" FEMALE	KIT2FNP38GASM	NO	77.3	3	27	1.1	19.6	0.8	P206 - P306 - P506 P5066 - P5068 - P606 PB06 - PS06
06	10	3/8"	02/ METRIC	ISO 8434-1-L	M22x1.5 MALE	KIT2FNP38-2/22M	NO	78.3	3.1	27	1.1	19.6	0.8	P206 - P506 - P606 PB06 - PS06
06	10	3/8"	16/ BSPP	ISO 8434-6	60° 1/2" BSPP MALE	KIT2FNP3816/12G	NO	80.3	3.2	27	1.1	19.6	0.8	P306
08	12.5	1/2"	F BSPP	ISO 1179-1	BSPP 1/2" FEMALE	KIT3FNP12GAS M	YES	121.1	4.8	34	1.3	24.9	1.0	P208 - P506
08	12.5	1/2"	O/ SAE	ISO 11926-1	1 - 1/16" - 12 UN FEMALE ORB	KIT3FNP12-34SM	YES	122.7	4.8	34	1.3	24.9	1.0	P10A - P208
08	12.5	1/2"	02/ METRIC	ISO 8434-1-L	M22x1.5 MALE	KIT3FNP12-2/22M	YES	119	4.7	34	1.3	24.9	1.0	P508 - P608 - P808
08	12.5	1/2"	O/ SAE	ISO 11926-1	3/4" - 16 UNF FEMALE ORB	KIT3FNP12-12SM	YES	120.7	4.6	34	1.3	24.9	1.0	P10A - P12A - P208 P306 - P506 - P508 P808
08	12.5	1/2"	11/ SAE	ISO 8434-3	13/16"-16 UN MALE ORFS	KIT3FNP1211/12S	YES	119.7	4.7	34	1.3	24.9	1.0	P208 - P506 - P508 P608 - P808
08	12.5	1/2"	F NPTF	ANSI B1.20.3	NPTF 1/2" FEMALE	KIT2FNP12NPT M	NO	87	3.4	32	1.2	24.9	1.0	P510
08	12.5	1/2"	O/ SAE	ISO 11926-1	1 - 1/16" - 12 UN FEMALE ORB	KIT2FNP12-34SM	NO	92	3.6	34	1.3	24.9	1.0	P10A - P208 - P508 P608 - P808
08	12.5	1/2"	F BSPP	ISO 1179-1	BSPP 3/4" FEMALE	KIT2FNP12-34GM	NO	92	3.6	34	1.3	24.9	1.0	P10A - P208 - P508 P510 - P608 - P808

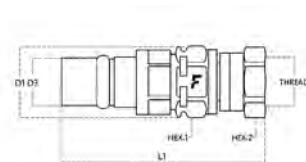

Couplings for MF Standard

Size			Thread Details			COUPLINGS FOR MOBILE PLATE								Available for series
dash	mm	inch	Thread Type	Standard	Thread	Part Number	Pressure eliminator	L1 (L1+ thread)		D3		HEX 1		
								mm	inch	mm	inch	mm	inch	
08	12.5	1/2"	03/ METRIC	ISO 8434-1-S	M24x1.5 MALE	KIT2FNP12-3/24M	NO	87.7	3.5	32	1.2	24.9	1.0	P12A - P508 - P510 P608
08	12.5	1/2"	02/ METRIC	ISO 8434-1-L	M22x1.5 MALE	KIT2FNP12-2/22M	NO	85.7	3.4	32	1.2	24.9	1.0	P208 - P506 - P508 P510 - P608 - P808 PS08 - P506
08	12.5	1/2"	02/ METRIC	ISO 8434-1-L	M18x1.5 MALE	KIT2FNP12-2/18M	NO	109.5	4.3	32	1.2	24.9	1.0	P208 - P508
08	12.5	1/2"	0/ SAE	ISO 11926-1	3/4" - 16 UNF FEMALE ORB	KIT2FNP12-12SM	NO	87	3.4	32	1.2	24.9	1.0	P12A - P208 - P508 P510 - P608 - P808
08	12.5	1/2"	11/ SAE	ISO 8434-3	13/16"-16 UN MALE ORFS	KIT2FNP1211/12S	NO	86.7	3.4	32	1.2	24.9	1.0	P208 - P508 - P608 P808 - P608
08	12.5	1/2"	F BSPP	ISO 1179-1	BSPP 1/2" FEMALE	KIT2FNP12GAS M	NO	87	3.4	32	1.2	24.9	1.0	P12A - P208 - P506 P508 - P510 - P608 P808 - PS08
08	12.5	1/2"	F BSPP	ISO 1179-1	BSPP 1/2" FEMALE	KIT2FNP12G M2V*	NO	90	3.5	32	1.2	24.9	1.0	P12A - P12B - P508
12	20	3/4"	F BSPP	ISO 1179-1	BSPP 3/4" FEMALE	KIT3FNP34GAS M	YES	132.85	5.2	42	1.6	29.9	1.2	P412 - P510
12	20	3/4"	0/ SAE	ISO 11926-1	1 - 1/16" - 12 UN FEMALE ORB	KIT3FNP34-34SM	YES	132.9	5.2	42	1.6	29.9	1.2	P412 - P510
12	20	3/4"	F BSPP	ISO 1179-1	BSPP 3/4" FEMALE	KIT2FNP34GAS M	NO	106.5	4.2	41	1.6	29.9	1.2	P510
12	20	3/4"	0/ SAE	ISO 11926-1	1 - 1/16" - 12 UN FEMALE ORB	KIT2FNP34-34SM	NO	104.9	41.3	41	1.6	29.9	1.2	P510
16	25	1"	F BSPP	ISO 1179-1	BSPP 1" FEMALE	KIT3FNP1 GAS M	YES	146.7	5.8	50	2	36	1.4	P316

* Couplings in Stainless Steel and seals in FKM.

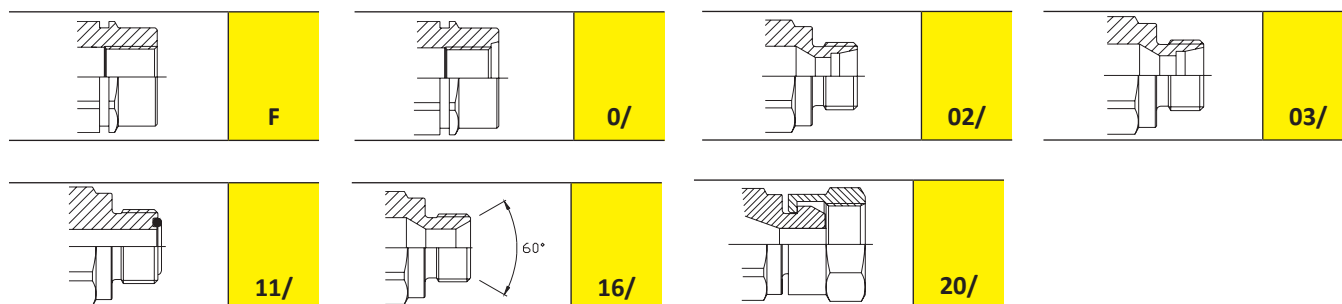

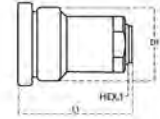

Couplings for MF Harvesting

Size			Thread Details			COUPLINGS FOR FIXED PLATE							Available for series
dash	mm	inch	Thread Type	Standard	Thread	Part Number	L1 (L1+ thread)		D1		HEX 1		
							mm	inch	mm	inch	mm	inch	
06	10.0	3/8"	11/ SAE	ISO 8434-3	11/16"-16 UN MALE ORFS	KIT 2FFC06 F	90	3.5	37	1.5	34	1.3	PLV
06	10.0	3/8"	11/ SAE	ISO 8434-3	11/16"-16 UN MALE ORFS	KIT 2FFB06 F	55	2.2	39.5	1.6	24	0.9	PLK
09	14.3	9/16"	11/ SAE	ISO 8434-3	11/16"-16 UN MALE ORFS	KIT 2FFBS09 F	59	2.3	39.5	1.6			PLK
09	14.3	9/16"	11/ SAE	ISO 8434-3	13/16"-16 UN MALE ORFS	KIT 2FFB09 F	59	2.3	39.4	1.6			PLV

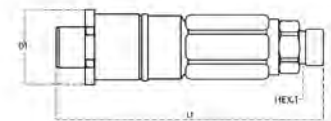

Size			Thread Details			COUPLINGS FOR MOBILE PLATE							Available for series	
dash	mm	inch	Thread Type	Standard	Thread	Part Number	Pressure eliminator	L1 (L1+ thread)		D1		HEX 1		
								mm	inch	mm	inch	mm	inch	
06	10.0	3/8"	11/ SAE	ISO 8434-3	11/16"-16 UN MALE ORFS	KIT3FFP0611/38S	YES	129	5.1	36	1.4	22	0.9	PLK - PLV
06	10.0	3/8"	0/ SAE	ISO 11926-1	3/4"-16 UNF FEMALE ORB	KIT3FFP06-12S M	YES	108	4.3	36	1.4	27	1.1	PLK - PLV
09	14.3	9/16"	11/ SAE	ISO 8434-3	13/16"-16 UN MALE ORFS	KIT3FFP0911/12S	YES	157	6.2	36	1.4	27	1.1	PLK - PLV
09	14.3	9/16"	11/ SAE	ISO 8434-3	11/16"-16 UN MALE ORFS	KIT3FFP0911/38S	YES	155	6.1	36	1.4	27	1.1	PLK
09	14.3	9/16"	11/ SAE	ISO 8434-3	1"-14 UNS MALE ORFS	KIT3FFP0911/58S	YES	159	6.3	36	1.4	27	1.1	PLK - PLV
09	14.3	9/16"	0/ SAE	ISO 11926-1	7/8"-14 UNF FEMALE ORB	KIT3FFP09-58S M	YES	132	5.2	36	1.4	29	1.1	PLK - PLV

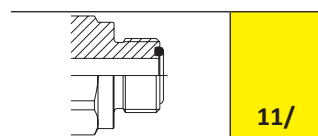
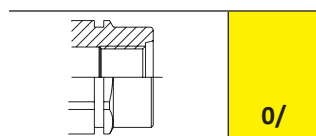

Couplings for MF G-Type

Couplings with surface treatment in Zinc-Nickel

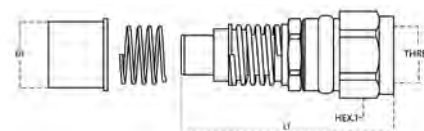

Size			Thread Details			COUPLINGS FOR FIXED PLATE						Available for series	
dash	mm	inch	Thread Type	Standard	Thread	Part Number	L1 (L1+ thread)		HEX 1		D1		
							mm	inch	mm	inch	mm	inch	
06	10	3/8"	F BSPP	ISO 1179-1	BSPP 1/2" FEMALE	KIT2FNB38-12GF7	74.3	2.9	19.7	0.8	27	1.1	P206G - P506G
08	12.5	1/2"	F BSPP	ISO 1179-1	BSPP 1/2" FEMALE	KIT2FNB12GAS F7	81	3.2	33	1.3	30	1.2	P208G - P508G - P510G P608G
08	12.5	1/2"	03/ METRIC	ISO 8434-1-S	M24x1.5 MALE	KIT2FNB12-3/247	86	3.4	33	1.3	30	1.2	P608G
12	20	3/4"	F BSPP	ISO 1179-1	BSPP 3/4" FEMALE	KIT2FNB34GAS F7	100.7	4	47	1.9	42	1.6	P510G

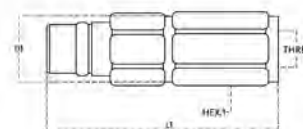

Size			Thread Details			COUPLINGS FOR MOBILE PLATE						Available for series		
dash	mm	inch	Thread Type	Standard	Thread	Part Number	Pressure eliminator	L1 (L1+ thread)		D1		HEX 1		
								mm	inch	mm	inch	mm	inch	
06	10	3/8"	F BSPP	ISO 1179-1	BSPP 1/2" FEMALE	KIT3FNP38-12GM7	YES	108	4.3	27	1.1	19.6	0.8	P206G - P506G
08	12.5	1/2"	F BSPP	ISO 1179-1	BSPP 1/2" FEMALE	KIT3FNP12GAS M7	YES	121.1	4.8	34	1.3	24.9	1.0	P208G - P50G P510G - P508G
08	12.5	1/2"	03/ METRIC	ISO 8434-1-S	M24x1.5 MALE	KIT3FNP123/24S7	YES	120.9	4.8	34	1.3	24.9	1.0	P608G
12	20	3/4"	F BSPP	ISO 1179-1	BSPP 3/4" FEMALE	KIT3FNP34GAS M7	YES	132.9	5.2	42	1.6	29.9	1.2	P510G

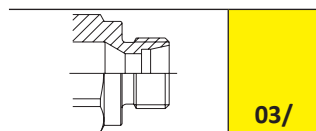
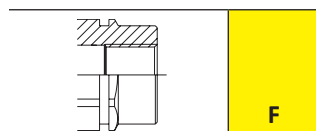

Couplings for MF High Pressure

Couplings with surface treatment in Zinc-Nickel

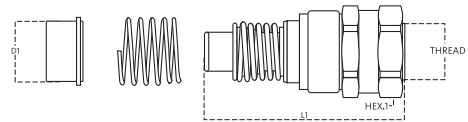

Size			Thread Details			COUPLINGS FOR FIXED PLATE								Available for series
dash	mm	inch	Thread Type	Standard	Thread	Part Number	L1 (L1+ thread)		D1		HEX 1			
							mm	inch	mm	inch	mm	inch		
06	10	3/8"	F BSPP	ISO 1179-1	BSPP 3/8" FEMALE	KITFHB06-38GF	75	3	30	1.2	30	1.2	PH	
08	12,5	1/2"	F BSPP	ISO 1179-1	BSPP 1/2" FEMALE	KITFHB08-12GF	80,5	3,2	37	1,5	37	1,5	PH	
12	20	3/4"	F BSPP	ISO 1179-1	BSPP 3/4" FEMALE	KITFHB12-34GF	100	3,9	47	1,9	42	1,6	PH	
16	25	1"	F BSPP	ISO 1179-1	BSPP 1" FEMALE	KITFHB16-1GF	99,8	3,9	55	2,2	55	2,1	PH	

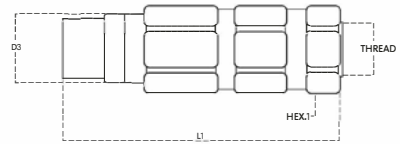

Size			Thread Details			COUPLINGS FOR MOBILE PLATE								Available for series
dash	mm	inch	Thread Type	Standard	Thread	Part Number	Pressure eliminator	L1 (L1+ thread)		D3		HEX 1		
								mm	inch	mm	inch	mm	inch	
06	10	3/8"	F BSPP	ISO 1179-1	BSPP 3/8" FEMALE	KIT3FHP06-38GM	YES	96.4	3.8	19.6	0.8	30	1.2	PH
08	12.5	1/2"	F BSPP	ISO 1179-1	BSPP 1/2" FEMALE	KIT3FHP08-12GM	YES	115.7	4.6	24.9	1.0	34	1.3	PH
12	20	3/4"	O/ BSPP	BS 5380	BSPP 3/4 FEMALE ORB	KIT3FHP12-34GM	YES	129	5.1	29.9	1.2	42	1.6	PH
16	25	1"	F BSPP	ISO 1179-1	BSPP 1" FEMALE	KIT3FHP16-1GM	YES	145	5.7	36	1.4	34	1.3	PH

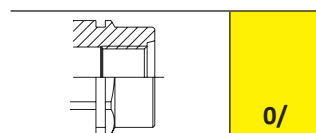
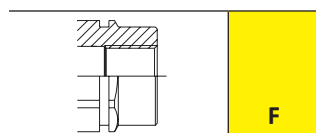

Couplings for MF Grease Line

A 1/2" grease coupling that can be installed on any MultiFaster.

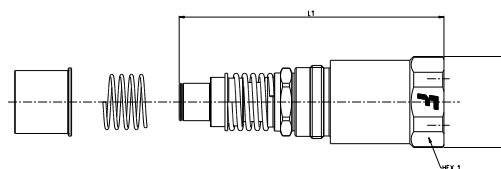

Size			Thread Details						COUPLINGS FOR FIXED PLATE						
dash	mm	inch	Thread Type	Standard	Thread	Thread type	Standard	Thread	Part Number	L1 (L1+ thread)		D1		HEX 1	
										mm	inch	mm	inch	mm	inch
08	12.5	1/2"	F BSPP	ISO 1179-1	BSPP 1/8" FEMALE	O1/ BSPP	ISO 1179-3	1/4" BSPP MALE	KIT2FNGS12 AAF	104.8	4.13	36	1.42	34	1.34

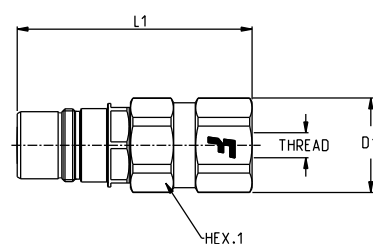

Size			Thread Details			COUPLINGS FOR MOBILE PLATE								
dash	mm	inch	Thread Type	Standard	Thread	Part Number	L1 (L1+ thread)		HEX 1		HEX 1		HEX 2	
							mm	inch	mm	inch	mm	inch	mm	inch
08	12.5	1/2"	F BSPP	ISO 1179-1	BSPP 1/8" FEMALE	KIT2FNP12-18GM	87	3.43	35	1.38	32	1.26	32	1.26

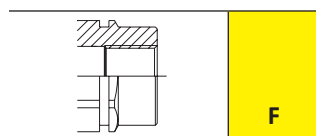

Accessories and Spares for Fixed half

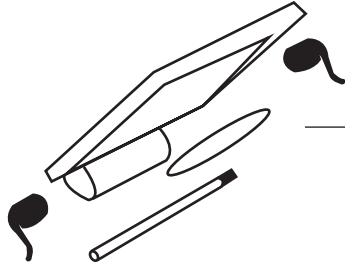

Dust Protections
Page 394

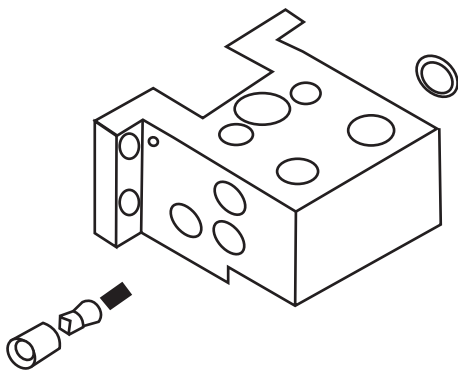

Fixed Plates
Page 389

Safety Locks
Page 395

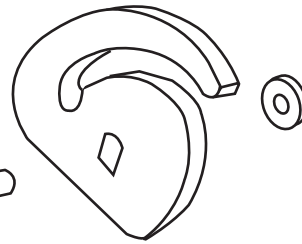

Levers
Page 392

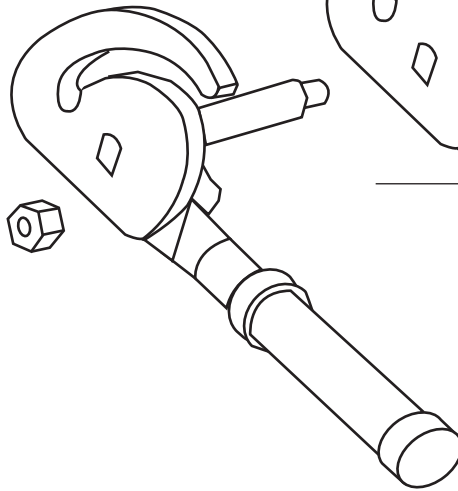

Electrical Connectors
Page 396









Couplings for Fixed Plate
Page 381















Fixed plates

Complete fixed half without couplings.

	Part number	Available for series
	KIT PB06 F L	PB06
	KIT P206 F L	P206
	KIT P208 F L	P208
	KIT P306 F L	P306
	KIT P4A F L	P316
	KIT P506 F L	P506
	KIT P506-1 F L	P506-X
	KIT P508 F L	P508
	KIT P510 F L	P510
	KIT PS06 F L	PS06



Fixed plates

Complete fixed half without couplings.

	Part number	Available for series
	KIT PS08 F L	PS08
	KIT P606 F L	P606
	KIT P608 F L	P608
	KIT P5068 F L	P5068
	KIT P808 F L	P808
	KIT PLV F L	PLV
	KIT PLK F L	PLK
	KIT P5065 F L	P5065
	KIT P506G F L	P506G
	KIT PH406 F L	PH406











Fixed plates

Complete fixed half without couplings.











	Part number	Available for series
	KIT PH408 F L	PH408
	KIT PH510 F L	PH510



Levers

	Part number	Description
	KIT LPB06	PB06
	KIT LP206	P206
	KIT LP208	P208
	KIT LP506	P506
	KIT LP506-1	P506-x
	KIT LP508	P508
	KIT LP510	P510
	KIT LP606	P606 - PS06
	KIT LP608	P608
	KIT LP808	P808

Levers

	Part number	Description
	KIT LP10A	P10A
	KIT LPLV	PLV
	KIT LP206G	P206G
	KIT LP208G	P208G
	KIT LP506G	P506G
	KIT LP508G	P508G
	KIT L3P510	P510
	KIT LP510G	P510G
	KIT LP608G	P608G
	KIT LP808G	P808G



Dust protections

Automatic dust protections to prevent dust and dirt depositing on the fixed half when uncoupled.

	Part number	Available for series
	KIT TA PB06	PB06
	KIT TA P2	P206 - P206G - P208 P208G - P306 - P404
	KIT TA P5	P506 - P5065 - P5066 P5068 - P506G - P508G P510G - P508 - P412
	KIT TA P6	P606 - PS06 - PS08
	KIT TA P608	P608 - P608G
	KIT TA P8	P1004 - P10A - P316 P808 - P808G





Safety locks

	Part number	Available for series
	KIT SP4	P206 - P5068
	KIT SP4 7	P206G
	KIT SP5 S	P206 - P208 - P208G - P306 - P316 P404 - P406A - P506 - P5065 - P5066 P5068 - P508 - P510 - P606 - P608 P808 - PB06 - PS06 - PS08 - P1004 P10A - P12A - P1504 - PB06 - PS06 PS08
	KIT SP5 7	P208G - P506G - P508G - P510G P608G - P808G - PH406 - PH408 PH510
	KIT SP6	PLK



Electrical connectors

	Part number	Number Pins
	KIT SPELO8-3F	3
	KIT SPELO8-7F	7
	KIT SPELM08-7F	7

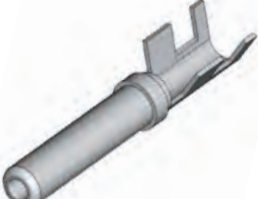
	Part number	Description
	KIT CCSPELO8-7	Cable terminal for 7 poles electrical connector

Accessories and Spares for Mobile half

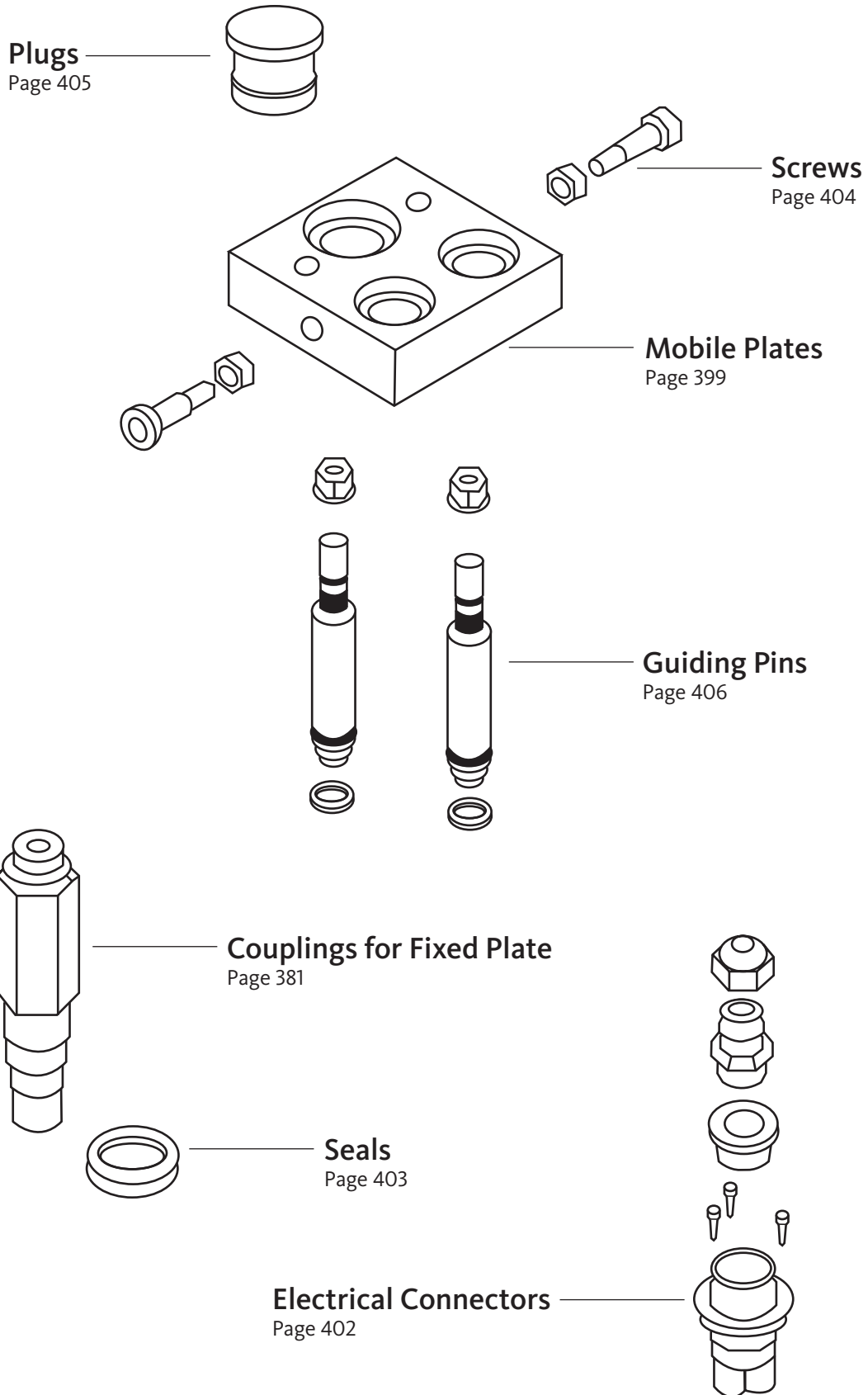









Mobile plates

Complete mobile half without couplings.

	Part number	Available for series
	KIT PB06 M	PB06
	KIT P206 M	P206
	KIT P208 M	P208
	KIT P306 M	P306
	KIT P506 M	P506
	KIT P506-1 M	P506-X
	KIT P508 M	P508
	KIT P510 M	P510
	KIT PS06 M	PS06
	KIT PS06-0 M	PS06-X

Mobile plates

Complete mobile half without couplings.

	Part number	Available for series
	KIT PS08 M	PS08
	KIT P606 M	P606
	KIT P608 M	P608
	KIT P5068 M	P5068
	KIT P808 M	P808
	KIT PLV M	PLV
	KIT PLK M	PLK
	KIT P5065 M	P5065
	KIT PH406 M	PH406
	KIT PH408 M	PH408



Mobile plates

Complete mobile half without couplings.

	Part number	Available for series
	KIT PH510 M	PH510



Electrical connectors

	Part number	Number Pins
	KIT SPELO8-3M	3
	KIT SPELO8-7M	7
	KIT SPELM08-7M	7



Seals









Part number	Available for series	Number of sets	Material
SK MF 14	1/4"	10	PUR
SK MF 38	3/8"	10	PUR
SK MF 12	1/2"	10	PUR
SK MF 916	9/16"	10	PUR
SK MF 34	3/4"	10	PUR
SK MF 1	1"	10	PUR
SK MF 112	1-1/2"	5	PUR

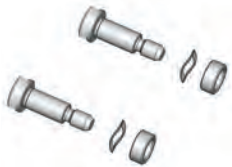

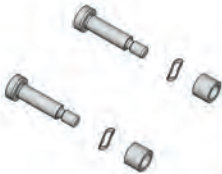
Screws

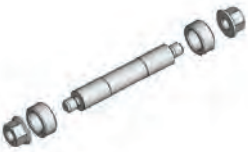
Screws with rollers for mobile half to engage with the cams.

	Part number	Available for series
	KIT VP4	P206 - P506 - P5065 P606 - PS06 - PSA06
	KIT VP4 7	P206G - P506G
	KIT VP8	P1004 - P10A - P12A - P1504 P208 - P306 - P404 - P506 P508 - P510 - P608 - P808 - PS08
	KIT VP8 7	P508G - P510G - P208G - P608G
	KIT VPB06	PB06
	KIT VP116	P316
	KIT VPLK M	PLK - PLV



Plugs

Plugs for the empty housings on the mobile half of the MultiFaster.

	Part number	Available for series
	KIT TSP 38 M	3/8"
	KIT TSP 12 M	1/2"
	KIT TSP 34 M	3/4"
	KIT TPLK 32	Special size for PLV, PLK series



Guiding pins

Pins to guide the connection manoeuvre.

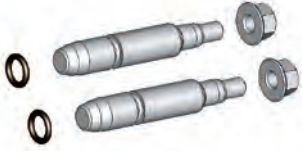
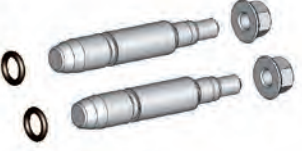
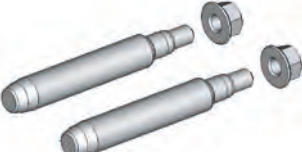
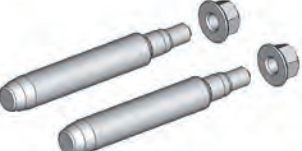
	Part number	Available for series
	KIT GP4	P10A - P12A - P1504 - P206 - P208 P306 - P404 - P406A - P412 - P506 P5065 - P5066 - P5068 - P508 - P510 P606 - P608 - PS06 - PS08
	KIT GP4 7	P208G - P508G - P608G P206G - P506G - P510G
	KIT GP8	P808
	KIT GP8 7	P808G



Docking systems

Docking station to park the mobile half when not in use.

	Part number	Available for series
	S PS	PS06
	S P2	P206 - P208
	S P404	P404
	S P5	P506 - P506-X - P508
	S P510	P510 - P510G
	S P5065	P5065
	S P5068	P5068
	S P6	P606
	S P608	P608 - P608G
	S P8	P808 - P806G
	S PB06	PB06
	S PU	All MultiFaster series

Useful Information

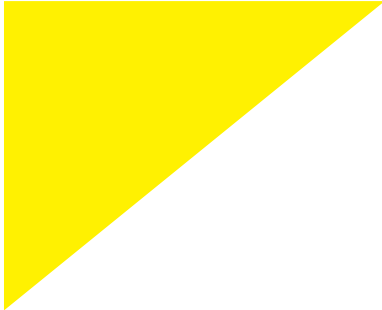

Useful Information

Glossary	page 410
Size & conversion table	page 412
Temperature	page 413
Coupler selection	page 414
Thread Faster - standard	page 415
Fluid compatibility	page 420
Instructions and warnings for couplings	page 422
Instructions and warnings for MultiFaster	page 423

Glossary

Adaptor	Threaded component of a quick release coupling whose function is to allow connection of the coupling to hydraulic system.
Air Inclusion	Air quantity that, being entrapped between the two valves during connection phase, is directly conveyed into the hydraulic plant.
Antiextrusion / back-up ring	Ring-shaped component made of PTFE with quadrilateral section to prevent the extrusion of O-ring seal from its groove when high pressures are reached.
Breakaway	Standard safety feature (ISO 5675) for agricultural machines requiring that the automatic disconnection has to happen whenever, for any reason, an extreme pulling force is applied on the coupling itself. This may be due, for instance, to detachment and dragging of the equipment from the tractor.
Brinelling	Wear phenomenon caused by pressure inside of a quick release coupling. It is due to high loads concentrated on contact point between latching balls and groove on male half.
Connection Force	Value of the effort to perform the connection.
DN - Nominal Diameter	Dimension (in millimetres) of the nominal diameter of a quick release coupling, corresponding to the equivalent flow section.
Double Action Sleeve	Special sleeve (with a double internal balls groove) specifically designed to allow push-pull connection and disconnection. To achieve this kind of connection, the coupling has to be panel mounted.
Dynamic Pressure	Pressure value due to fluid motion in dynamic conditions, such as pressure peaks. In hydraulic circuits it generates fatigue stress on couplers. If added to Static Pressure, it results in Total Pressure of the fluid.
ISO Size	A dimensional number indicating the nominal size according to UNI-ISO 4397 standards.
Max. Working Pressure	Pressure level not to be exceeded for safety reasons. Maximum working pressure derives from the minimum burst pressure applying a suitable safety factor (Faster suggests a 4:1 ratio).

Glossary

Min. Burst pressure	Pressure level at which the quick release coupling damages itself with the consequent loss of functional and safety features. This value is obtained by carrying on burst test activities destroying samples in three situations: male disconnected, female disconnected, coupling connected.
Min. Flow Section	Minimum value of the flow section measured in correspondence with the most narrow passage through the quick release coupling.
Peak Pressure	Pressure value that is reached in a very short time and in non steady state.
Pressure Drop (Δp)	The difference between fluid pressure measured immediately before inlet and after outlet of an hydraulic component.
Rated Flow	Quantity of fluid (measured in liters per minute) flowing through the quick release coupling associated with a pressure drop (DP) of 0.2 MPa.
Residual Pressure	It is due to the fluid entrapped into the quick release coupling or in the hoses before it, once that valves have been closed.
Safety Sleeve	Auxiliary sleeve acting as a safety device by locking the main sleeve, in order to prevent accidental and unintentional disconnection due for instance to hoses vibrations.
Size	It indicates the nominal size of a quick release coupling, usually reported as an adimensional number (Dash size).
Spillage	The fluid volume (in cubic centimetres) being spilled from the quick release coupling during connection and disconnection.
Static Pressure	Pressure value in steady conditions, when it is constant or has slight fluctuations around its average. In hydraulic circuits it generates mechanical resistance stress on couplers. Added to Dynamic Pressure it results in Total Pressure of the fluid.
Viscosity	Fluid property related to fluid resististance while flowing through the quick release coupling. It is due to fluid chemical structure and physical properties. The coefficient of viscosity increases when temperature level decreases.

Size

Size		
dash	mm	inch
02	3,2	1/8
04	6,3	1/4
06	10	3/8
08	12,5	1/2
09	14,3	9/16
10	16	5/8
12	20	3/4
16	25	1
20	31,5	1-1/4
24	37,5	1-1/2
32	50	2

Conversion table

Flow	Force	Length	Pressure	Torque	Volume	Weight
1 CFM = 28.317 L/min	1 lbf = 0.454 kp	1 ft = 12.000 inch	1 atm = 1.013 bar	1 kpm = 7.233 lbfft	1 ft3 = 6.229 gluk	1 g = 0.001 Kg
1 CFM = 0.472 ls	1 lbf = 4.448 newton	1 ft = 0.305 m	1 atm = 0.101 MPa	1 kpm = 9.807 NNm	1 ft3 = 7.481 glus	1 g = 0.002 lb
1 CFM = 1.699 m3h		1 ft = 304.800 mm	1 atm = 14.696 PSI		1 ft3 = 28.317 liter	1 g = 0.035 oz
1 CFM = 6.229 gpmuk	1 kp = 2.205 lbf		1 atm = 1.033 kp-cm2	1 lbfft = 0.138 kpm	1 ft3 = 0.028 m3	
1 CFM = 7.481 gpmus	1 kp = 9.807 newton	1 inch = 0.083 ft		1 lbfft = 1.356 NNm		1 Kg = 1,000.000 g
		1 inch = 0.025 m	1 bar = 0.987 atm		1 gluk = 0.161 ft3	1 Kg = 2.205 lb
1 L/min = 0.035 CFM	1 newton = 0.225 lbf	1 inch = 25.400 mm	1 bar = 0.100 MPa	1 NNm = 0.102 kpm	1 gluk = 1.201 glus	1 Kg = 35.274 oz
1 L/min = 0.017 ls	1 newton = 0.102 kp		1 bar = 14.504 PSI	1 NNm = 0.738 lbfft	1 gluk = 4.546 liter	
1 L/min = 0.060 m3h		1 m = 3.281 ft	1 bar = 1.020 kp-cm2		1 gluk = 0.005 m3	1 lb = 453.592 g
1 L/min = 0.220 gpmuk		1 m = 39.370 inch				1 lb = 0.454 Kg
1 L/min = 0.264 gpmus		1 m = 1,000.000 mm	1 MPa = 9.869 atm		1 gluk = 0.134 ft3	1 lb = 16.000 oz
			1 MPa = 10.000 bar		1 gluk = 0.833 gluk	
1 ls = 2.119 CFM		1 mm = 0.003 ft	1 MPa = 145.038 PSI		1 gluk = 3.785 liter	1 oz = 28.350 g
1 ls = 60.000 L/min		1 mm = 0.039 inch	1 MPa = 10.197 kp-cm2		1 gluk = 0.004 m3	1 oz = 0.028 Kg
1 ls = 3.600 m3h		1 mm = 0.001 m				1 oz = 0.063 lb
1 ls = 13.198 gpmuk			1 PSI = 0.068 atm		1 liter = 0.035 ft3	
1 ls = 15.850 gpmus			1 PSI = 0.069 bar		1 liter = 0.220 gluk	
			1 PSI = 0.007 MPa		1 liter = 0.264 glus	
1 m3h = 0.589 CFM			1 PSI = 0.070 kp-cm2		1 liter = 0.001 m3	
1 m3h = 16.667 L/min						
1 m3h = 0.278 ls			1 kp-cm2 = 0.981 bar		1 m3 = 35.315 ft3	
1 m3h = 3.666 gpmuk			1 kp-cm2 = 0.098 MPa		1 m3 = 219.969 gluk	
1 m3h = 4.403 gpmus			1 kp-cm2 = 14.223 PSI		1 m3 = 264.172 glus	
			1 kp-cm2 = 0.968 atm		1 m3 = 1,000.000 liter	

Temperature

Seal compound	Faster PN Suffix	Temperature Range [°C]	Temperature range [°F]
NBR (Nitrile rubber)	-	- 25°C / + 125°C	- 13°F / + 257°F
HNBR (NBR Hydrogen)	H	- 25°C / + 140°C	- 13°F / + 284°F
Polyurethane	U	- 25°C / + 100°C	- 13°F / + 212°F
EPDM	E	- 40°C / + 150°C	- 40°F / +302°F
Neoprene	N	- 40°C / + 120°C	- 40°F / + 248°F
FKM (Viton®)	V	- 20°C / + 200°C	- 4°F / +392°F
PTFE (Teflon®)	P	- 200°C / + 260°C	- 328°F / + 500°F
FFKM (Kalrez®)	K	- 15°C / + 315°C	+5°F / + 599°F

Coupler Selection

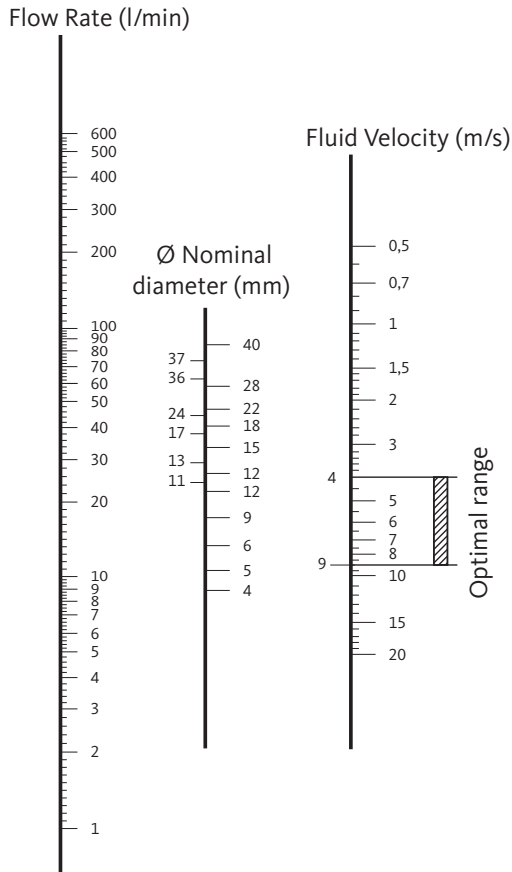

To select the most suitable coupling size for a specific desired flow rate, fluid velocity must be taken into account.

Referring to diagram shown in picture, once identified the required flow rate, you have to draw a line that reaches the advised value of velocity (we recommend keeping the fluid velocity between 3-9 m/s, optimal value: 4-5 m/s).

The line crosses the central column in correspondence with the nominal diameter.

After choosing the product series that is most suitable to coupler application, pick the coupling size corresponding to the nominal diameter value.

EXAMPLE:

Required flow = 40 l/min

Nominal Diameter = 13 mm @ fluid velocity = 5m/s

Coupling Size = 12.5 mm (1/2")

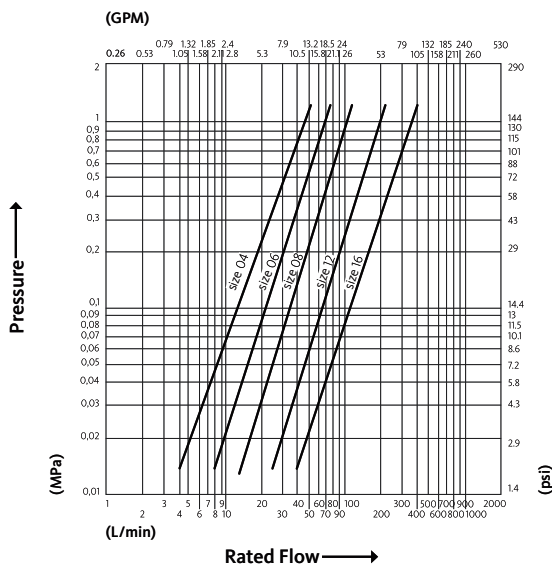

Faster catalog includes double-logarithmic scale diagrams, which show pressure drop in relation to flow rate for each type of coupling and for each available size.

Diagrams are results of tests performed by Faster according to the ISO 18869 normative, therefore can be used to determine the Rated Flow value setting a 0.2 MPa pressure drop.

Rated Flow is used for preliminary sizing of Quick Release Couplings, and it is specified in Technical Data tabs available for each Faster product series.

Thread Faster - standard

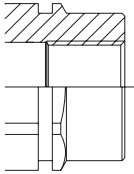
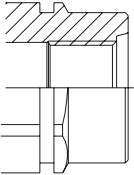
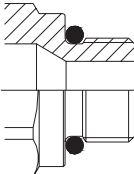
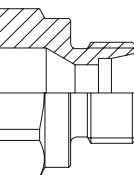
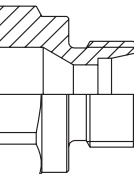
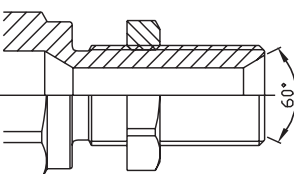
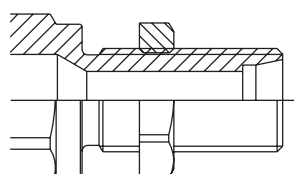
Code	Drawing	Description	Thread	Standards
F		Standard female thread	BSP	ISO 1179-1
			METRIC	ISO 9974-1
			NPT	ANSI B1.20.3
			JPT	JIS B 0203
			Rc	EN10226-2
0/		Female thread O-ring boss (ORB)	BSP	BS 5380
			METRIC	ISO 6149-1
			UN (SAE)	ISO11926-1
1/		Male thread heavy duty (metric), light duty (SAE), taper (NPT)	BSP	BS 5380
			METRIC	ISO 6149-2
			UN (SAE) NPT	ISO 11926-3
				ANSI B1.20.3
2/		24° cone male thread light duty (L)	METRIC	ISO 8434-1 L
3/		24° cone male thread heavy duty (S)	METRIC	ISO 8434-1 L
4/		60° cone male thread bulkhead	BSP	ISO 8434-6
			METRIC	BS 5200
				DIN 3863 (int)
				DIN 3853-L (ext)
5/		24° cone male thread light duty (L) bulkhead	METRIC	ISO 8434-1 L

Thread Faster - standard

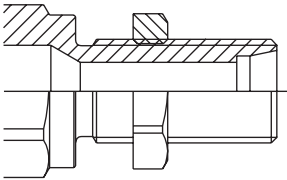
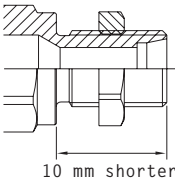
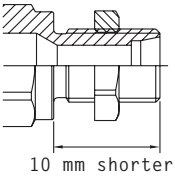
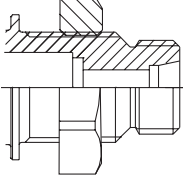
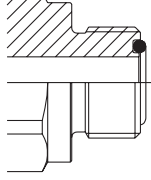
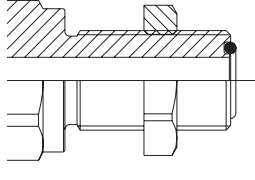
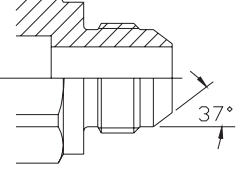
Code	Drawing	Description	Thread	Standards
6/		24° cone male thread heavy duty (S) bulkhead	METRIC	ISO 8434-1 S
7/		24° cone male thread light duty (L) bulkhead 10 mm shorter	METRIC	ISO 8434-1 L
8/		24° cone male thread heavy duty (S) bulkhead 10 mm shorter	METRIC	ISO 8434-1 S
9/		24° cone male double thread light duty (L) bulkhead	METRIC	ISO 8434-1 L
				ISO 5676
11/		O-ring face seal male thread (ORFS)	UN (SAE)	ISO 8434-3
12/		O-ring face seal male thread (ORFS) bulkhead	UN (SAE)	ISO 8434-3
13/		37° flared male thread (JIC)	UN (SAE)	ISO 8434-2

Thread Faster - standard

Code	Drawing	Description	Thread	Standards
14/		37° flared male thread (JIC) bulkhead	UN (SAE)	ISO 8434-2
16/		60° cone male thread	BSP	ISO 8434-6
			METRIC	BS 5200
				DIN 3863 (int)
				DIN 3853-L (ext)
17/		O-ring face seal male double thread (ORFS) bulkhead	UN (SAE)	ISO 8434-3
19/		Hollow screw for ring type nipples	METRIC	DIN 7642
				DIN 7643
20/		Rotating adapter female thread with 60° conical sealing surface	BSP	ISO 8434-6
				BS 5200
21/		Stud end with elastomeric sealing (type E), heavy duty (S)	BSP	ISO 1179-2 ISO 9974-2
			METRIC	
22/		Stud end with sealing by washer	BSP	BS 5200
			METRIC	DIN 3852-1

Thread Faster - standard

Code	Drawing	Description	Thread	Standards
23/		Stud end with metal to metal sealing (type B)	BSP	ISO 1179-4
			METRIC	ISO 9974-3
27/		Not rotating female thread for ORFS stud end	UN (SAE)	ISO 8434-3
28/		Not rotating female thread for 37° flared male	UN (SAE)	ISO 8434-2
29/		Rotating female thread for 37° flared male	UN (SAE)	ISO 8434-2
33/		Hose barb type B	-	-
34/		SAE flange connector for use at 35MPa to 40MPa	UN (SAE)	ISO 6162-2 type 2
35/		Rotating female thread for ORFS stud end	UN (SAE)	ISO 8434-3

Thread Faster - standard

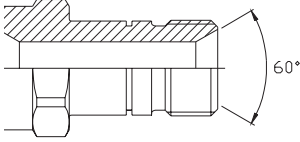
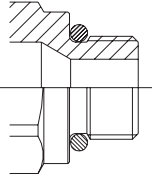
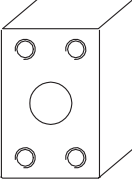
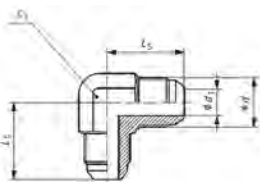
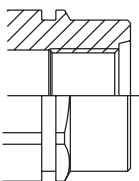
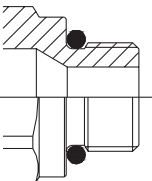
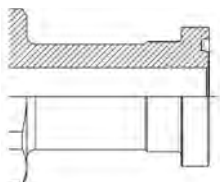
Code	Drawing	Description	Thread	Standards
36/		Male thread ogive 60° panel mouting	BSP	ISO 8434-6
				BS 5200
41/		Male thread light duty (metric), heavy duty (SAE)	METRIC	ISO 6149-3
			UN (SAE)	ISO 11926-2
44/		Metric flange connector for use at 35MPa to 40MPa	METRIC	ISO 6162-2
61/		37° flared male thread (JIC elbow style (90°)	UN (SAE)	ISO 8434-2
71/		Female thread O-ring boss (ORB)	BSP	JIS B 2351
			METRIC	
74/		Male thread	BSP	JIS B 2351
			METRIC	
76/		Flanged head for metric flange clamp for use at 35MPa to 40MPa	UN (SAE)	ISO62-262) 6162-2

Legend	
1	Recommended
2	Suff. satisfactory
3	Unsatisfactory

Fluid compatibility

Fluid	Seals							Materials		
	NBR	CR	EPDM	AU	FKM Viton	FFKM kalrez	PTFE Teflon	Brass	Steel	AISI 316 Stainless Steel
Water	1	2	1	1	2	1	1	1	3	1
Bromine water	3	3	2	3	1	1	1	3	3	3
Salt water	1	3	1	3	1	1	1	3	2	1
Turpentine	1	3	3	3	1	1	1	3	2	1
Carbon dioxide (dry)	1	2	1	1	2	1	1	1	2	1
Carbon dioxide (wet)	1	1	1	1	1	1	1	1	2	1
Air (100°C)	1	1	1	3	1	1	1	1	2	1
Air (150°C)	2	2	2	3	1	1	1	1	2	1
Air (200°C)	3	3	3	3	1	1	1	1	2	1
Nitrogen	1	1	1	1	1	1	1	1	1	1
ASTM A fuel	1	2	3	1	1	1	1	1	1	1
ASTM B fuel	1	3	3	2	1	1	1	1	1	1
ASTM C fuel	2	3	3	3	1	1	1	1	1	1
Kerosene	1	2	3	2	1	1	1	1	1	1
Freon 12	1	1	3	1	2	3	1	1	1	2
Freon 13	1	1	1	1	1	3	1	1	1	1
Freon 134 A	1	1	2	3	3	3	1	1	1	1
Propane (liquefied gas)	1	2	3	1	1	1	1	1	1	1
Glycol	1	1	1	3	1	1	1	3	1	1
Brakes fluid (petroleum base)	1	2	3	1	3	1	1	1	1	1
Brakes fluid (synthetic base)	3	3	1	2	3	1	1	1	1	1
Carbon monoxide	1	1	1	1	1	1	1	1	1	1
Mineral oils	1	2	3	1	1	1	1	1	1	1
Animal oil (lard)	1	2	2	1	1	1	1	2	1	1
ASTM oil n° 1	1	1	3	1	1	1	1	1	1	1
ASTM oil n° 2	1	2	3	2	1	1	1	1	1	1
ASTM oil n° 3	1	3	3	2	1	1	1	1	1	1
ASTM oil n° 4	2	3	3	3	1	1	1	1	1	1
Peanut oil	1	3	3	2	1	1	1	2	1	1
Cottonseed oil	1	3	3	1	1	1	1	3	1	1
Cod-liver oil	1	2	1	1	1	1	1	1	1	1
Tung oil (china wood oil)	1	2	3	3	1	1	1	1	1	1
Linseed oil	1	3	3	2	1	1	1	3	1	1
Corn oil	1	3	3	1	1	1	1	2	1	1
Olive oil	1	2	2	1	1	1	1	2	1	1
Castor oil	1	1	2	1	1	1	1	1	1	1
Soybean oil	1	3	3	2	1	1	1	2	1	1
Diesel oil	1	3	3	3	1	1	1	1	1	1
Hydraulic oil (petroleum base)	1	1	3	1	1	1	1	1	1	1
SAE 10 20 30 40 50 lubr. oils	1	2	3	2	1	1	1	1	1	1
Automatic transmission fluid	1	2	3	3	1	1	1	1	1	1
Heating fuel (carbon base)	3	3	3	2	1	1	1	3	1	1
Heating fuel (petroleum base)	1	2	3	2	1	1	1	3	1	1
Silicone oil	1	1	1	1	1	1	1	1	1	1
Transformer oil	1	2	3	1	1	1	1	1	1	1
Oxygen (liquid)	2	1	1	1	1	1	2	1	1	1
Oxygen (100°C.. 200°C))	3	3	3	1	2	1	2	1	1	1
Hydrogen peroxide 10%	2	3	2	2	1	1	1	3	3	1
Hydrogen peroxide 30%	3	3	2	2	1	1	1	3	3	1
Hydrogen peroxide 70%	3	3	2	2	1	1	1	3	3	1
Hydrogen peroxide 90%	3	3	3	2	1	1	1	3	3	1
Quintolubric 822	1	1	3	1	1	1	1	1	1	1
Quintolubric 870-68	1	2	3	1	1	1	1	1	1	1
Steam (< 200°C)	3	3	1	3	3	1	1	2	1	1
Steam (> 200°C)	3	3	3	3	3	1	1	2	1	1

Instructions and warnings for couplings

Recommendations

- Improper use and incorrect maintenance of products with high internal working pressures could cause malfunctioning and damage to persons and machines. Therefore it is necessary to carefully conform to the simple instructions contained in this website and catalogue. For any further information please contact Faster® R&D Dept.
- Before using a new quick-release coupling, please carefully check all data reported in our website, dedicate instructions and catalogues.
- Make sure that the coupling is suitable for pressure, flow characteristics, oil compatibility, proper machine installation and so on requested by the applications. In order to allow your best application understanding please use our Product Definition Form as a guideline.
- Lubricate the seals and perform a connection and disconnection operation in order to check the perfect functioning of the coupling.
- Verify that threads fit and that their sealing is correct.
- If necessary replace damaged components with Faster® original spare parts only.
- Before any connection and disconnection carefully clean both male and female parts to prevent dirt inclusions into the circuit with consequent seals damage and hydraulic fluid contamination. When couplings are disconnected, please protect them with original Faster® dust plugs.
- During the first applications of the coupling, be sure that none is in the nearby and test the coupling under the maximum working pressure when connected and disconnected.
- The most critical moment using flat-face couplings takes place during the coupling phase when the valve in the male part moves and causes an internal volume reduction.
- This fact causes a pressure increase due to the oil quantity existing in the plant. Furthermore, during that operation, the sealing action of the seal in male part has to shift from the male valve to the female.
- In order to resist to internal stresses, Faster® has designed the male couplings of 3FFH... series, equipped with patented triple valve, using this technology it is possible to connect with a residual pressure of 35 MPa (5076 PSI) in male part using standard female couplings FFH series.

Warnings

- When a disconnection is performed, there could be a residual pressure that depending on temperature and position, could reach high values especially using couplers equipped with the breakaway function. This prevents opening the valve in the male part and as a consequence, the connection is not possible.

- Avoid forcing the coupling male valve to decrease residual pressure.
- Use female part suitable for connection under pressure.
- Do not use any sharpened or improper tools which could damage the seals when opening the valves.
- Avoid to install couplers using it as a support for hoses or other devices, the quick release coupler is not a support or a hook, strong side loads may cause damages and malfunctioning to the product.

Responsibilities

- The recommendations stated here do not consider all risk factors in every possible application of Faster® couplings and multiconnections.
- The final choice of the product is under customer's responsibility who has to make the selection according to Faster® suggestions.
- The customer has to make sure that all requirements of chosen parts are respected, efficiency is maintained and the end user is informed about use and maintenance operations.
- Faster® and its Distributors are not responsible for damages to persons and machines caused by an improper use and an incorrect maintenance of products.
- Continuous improvement of technical features of products is Faster's policy. For that reason all data in this website and catalogues are not binding. Faster® is entitled to modify the specifications without prior notice.

Guarantee

- All Faster® quick-release couplings are designed and produced in conformity with the regulations of Quality Managing System according to UNI EN ISO 9001 Standards.
- They bear the Faster® logo to guarantee their origin and reliability.
- Faster® quick-release couplings are distributed worldwide through a network of highly qualified distributors.
- If a Faster® quick-release coupling is connected to a correspondent competitor's type please check the functionality, the sealing and the resistance to working pressure before using the coupling.
- Faster can not assure the performance, quality and connecting tolerances of competitor's types.
- Malfunctioning or leakages due to the above mentioned cases could cause serious damages to persons and machines.

Instructions and warnings for Multifaster

Recommendations

- Before using a new MultiFaster, please carefully consider all data and indications reported in our website and catalogue. Make sure that your MultiFaster is suitable to the flow and pressure used during the application.
- Working pressure must be verified on each single coupling and then on the total of the lines.
- Carefully check that all lines under the maximum working pressure simultaneously do not exceed the maximum working pressure value indicated in our website or catalogue.
- Make lines simultaneously under pressure alternate with lines that are not under pressure to ensure a longer lifetime to the seals.
- Please carefully read the instructions packed with the MultiFaster system (instruction no. 55). Lubricate all points subjected to frictions and wear as indicated in the instruction no. 55, perform some connection and disconnection operations in order to check the perfect functioning of the system. Replace MultiFaster components only with original marked Faster® spare parts as indicated in the schedules of this catalogue and in the instructions of the MultiFaster.
- Clean the fixed and the mobile parts of the system before each connection to preserve seals.
- When the MultiFaster is not connected, please protect the fixed part with the special automatic dust cover and place the mobile part on its support (on request) to prevent dirt contamination and dents.

Warnings

- Improper use and incorrect maintenance of products with high internal working pressures could cause malfunctioning and damage to persons and machines. Therefore it is necessary to carefully conform to the instructions contained in this website, catalogue or in the single products. For any further information please contact Faster® R&D Dept.
- Connection and disconnection of MultiFaster is carried out by a lever. This system minimizes the force to connect even with plant at maximum working pressure. Therefore it is necessary to verify all operating conditions in view of the system on which the MultiFaster will be fitted.
- For 2P series MultiFaster (equipped with 2FFNP male couplings), to calculate the maximum pressure during the coupling phase, consider that there is a volume reduction inside the male part by:
2cc-size 06
3cc-size 08
7cc-size 12
this volume reduction creates a pressure increase in addition to the oil quantity existing in the system, male circuit.

- For 3P series MultiFaster (equipped with 3FFNP male couplings), the internal pressure is constant.
- Damages in the seals and internal components of the coupling may occur if connecting phase is carried out at higher pressures than stated values thus causing loss of oil and malfunctioning.
- In case of damages, ask for original Faster® spare parts kits. Check that all moveable components are cleaned and greased. Be sure that safety nut is released by each connecting operation to avoid any accidental disconnection caused by vibrations or shocks.
- During the disconnection with the MultiFaster under pressure ensure to hold the lever with a hand to avoid that the fast return could cause damage to persons and machines.

Responsibilities

- The recommendations stated here do not consider all risk factors in every possible application of Faster® couplings and multiconnections.
- The final choice of the product is under customer's responsibility who has to make the selection according to Faster® suggestions.
- The customer has to make sure that all requirements of chosen parts are respected, efficiency is maintained and the end user is informed about use and maintenance operations.
- Faster® and its Distributors are not responsible for damages to persons and machines caused by an improper use and an incorrect maintenance of products.
- Continuous improvement of technical features of products is Faster's policy. For that reason all data in this website and catalogues are not binding. Faster® is entitled to modify the specifications without prior notice.

Guarantee

- All Faster® quick-release couplings are designed and produced in conformity with the regulations of Quality Managing System according to UNI EN ISO 9001 Standards.
- They bear the Faster® logo to guarantee their origin and reliability.
- Faster® quick-release couplings are distributed worldwide through a network of highly qualified distributors.
- If a Faster® quick-release coupling is connected to a correspondent competitor's type please check the functionality, the sealing and the resistance to working pressure before using the coupling.
- Faster can not assure the performance, quality and connecting tolerances of competitor's types.
- Malfunctioning or leakages due to the above mentioned cases could cause serious damages to persons and machines.

Index

PRODUCT	SECTION	PAGE
AGRI	Agriculture	53
ANV	Agriculture	49
CFPV	Agriculture	65
CNV	Agriculture	69
CPV	Agriculture	59
CPVN	Agriculture	63
CVC	Screw to Connect	167
CVE	Screw to Connect	171
CVLS	Screw to Connect	165
CVV	Screw to Connect	159
DF	Check Valves and Diagnostic	203
FB	Screw to Connect	187
FFC	Flat Face	143
FFH	Flat Face	121
FFHP	High Pressure	211
FHV	Flat Face	147
FHV IP	Flat Face	153
FHV K	Flat Face	155
FHVFR	BOP	221
Flex Cart	Casting Solutions	267
FPI	Agriculture	117
FSH	Flat Face	129
HNV	Sleeve Retraction	23
HNV brass	Sleeve Retraction	27
HNV stainless steel	Sleeve Retraction	31
HNVFR	BOP	219
HNVN	Sleeve Retraction	35
Manifold blocks	Casting Solutions	271
MultiGrease	MultiFaster Standard	307
NL	Sleeve Retraction	17
NS	Sleeve Retraction	13
NV	Sleeve Retraction	7

PRODUCT	SECTION	PAGE
NV stainless steel	Sleeve Retraction	11
OGF	Flat Face	145
OGV	Screw to Connect	189
OGVFR	BOP	223
OGVST	Screw to Connect	191
P1004	MultiFaster Standard	333
P10A	MultiFaster Standard	335
P12A	MultiFaster Standard	337
P12B	MultiFaster Standard	339
P1504	MultiFaster Standard	341
P206	MultiFaster Standard	283
P206G	MultiFaster G Type	353
P208	MultiFaster Standard	285
P208G	MultiFaster G Type	355
P306	MultiFaster Standard	287
P316	MultiFaster Standard	289
P404	MultiFaster Standard	291
P406A	MultiFaster Standard	293
P412	MultiFaster Standard	295
P506	MultiFaster Standard	297
P506-x	MultiFaster Standard	299
P5065	MultiFaster Harvesting	349
P5066	MultiFaster Standard	321
P5068	MultiFaster Standard	329
P506G	MultiFaster G Type	357
P508	MultiFaster Standard	303
P508G	MultiFaster G Type	359
P510	MultiFaster Standard	309
P510G	MultiFaster G Type	361
P606	MultiFaster Standard	323
P608	MultiFaster Standard	325
P608G	MultiFaster G Type	363

PRODUCT	SECTION	PAGE
P808	MultiFaster Standard	331
P808G	MultiFaster G Type	365
PB06	MultiFaster Standard	279
PC206	MultiFaster Standard	281
PH216S	MultiFaster High Pressure	371
PH406S	MultiFaster High Pressure	373
PH408S	MultiFaster High Pressure	375
PH510S	MultiFaster High Pressure	377
PLK	MultiFaster Harvesting	347
PLV	MultiFaster Harvesting	345
PS	Agriculture	57
PS06	MultiFaster Standard	313
PS06-x	MultiFaster Standard	315
PS08	MultiFaster Standard	319
PSA06	MultiFaster Standard	317
PV	Agriculture	55
PVSM	High Pressure	209
PVVM	High Pressure	207
RF	Refrigeration	227
RFCS	Refrigeration	231
RFL	Refrigeration	235
RFLS-RFS	Refrigeration	237
SV	Sleeve Retraction	21
TNL	Sleeve Retraction	43
TNL brass	Sleeve Retraction	45
TNV	Sleeve Retraction	39
UHP 100	High Pressure	213
UHP 150	High Pressure	215
VA	Agriculture	109
VF	Agriculture	111
VU	Check Valves and Diagnostic	195
VUC	Check Valves and Diagnostic	199

PRODUCT	SECTION	PAGE
VV	Screw to Connect	173
VVM	Screw to Connect	185
VVS	Screw to Connect	177
VVS stainless steel	Screw to Connect	181
2FFI brass	Flat Face	137
2FFI stainless steel	Flat Face	139
2FSI - FFI	Flat Face	135
2NS	Agriculture	75
2NV	Agriculture	73
3CFHF	Agriculture	83
3CKHF	Agriculture	87
3CNV	Agriculture	77
3CPV	Agriculture	81
3FFH	Flat Face	131
3NV	Agriculture	79
4BD4FH	Casting Solutions	265
4BD4FH Cartridges replacement kit	Casting Solutions	274
4CPV	Agriculture	93
4DCPV	Casting Solutions	269
4HNV	Sleeve Retraction	37
4NV	Agriculture	95
4PV	Agriculture	91
4SKHF	Agriculture	103
4SRHF	Agriculture	99
5BM5DCPV	Casting Solutions	273
5FPI	Agriculture	115
6DNPV	Agriculture	107

Notes

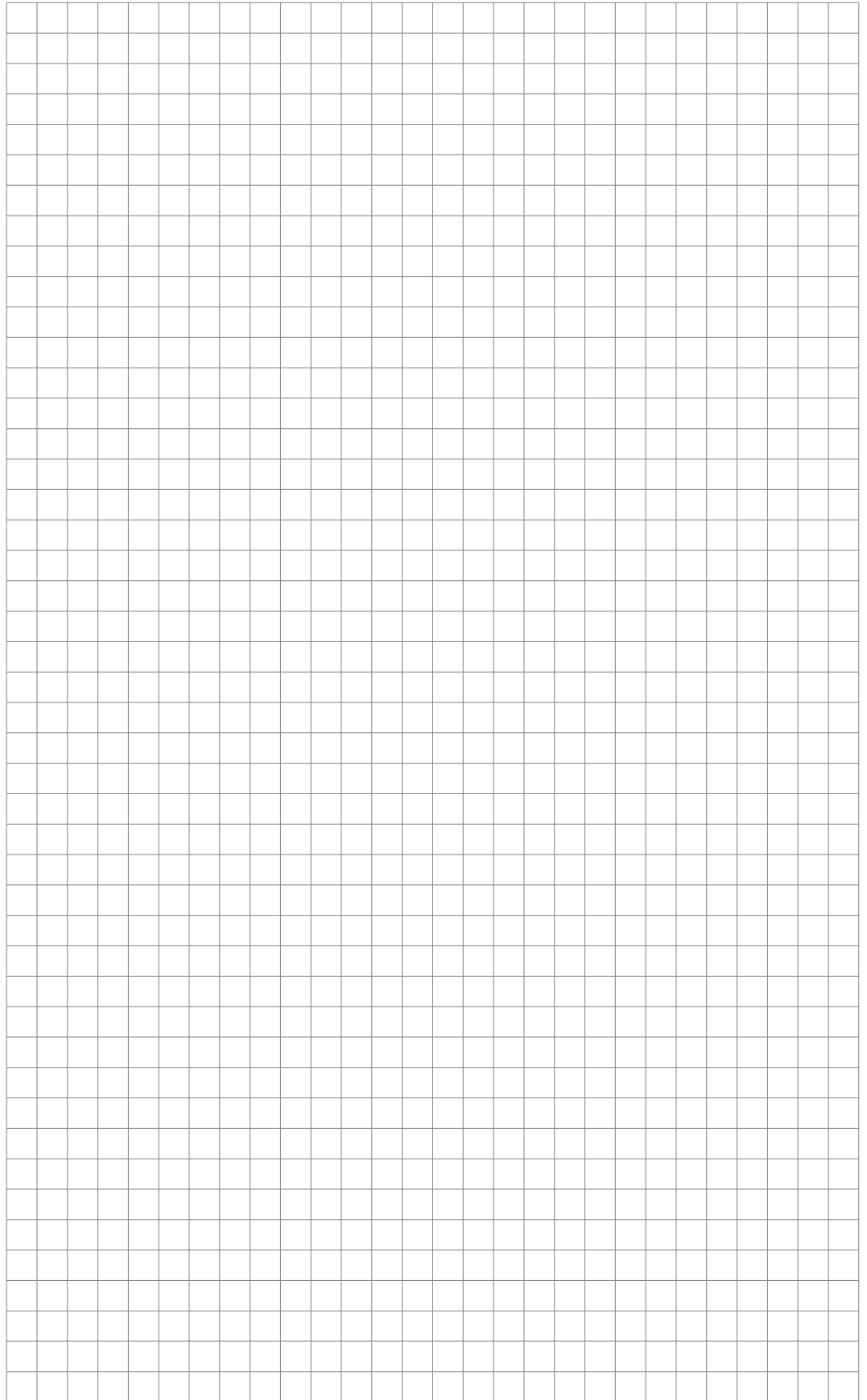

Notes

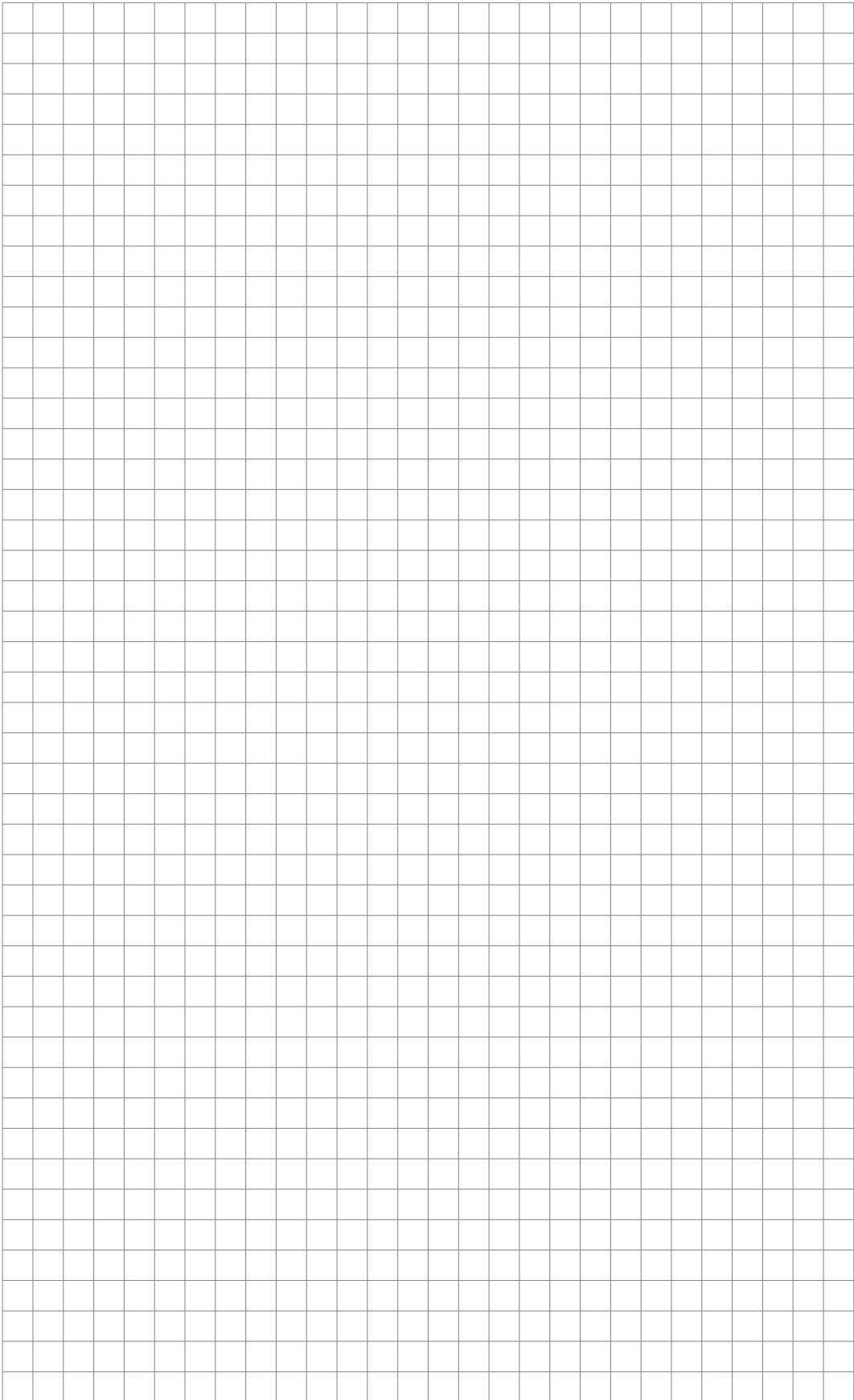

Notes



Notes

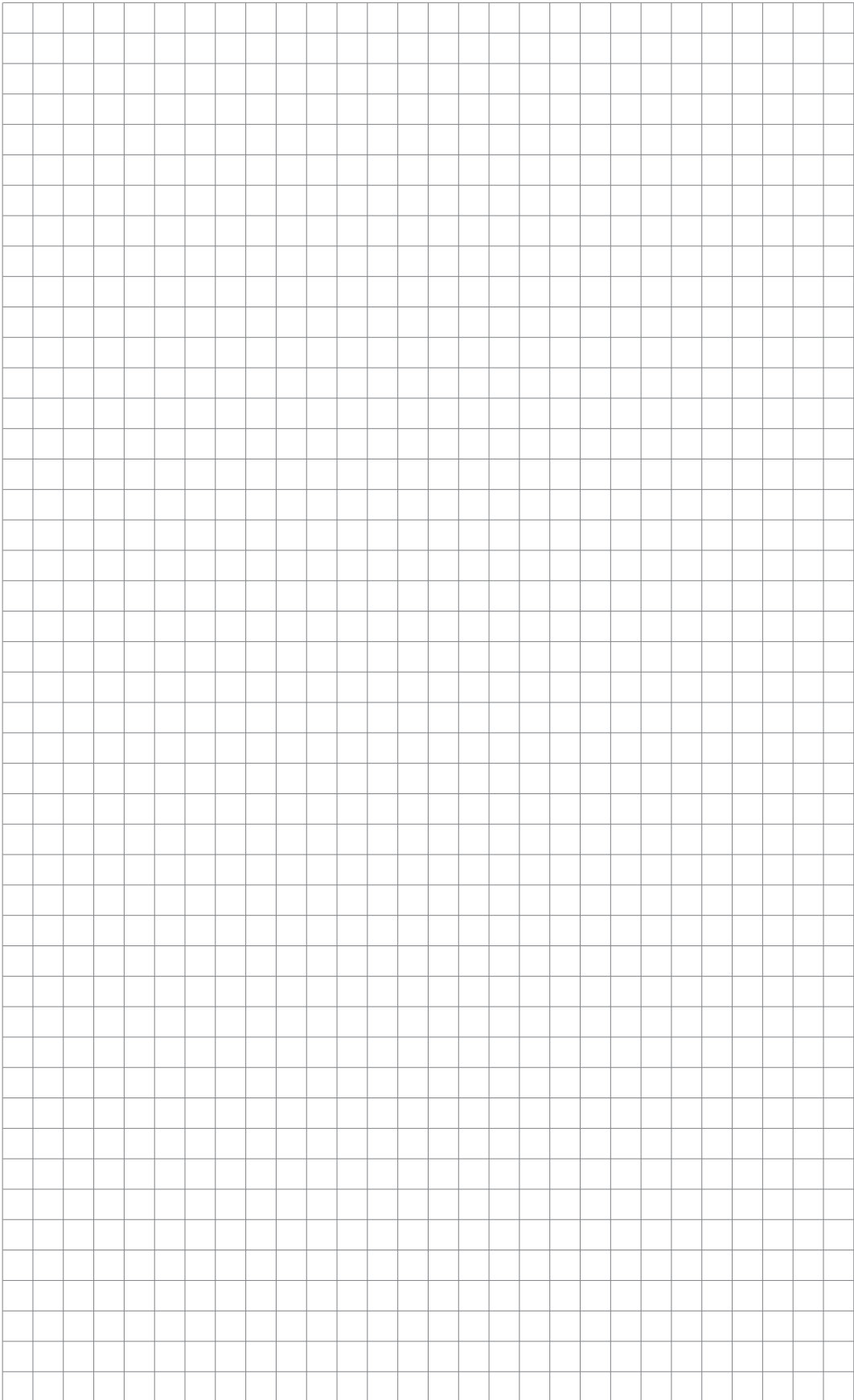

Notes

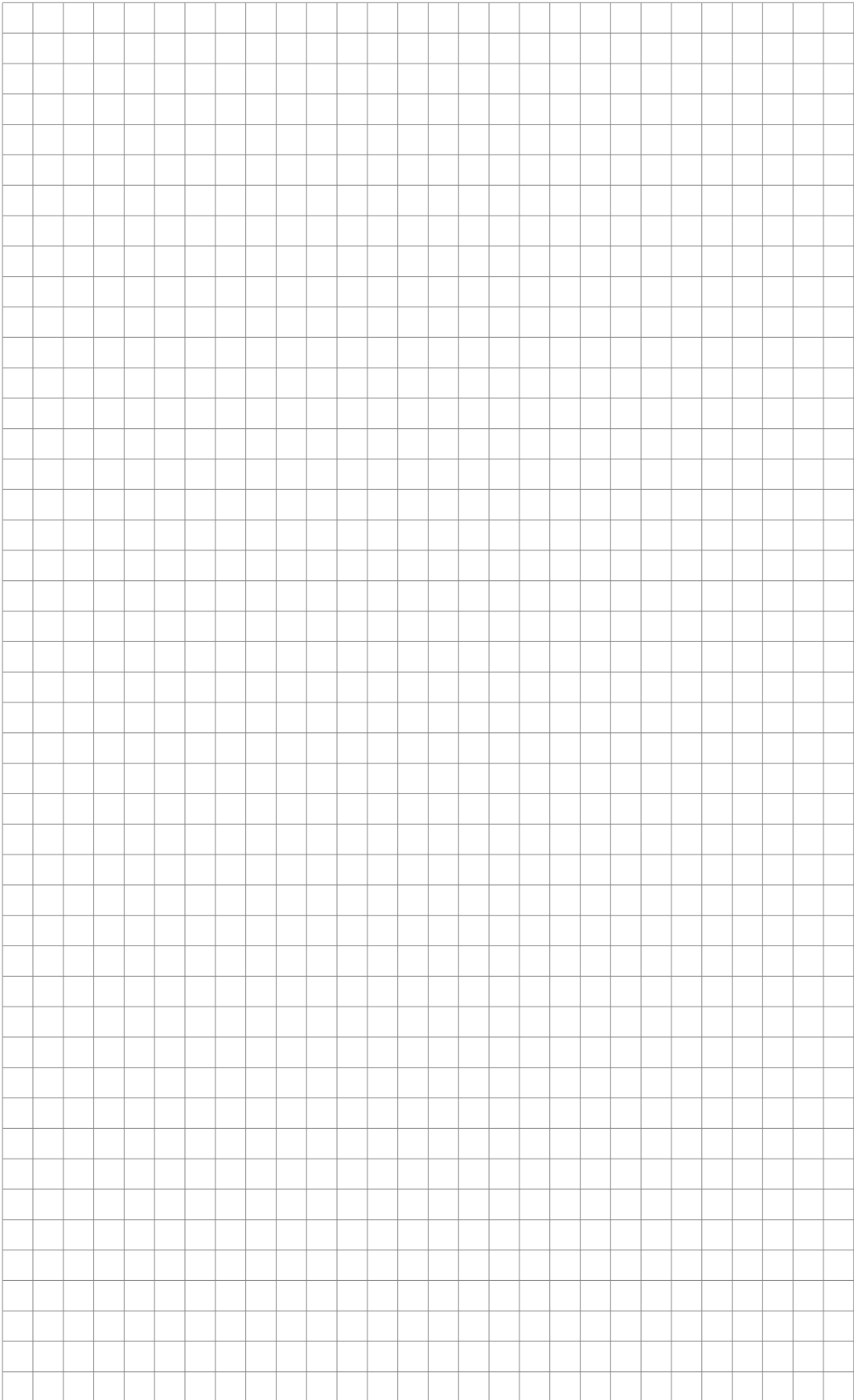

The information contained in this catalog is for general information purposes only. The information is provided by Faster srl. while we endeavour to keep the information up to date and correct, we make no representations or warranties of any kind, express or implied, about the completeness, accuracy, reliability, suitability or availability with respect to the information, products, or related pictures/graphics here contained for any purpose. Any reliance you place on such information is therefore strictly at your own risk.

Faster: the global reference in quick-release hydraulic couplings

Headquarter: Faster Srl

Via Ludovico Ariosto, 7
26027 Rivolta d'Adda
CR, Italy

Germany: Faster Germany GmbH

Ursulaweg 39
40764 Langenfeld

Usa: Faster Inc

6560 Weatherfield Court Maumee
OH - 43537, Usa

Brazil: Faster do Brasil

R. José Franklin de Moura, 25 - Independência,
Taubaté - SP

China: Faster Hydraulics Co Ltd

Rm 102, Bld 23, No. 588, Xin Jun Huan Rd. Pujiang
Hi-Tech Park, 201114
Shanghai P.R. China

India: Faster Hydraulics Pvt Ltd

Plot n°10, Gate N°108 Ambethan,
Taluka Khed. District Pune, Maharastra
410501 India

fastercouplings.com